



**NON-IONIZING RADIATION,
PART 2: RADIOFREQUENCY
ELECTROMAGNETIC FIELDS**

VOLUME 102

IARC MONOGRAPHS
ON THE EVALUATION
OF CARCINOGENIC RISKS
TO HUMANS

NON-IONIZING RADIATION, PART 2: RADIOFREQUENCY ELECTROMAGNETIC FIELDS

VOLUME 102

This publication represents the views and expert opinions of an IARC Working Group on the Evaluation of Carcinogenic Risks to Humans, which met in Lyon, 24-31 May 2011

LYON, FRANCE - 2013

IARC MONOGRAPHS
ON THE EVALUATION
OF CARCINOGENIC RISKS
TO HUMANS

IARC MONOGRAPHS

In 1969, the International Agency for Research on Cancer (IARC) initiated a programme on the evaluation of the carcinogenic risk of chemicals to humans involving the production of critically evaluated monographs on individual chemicals. The programme was subsequently expanded to include evaluations of carcinogenic risks associated with exposures to complex mixtures, lifestyle factors and biological and physical agents, as well as those in specific occupations. The objective of the programme is to elaborate and publish in the form of monographs critical reviews of data on carcinogenicity for agents to which humans are known to be exposed and on specific exposure situations; to evaluate these data in terms of human risk with the help of international working groups of experts in chemical carcinogenesis and related fields; and to indicate where additional research efforts are needed. The lists of IARC evaluations are regularly updated and are available on the Internet at <http://monographs.iarc.fr/>.

This programme has been supported since 1982 by Cooperative Agreement U01 CA33193 with the United States National Cancer Institute, Department of Health and Human Services. Additional support has been provided since 1986 by the Health, Safety and Hygiene at Work Unit of the European Commission Directorate-General for Employment, Social Affairs and Equal Opportunities, and since 1992 by the United States National Institute of Environmental Health Sciences, Department of Health and Human Services. The contents of this volume are solely the responsibility of the Working Group and do not necessarily represent the official views of the U.S. National Cancer Institute, the U.S. National Institute of Environmental Health Sciences, the U.S. Department of Health and Human Services, or the European Commission Directorate-General for Employment, Social Affairs and Equal Opportunities.

This volume was made possible, in part, through Cooperative Agreement CR 834012 with the United States Environmental Protection Agency, Office of Research and Development. The contents of this volume do not necessarily reflect the views or policies of the U.S. Environmental Protection Agency.

Published by the International Agency for Research on Cancer,
150 cours Albert Thomas, 69372 Lyon Cedex 08, France
©International Agency for Research on Cancer, 2012

Distributed by WHO Press, World Health Organization, 20 Avenue Appia, 1211 Geneva 27, Switzerland
(tel.: +41 22 791 3264; fax: +41 22 791 4857; e-mail: bookorders@who.int).

Publications of the World Health Organization enjoy copyright protection in accordance with the provisions of Protocol 2 of the Universal Copyright Convention. All rights reserved.

The International Agency for Research on Cancer welcomes requests for permission to reproduce or translate its publications, in part or in full. Requests for permission to reproduce or translate IARC publications – whether for sale or for noncommercial distribution – should be addressed to WHO Press, at the above address (fax: +41 22 791 4806; email: permissions@who.int).

The designations employed and the presentation of the material in this publication do not imply the expression of any opinion whatsoever on the part of the Secretariat of the World Health Organization concerning the legal status of any country, territory, city, or area or of its authorities, or concerning the delimitation of its frontiers or boundaries.

The mention of specific companies or of certain manufacturers' products does not imply that they are endorsed or recommended by the World Health Organization in preference to others of a similar nature that are not mentioned. Errors and omissions excepted, the names of proprietary products are distinguished by initial capital letters.

The IARC Monographs Working Group alone is responsible for the views expressed in this publication.

IARC Library Cataloguing in Publication Data

Non-ionizing radiation, Part II: Radiofrequency electromagnetic fields / IARC Working Group on the Evaluation of Carcinogenic Risks to Humans (2011: Lyon, France)

(IARC monographs on the evaluation of carcinogenic risks to humans ; v. 102)

1. Electromagnetic Fields – adverse effects 2. Neoplasms – etiology 3. Radiation, Nonionizing
4. Radio Waves – adverse effects

I. IARC Working Group on the Evaluation of Carcinogenic Risks to Humans II. Series

ISBN 978 92 832 1325 3
ISSN 1017-1606

(NLM Classification: W1)

PRINTED IN FRANCE

CONTENTS

NOTE TO THE READER	1
LIST OF PARTICIPANTS	3
PREAMBLE.....	9
A. GENERAL PRINCIPLES AND PROCEDURES	9
1. Background.....	9
2. Objective and scope.....	10
3. Selection of agents for review	11
4. Data for the <i>Monographs</i>	11
5. Meeting participants.....	12
6. Working procedures.....	13
B. SCIENTIFIC REVIEW AND EVALUATION.....	14
1. Exposure data.....	15
2. Studies of cancer in humans	16
3. Studies of cancer in experimental animals.....	20
4. Mechanistic and other relevant data.....	23
5. Summary.....	26
6. Evaluation and rationale.....	27
References	31
GENERAL REMARKS.....	33
1. EXPOSURE DATA	37
1.1 Introduction	37
1.1.1 Electromagnetic radiation	37
1.1.2 The electromagnetic spectrum.....	38
1.1.3 Exposures to EMF.....	38
1.2 Sources of exposure	41
1.2.1 Natural fields	41
1.2.2 Man-made fields.....	45

1.3	Dosimetry	68
1.3.1	Introduction.....	68
1.3.2	Dosimetric exposure.....	68
1.3.3	Coupling of incident fields with the body.....	71
1.3.4	Dependence on local anatomy.....	73
1.3.5	Estimation of local tissue temperature based on psSAR	74
1.3.6	Dosimetry methods	75
1.3.7	Exposure set-ups for laboratory studies.....	77
1.3.8	Exposure characterization in laboratory studies.....	78
1.3.9	Biological factors in studies in experimental animals	79
1.4	Measurement techniques.....	87
1.4.1	Introduction.....	87
1.4.2	Near-field and dosimetric probes.....	87
1.4.3	Measurement antennae	89
1.4.4	Temperature instrumentation	89
1.4.5	Measuring SAR and the near field	91
1.4.6	Incident-field measurements in the far field	91
1.4.7	Broadband measurements.....	92
1.4.8	Calibration	94
1.4.9	Uncertainty assessment.....	94
1.4.10	Specific measurement problems	95
1.5	Interaction of RF-EMF with biological systems.....	97
1.5.1	Thermal effects.....	98
1.5.2	Physiological effects	99
1.5.3	Magnetic-field effects.....	103
1.5.4	Conclusion	104
1.6	Exposure to RF radiation.....	104
1.6.1	Personal exposure	104
1.6.2	Occupational exposure	111
1.6.3	Environmental exposure.....	112
1.7	Exposure guidelines and standards	115
1.7.1	Scientific basis.....	115
1.7.2	Basic restrictions.....	116
1.7.3	Reference levels	117
	References	118

2. CANCER IN HUMANS	129
2.1 Occupational exposure	129
2.1.1 Cancer of the brain	130
2.1.2 Leukaemia and lymphoma	147
2.1.3 Uveal (ocular) melanoma	156
2.1.4 Cancer of the testis	156
2.1.5 Other cancers	157
2.2 Environmental exposure from fixed-site transmitters	158
2.2.1 Cancer of the brain	158
2.2.2 Leukaemia and lymphoma	174
2.2.3 Other cancers	186
2.3 Exposure from mobile phones	187
2.3.1 Cancer of the brain	192
2.3.2 Leukaemia and lymphoma	234
2.3.3 Uveal (ocular) melanoma	242
2.3.4 Cancer of the testis	242
2.3.5 Cancers of the parotid gland	249
2.3.6 Other cancers	250
References	251
3. CANCER IN EXPERIMENTAL ANIMALS	257
3.1 Studies of carcinogenicity	257
3.1.1 Mouse	257
3.1.2 Rat	257
3.1.3 Transgenic and tumour-prone models	262
3.2 Initiation–promotion studies	265
3.2.1 Skin-tumour model	265
3.2.2 Lymphoma model	274
3.2.3 Mammary-gland tumour model	274
3.2.4 Brain-tumour model	275
3.3 Co-carcinogenesis	277
References	281

4. OTHER RELEVANT DATA.....	285
4.1 Genetic and related effects	285
4.1.1 Humans	285
4.1.2 Experimental systems: <i>in vivo</i>	290
4.1.3 Experimental systems: <i>in vitro</i>	301
4.2 Effects of low-level exposure to RF radiation on the immune system	329
4.2.1 Immunotropic effects of exposure to RF radiation in humans.....	329
4.2.2 Immunotropic effects of exposure to RF radiation in experimental animals	330
4.2.3 Immunotropic effects of exposure to RF radiation in experimental systems.....	333
4.3 Effects of exposure to RF radiation on gene and protein expression	337
4.3.1 Gene expression.....	377
4.3.2 Protein expression.....	345
4.4 Other relevant effects	360
4.4.1 Humans	360
4.4.2 Experimental systems: <i>in vivo</i>	363
4.4.3 Experimental systems: <i>in vitro</i>	369
4.5 Physical factors that affect interpretation of study results	383
4.5.1 Effects of critical RF-field parameters	383
4.5.2 Frequency dependence and frequency windows	384
4.5.3 Polarization	384
4.5.4 Dose and duration of exposure.....	384
4.5.5 Background fields of extremely low frequency (ELF)	384
4.5.6 Net static geomagnetic field	385
References.....	385
5. SUMMARY OF DATA REPORTED.....	405
5.1 Exposure data	405
5.2 Human carcinogenicity data	407
5.2.1 Personal use of wireless telephones	407
5.2.2 Occupational exposure	410
5.2.3 Environmental exposure	412
5.3 Animal carcinogenicity data	413
5.4 Other relevant data	414
5.4.1 Genetic and related effects of exposure	414
5.4.2 Reaction of the immune system after exposure	415
5.4.3 Effects on genes, proteins and signalling pathways	416
5.4.4 Other mechanistic end-points.....	416

6. EVALUATION	419
6.1 Cancer in humans	419
6.2 Cancer in experimental animals.....	419
6.3 Overall evaluation.....	419
6.4 Rationale of the evaluation of the epidemiological evidence.....	419
GLOSSARY	421
LIST OF ABBREVIATIONS	427
CUMULATIVE CROSS INDEX TO IARC MONOGRAPHS	429

NOTE TO THE READER

The term ‘carcinogenic risk’ in the *IARC Monographs* series is taken to mean that an agent is capable of causing cancer. The *Monographs* evaluate cancer hazards, despite the historical presence of the word ‘risks’ in the title.

Inclusion of an agent in the *Monographs* does not imply that it is a carcinogen, only that the published data have been examined. Equally, the fact that an agent has not yet been evaluated in a *Monograph* does not mean that it is not carcinogenic. Similarly, identification of cancer sites with *sufficient evidence* or *limited evidence* in humans should not be viewed as precluding the possibility that an agent may cause cancer at other sites.

The evaluations of carcinogenic risk are made by international working groups of independent scientists and are qualitative in nature. No recommendation is given for regulation or legislation.

Anyone who is aware of published data that may alter the evaluation of the carcinogenic risk of an agent to humans is encouraged to make this information available to the Section of IARC Monographs, International Agency for Research on Cancer, 150 cours Albert Thomas, 69372 Lyon Cedex 08, France, in order that the agent may be considered for re-evaluation by a future Working Group.

Although every effort is made to prepare the *Monographs* as accurately as possible, mistakes may occur. Readers are requested to communicate any errors to the Section of IARC Monographs, so that corrections can be reported in future volumes.

LIST OF PARTICIPANTS

Members ¹

Bruce Armstrong

Sydney School of Public Health
University of Sydney
Sydney, NSW
Australia

Igor Y. Belyaev

Cancer Research Institute
Slovak Academy of Science
Bratislava
Slovakia

Carl F. Blackman

Raleigh, NC
USA

Maria Blettner

Institute of Medical Biometry, Epidemiology
and Informatics
University of Mainz
Mainz
Germany

Elisabeth Cardis

Center for Research in Environmental
Epidemiology (CREAL)
Barcelona
Spain

Clemens Dasenbrock

Toxicology & Environmental Hygiene
Fraunhofer Institute for Toxicology
and Experimental Medicine
Hanover
Germany

¹ Working Group Members and Invited Specialists serve in their individual capacities as scientists and not as representatives of their government or any organization with which they are affiliated. Affiliations are provided for identification purposes only. Invited Specialists do not serve as meeting chair or subgroup chair, draft text that pertains to the description or interpretation of cancer data, or participate in the evaluations.

Each participant was asked to disclose pertinent research, employment, and financial interests. Current financial interests and research and employment interests during the past 4 years or anticipated in the future are identified here. Minor pertinent interests are not listed and include stock valued at no more than US\$1000 overall, grants that provide no more than 5% of the research budget of the expert's organization and that do not support the expert's research or position, and consulting or speaking on matters not before a court or government agency that does not exceed 2% of total professional time or compensation. All grants that support the expert's research or position and all consulting or speaking on behalf of an interested party on matters before a court or government agency are listed as significant pertinent interests.

Etienne Degrave [retired] (not present for final evaluations)

Department of Well-Being
Belgian Ministry of Defence
Brussels
Belgium

René de Seze²

Experimental Toxicology Unit
INERIS
Verneuil-en-Halatte
France

Jean-François Doré

Oncogenesis and Tumour Progression
INSERM
Léon Bérard Centre
Lyon
France

Lennart Hardell

Department of Oncology
University Hospital
Örebro
Sweden

Peter D. Inskip (not present for final evaluations)

Division of Cancer Epidemiology
and Genetics
National Cancer Institute
Bethesda, MD
USA

Jukka Juutilainen

Department of Environmental Science
University of Eastern Finland
Kuopio
Finland

Nam Kim

Chungbuk National University
School of Electrical and Computer
Engineering
Cheongju
Republic of Korea

Dariusz Leszczynski

Radiation and Nuclear Safety Authority
Helsinki
Finland

Simon Mann

Centre for Radiation, Chemical
and Environmental Hazards
Health Protection Agency
Didcot
England

David L. McCormick (Subgroup Chair, Cancer in Experimental Animals)

IIT Research Institute
Chicago, IL
USA

²René de Seze received significant research support (more than €100 000, ceased in 2009) from Fondation Santé et Radiofréquences, a research foundation created under the leadership of the French Ministry of Research and with public interest status. Half of the budget is state funded, the other half is provided by industry. The Foundation's independence and the transparency of its operations are guaranteed by its Ethics Charter. In 2009, René de Seze prepared a report for a plaintiff's lawyer on the association between radiofrequency fields and brain cancer.

James McNamee

Consumer & Clinical Radiation
Protection Bureau
Health Canada
Ottawa, ON
Canada

*Christopher J. Portier (Subgroup Chair,
Mechanistic and Other Relevant Data)*

National Center for Environmental Health
& Agency for Toxic Substances and Disease
Registry
Centers for Disease Control and Prevention
Atlanta, GA
USA

*Ronald Melnick (Subgroup Chair, Exposure
Data)*

Ron Melnick Consulting
Chapel Hill, NC
USA

David B. Richardson

Department of Epidemiology
University of North Carolina
Chapel Hill, NC
USA

*Meike Mevissen*³

Division of Veterinary Pharmacology
and Toxicology
University of Bern
Bern
Switzerland

*Martin Rösli*⁴

Unit for Environmental Epidemiology
and Health Risk Assessment
Swiss Tropical and Public Health Institute
Basel
Switzerland

Junji Miyakoshi

Research Institute for Sustainable
Humanosphere
Kyoto University
Kyoto
Japan

Jonathan M. Samet (Meeting Chair)

Institute for Global Health
University of Southern California
Los Angeles, CA
USA

³Meike Mevissen receives research funding for gene-pathway effects of radiofrequency electromagnetic fields from Forschungsstiftung Mobilfunk, a non-profit-making research foundation at ETH Zurich. Neither industry, nor non-governmental organizations are represented on the scientific board of the foundation.

⁴Martin Rösli receives research funding for studies on adverse health effects of mobile-phone use from Forschungsstiftung Mobilfunk, a non-profit-making research foundation at ETH Zurich. Neither industry, nor nongovernmental organizations are represented on the scientific board of the foundation. He also serves as a member on the board of this foundation.

Tomoyuki Shirai [retired]

Department of Experimental Pathology
and Tumor Biology
Nagoya City University
Nagoya
Japan

*Luc Verschaeve*⁶

Department of Toxicology
Scientific Institute of Public Health
Brussels
Belgium

Jack Siemiatycki (Subgroup Chair, Cancer in Humans)

Department of Social and Preventive
Medicine
University of Montreal
Montreal, QC
Canada

Vijayalaxmi

Department of Radiology
University of Texas Health Science Center
San Antonio, TX
USA

*Malcolm Sim*⁵

Monash Centre for Occupational
and Environmental Health
Monash University
Melbourne, VIC
Australia

Invited Specialists

*Anders Ahlbom*⁷ [withdrew]

Institute of Environmental Medicine
Karolinska Institute
Stockholm
Sweden

Stanislaw Szmigielski [did not attend]

Department of Microwave Safety
Military Institute of Hygiene and
Epidemiology
Warsaw
Poland

*Niels Kuster*⁸

IT'IS Foundation for Research on Information
Technologies in Society
Zurich
Switzerland

⁵ Malcolm Sim owns stock (less than €5000) in Telstra, an Australian telecommunication-service provider.

⁶ Luc Verschaeve's research institute received a small research grant (less than €5000, ceased in March 2011) from the GSM Operators Forum on environmental effects of mobile-phone base stations.

⁷ Anders Ahlbom served (until May 2011) on the Board of Directors of Gunnar Ahlbom AB, a consulting firm in the domains of European Union affairs, especially within telecommunications.

⁸ Niels Kuster is Director and Board member of the non-profit IT'IS Foundation that performs exposure assessments for industry and governments, and also President of the Board and shareholder of Near-Field Technology AG, a holding controlling two companies, SPEAG and ZMT, that are active in the development of near-field measurement instruments, simulation software and medical-test equipment.

Representatives

Laurent Bontoux

European Commission
Directorate General for Health
and Consumers
Brussels
Belgium

Katja Bromen

European Commission
Directorate General for Health
and Consumers
Brussels
Belgium

Hamadi Dekhil

National Agency for the Control of Health
and Environmental Products
Tunis
Tunisia

Clara Galland

French Agency for Food, Environment
and Occupational Health Safety (ANSES)
Maisons-Alfort
France

David Gee [did not attend]

European Environment Agency
Copenhagen
Denmark

Olivier Merckel

French Agency for Food, Environment
and Occupational Health Safety (ANSES)
Maisons-Alfort
France

Observers ⁹

Joe A. Elder ¹⁰

Plantation, FL
USA

Claire Marrant

Department of Cancer and the Environment
Léon Bérard Centre
Lyon
France

Robert Nuttall

Canadian Cancer Society
Toronto, ON
Canada

⁹ Each Observer agreed to respect the Guidelines for Observers at IARC Monographs meetings. Observers did not serve as meeting chair or subgroup chair, draft any part of a Monograph, or participate in the evaluations. They also agreed not to contact participants before the meeting, not to lobby them at any time, not to send them written materials, and not to offer them meals or other favours. IARC asked and reminded Working Group Members to report any contact or attempt to influence that they may have encountered, either before or during the meeting.

¹⁰ Joe Elder is self-employed as a radiofrequency bioeffects consultant. He was employed by Motorola (until 2009) and his wife holds stock in Motorola. His participation as an Observer in this IARC Monographs meeting is sponsored by the Mobile Manufacturers Forum representing manufacturers of mobile and wireless communication devices and the network infrastructure that supports them.

*Jack Rowley*¹¹

Research and Sustainability
GSM Association
London
England

*Mays L. Swicord*¹²

Key Largo, FL
USA

IARC Secretariat

Robert Baan (*Responsible Officer*)
Lamia Benbrahim-Tallaa (*Rapporteur, Mechanistic and Other Relevant Data*)
Véronique Bouvard (*Rapporteur, Exposure Data*)
Graham Byrnes
Rafael Carel (*Visiting Scientist*)
Isabelle Deltour (*Visiting Scientist*)
Fatih El Ghissassi (*Rapporteur, Mechanistic and Other Relevant Data*)
Laurent Galichet (*Scientific Editor*)
Nicolas Gaudin
Yann Grosse (*Rapporteur, Cancer in Experimental Animals*)
Neela Guha (*Rapporteur, Cancer in Humans*)
Farhad Islami
Ausrele Kesminiene
Béatrice Lauby-Secretan
Aslak Harbo Poulsen (*Visiting Scientist*)
Monika Moissonier
Rodolfo Saracci
Joachim Schüz
Kurt Straif (*Head of Programme*)
Emilie van Deventer, WHO Geneva

Post-meeting Assistance

Heidi Mattock (*Scientific Editor*)

Anthony B. Miller
Toronto, ON
Canada

Administrative Assistance

Sandrine Egraz
Michel Javin
Brigitte Kajo
Helene Lorenzen-Augros
Annick Papin
Karine Racinoux

Production Team

Elisabeth Elbers
Dorothy Russell

¹¹ Jack Rowley is employed by the GSM Association whose member companies use radiofrequency radiation to deliver communication services. He has represented the GSM Association in government inquiries in North America and at workshops organized by the European Commission and national authorities. His participation as an Observer in this IARC Monographs meeting is sponsored by the GSM Association.

¹² Mays Swicord worked as a consultant for Motorola (until 2008). His participation as an Observer in this IARC Monographs meeting is sponsored by CTIA – The Wireless Association.

PREAMBLE

The Preamble to the *IARC Monographs* describes the objective and scope of the programme, the scientific principles and procedures used in developing a *Monograph*, the types of evidence considered and the scientific criteria that guide the evaluations. The Preamble should be consulted when reading a *Monograph* or list of evaluations.

A. GENERAL PRINCIPLES AND PROCEDURES

1. Background

Soon after IARC was established in 1965, it received frequent requests for advice on the carcinogenic risk of chemicals, including requests for lists of known and suspected human carcinogens. It was clear that it would not be a simple task to summarize adequately the complexity of the information that was available, and IARC began to consider means of obtaining international expert opinion on this topic. In 1970, the IARC Advisory Committee on Environmental Carcinogenesis recommended ‘...that a compendium on carcinogenic chemicals be prepared by experts. The biological activity and evaluation of practical importance to public health should be referenced and documented.’ The IARC Governing Council adopted a resolution concerning the role of IARC in providing government authorities with expert, independent, scientific opinion on environmental carcinogenesis. As one means to that end, the Governing Council recommended that IARC should prepare monographs on the evaluation of carcinogenic

risk of chemicals to man, which became the initial title of the series.

In the succeeding years, the scope of the programme broadened as *Monographs* were developed for groups of related chemicals, complex mixtures, occupational exposures, physical and biological agents and lifestyle factors. In 1988, the phrase ‘of chemicals’ was dropped from the title, which assumed its present form, *IARC Monographs on the Evaluation of Carcinogenic Risks to Humans*.

Through the *Monographs* programme, IARC seeks to identify the causes of human cancer. This is the first step in cancer prevention, which is needed as much today as when IARC was established. The global burden of cancer is high and continues to increase: the annual number of new cases was estimated at 10.1 million in 2000 and is expected to reach 15 million by 2020 ([Stewart & Kleihues, 2003](#)). With current trends in demographics and exposure, the cancer burden has been shifting from high-resource countries to low- and medium-resource countries. As a result of *Monographs* evaluations, national health agencies have been able, on scientific grounds, to take measures to reduce human exposure to carcinogens in the workplace and in the environment.

The criteria established in 1971 to evaluate carcinogenic risks to humans were adopted by the Working Groups whose deliberations resulted in the first 16 volumes of the *Monographs* series. Those criteria were subsequently updated by further ad hoc Advisory Groups ([IARC, 1977, 1978, 1979, 1982, 1983, 1987, 1988, 1991](#); [Vainio et al., 1992](#); [IARC, 2005, 2006](#)).

The Preamble is primarily a statement of scientific principles, rather than a specification of working procedures. The procedures through which a Working Group implements these principles are not specified in detail. They usually involve operations that have been established as being effective during previous *Monograph* meetings but remain, predominantly, the prerogative of each individual Working Group.

2. Objective and scope

The objective of the programme is to prepare, with the help of international Working Groups of experts, and to publish in the form of *Monographs*, critical reviews and evaluations of evidence on the carcinogenicity of a wide range of human exposures. The *Monographs* represent the first step in carcinogen risk assessment, which involves examination of all relevant information to assess the strength of the available evidence that an agent could alter the age-specific incidence of cancer in humans. The *Monographs* may also indicate where additional research efforts are needed, specifically when data immediately relevant to an evaluation are not available.

In this Preamble, the term ‘agent’ refers to any entity or circumstance that is subject to evaluation in a *Monograph*. As the scope of the programme has broadened, categories of agents now include specific chemicals, groups of related chemicals, complex mixtures, occupational or environmental exposures, cultural or behavioural practices, biological organisms and physical agents. This list of categories may expand as

causation of, and susceptibility to, malignant disease become more fully understood.

A cancer ‘hazard’ is an agent that is capable of causing cancer under some circumstances, while a cancer ‘risk’ is an estimate of the carcinogenic effects expected from exposure to a cancer hazard. The *Monographs* are an exercise in evaluating cancer hazards, despite the historical presence of the word ‘risks’ in the title. The distinction between hazard and risk is important, and the *Monographs* identify cancer hazards even when risks are very low at current exposure levels, because new uses or unforeseen exposures could engender risks that are significantly higher.

In the *Monographs*, an agent is termed ‘carcinogenic’ if it is capable of increasing the incidence of malignant neoplasms, reducing their latency, or increasing their severity or multiplicity. The induction of benign neoplasms may in some circumstances (see Part B, Section 3a) contribute to the judgement that the agent is carcinogenic. The terms ‘neoplasm’ and ‘tumour’ are used interchangeably.

The Preamble continues the previous usage of the phrase ‘strength of evidence’ as a matter of historical continuity, although it should be understood that *Monographs* evaluations consider studies that support a finding of a cancer hazard as well as studies that do not.

Some epidemiological and experimental studies indicate that different agents may act at different stages in the carcinogenic process, and several different mechanisms may be involved. The aim of the *Monographs* has been, from their inception, to evaluate evidence of carcinogenicity at any stage in the carcinogenesis process, independently of the underlying mechanisms. Information on mechanisms may, however, be used in making the overall evaluation ([IARC, 1991](#); [Vainio et al., 1992](#); [IARC, 2005, 2006](#); see also Part B, Sections 4 and 6). As mechanisms of carcinogenesis are elucidated, IARC convenes international scientific conferences to determine whether a broad-based consensus has emerged

on how specific mechanistic data can be used in an evaluation of human carcinogenicity. The results of such conferences are reported in IARC Scientific Publications, which, as long as they still reflect the current state of scientific knowledge, may guide subsequent Working Groups.

Although the *Monographs* have emphasized hazard identification, important issues may also involve dose–response assessment. In many cases, the same epidemiological and experimental studies used to evaluate a cancer hazard can also be used to estimate a dose–response relationship. A *Monograph* may undertake to estimate dose–response relationships within the range of the available epidemiological data, or it may compare the dose–response information from experimental and epidemiological studies. In some cases, a subsequent publication may be prepared by a separate Working Group with expertise in quantitative dose–response assessment.

The *Monographs* are used by national and international authorities to make risk assessments, formulate decisions concerning preventive measures, provide effective cancer control programmes and decide among alternative options for public health decisions. The evaluations of IARC Working Groups are scientific, qualitative judgements on the evidence for or against carcinogenicity provided by the available data. These evaluations represent only one part of the body of information on which public health decisions may be based. Public health options vary from one situation to another and from country to country and relate to many factors, including different socioeconomic and national priorities. Therefore, no recommendation is given with regard to regulation or legislation, which are the responsibility of individual governments or other international organizations.

3. Selection of agents for review

Agents are selected for review on the basis of two main criteria: (a) there is evidence of human

exposure and (b) there is some evidence or suspicion of carcinogenicity. Mixed exposures may occur in occupational and environmental settings and as a result of individual and cultural habits (such as tobacco smoking and dietary practices). Chemical analogues and compounds with biological or physical characteristics similar to those of suspected carcinogens may also be considered, even in the absence of data on a possible carcinogenic effect in humans or experimental animals.

The scientific literature is surveyed for published data relevant to an assessment of carcinogenicity. Ad hoc Advisory Groups convened by IARC in 1984, 1989, 1991, 1993, 1998 and 2003 made recommendations as to which agents should be evaluated in the *Monographs* series. Recent recommendations are available on the *Monographs* programme web site (<http://monographs.iarc.fr>). IARC may schedule other agents for review as it becomes aware of new scientific information or as national health agencies identify an urgent public health need related to cancer.

As significant new data become available on an agent for which a *Monograph* exists, a re-evaluation may be made at a subsequent meeting, and a new *Monograph* published. In some cases it may be appropriate to review only the data published since a prior evaluation. This can be useful for updating a database, reviewing new data to resolve a previously open question or identifying new tumour sites associated with a carcinogenic agent. Major changes in an evaluation (e.g. a new classification in Group 1 or a determination that a mechanism does not operate in humans, see Part B, Section 6) are more appropriately addressed by a full review.

4. Data for the *Monographs*

Each *Monograph* reviews all pertinent epidemiological studies and cancer bioassays in experimental animals. Those judged inadequate

or irrelevant to the evaluation may be cited but not summarized. If a group of similar studies is not reviewed, the reasons are indicated.

Mechanistic and other relevant data are also reviewed. A *Monograph* does not necessarily cite all the mechanistic literature concerning the agent being evaluated (see Part B, Section 4). Only those data considered by the Working Group to be relevant to making the evaluation are included.

With regard to epidemiological studies, cancer bioassays, and mechanistic and other relevant data, only reports that have been published or accepted for publication in the openly available scientific literature are reviewed. The same publication requirement applies to studies originating from IARC, including meta-analyses or pooled analyses commissioned by IARC in advance of a meeting (see Part B, Section 2c). Data from government agency reports that are publicly available are also considered. Exceptionally, doctoral theses and other material that are in their final form and publicly available may be reviewed.

Exposure data and other information on an agent under consideration are also reviewed. In the sections on chemical and physical properties, on analysis, on production and use and on occurrence, published and unpublished sources of information may be considered.

Inclusion of a study does not imply acceptance of the adequacy of the study design or of the analysis and interpretation of the results, and limitations are clearly outlined in square brackets at the end of each study description (see Part B). The reasons for not giving further consideration to an individual study also are indicated in the square brackets.

5. Meeting participants

Five categories of participant can be present at *Monograph* meetings.

(a) *The Working Group*

The Working Group is responsible for the critical reviews and evaluations that are developed during the meeting. The tasks of Working Group Members are: (i) to ascertain that all appropriate data have been collected; (ii) to select the data relevant for the evaluation on the basis of scientific merit; (iii) to prepare accurate summaries of the data to enable the reader to follow the reasoning of the Working Group; (iv) to evaluate the results of epidemiological and experimental studies on cancer; (v) to evaluate data relevant to the understanding of mechanisms of carcinogenesis; and (vi) to make an overall evaluation of the carcinogenicity of the exposure to humans. Working Group Members generally have published significant research related to the carcinogenicity of the agents being reviewed, and IARC uses literature searches to identify most experts. Working Group Members are selected on the basis of (a) knowledge and experience and (b) absence of real or apparent conflicts of interests. Consideration is also given to demographic diversity and balance of scientific findings and views.

(b) *Invited Specialists*

Invited Specialists are experts who also have critical knowledge and experience but have a real or apparent conflict of interests. These experts are invited when necessary to assist in the Working Group by contributing their unique knowledge and experience during subgroup and plenary discussions. They may also contribute text on non-influential issues in the section on exposure, such as a general description of data on production and use (see Part B, Section 1). Invited Specialists do not serve as meeting chair or subgroup chair, draft text that pertains to the description or interpretation of cancer data, or participate in the evaluations.

(c) *Representatives of national and international health agencies*

Representatives of national and international health agencies often attend meetings because their agencies sponsor the programme or are interested in the subject of a meeting. Representatives do not serve as meeting chair or subgroup chair, draft any part of a *Monograph*, or participate in the evaluations.

(d) *Observers with relevant scientific credentials*

Observers with relevant scientific credentials may be admitted to a meeting by IARC in limited numbers. Attention will be given to achieving a balance of Observers from constituencies with differing perspectives. They are invited to observe the meeting and should not attempt to influence it. Observers do not serve as meeting chair or subgroup chair, draft any part of a *Monograph*, or participate in the evaluations. At the meeting, the meeting chair and subgroup chairs may grant Observers an opportunity to speak, generally after they have observed a discussion. Observers agree to respect the Guidelines for Observers at *IARC Monographs* meetings (available at <http://monographs.iarc.fr>).

(e) *The IARC Secretariat*

The IARC Secretariat consists of scientists who are designated by IARC and who have relevant expertise. They serve as rapporteurs and participate in all discussions. When requested by the meeting chair or subgroup chair, they may also draft text or prepare tables and analyses.

Before an invitation is extended, each potential participant, including the IARC Secretariat, completes the WHO Declaration of Interests to report financial interests, employment and consulting, and individual and institutional research support related to the subject of the meeting. IARC assesses these interests to determine

whether there is a conflict that warrants some limitation on participation. The declarations are updated and reviewed again at the opening of the meeting. Interests related to the subject of the meeting are disclosed to the meeting participants and in the published volume ([Cogliano et al., 2004](#)).

The names and principal affiliations of participants are available on the *Monographs* programme web site (<http://monographs.iarc.fr>) approximately two months before each meeting. It is not acceptable for Observers or third parties to contact other participants before a meeting or to lobby them at any time. Meeting participants are asked to report all such contacts to IARC ([Cogliano et al., 2005](#)).

All participants are listed, with their principal affiliations, at the beginning of each volume. Each participant who is a Member of a Working Group serves as an individual scientist and not as a representative of any organization, government or industry.

6. Working procedures

A separate Working Group is responsible for developing each volume of *Monographs*. A volume contains one or more *Monographs*, which can cover either a single agent or several related agents. Approximately one year in advance of the meeting of a Working Group, the agents to be reviewed are announced on the *Monographs* programme web site (<http://monographs.iarc.fr>) and participants are selected by IARC staff in consultation with other experts. Subsequently, relevant biological and epidemiological data are collected by IARC from recognized sources of information on carcinogenesis, including data storage and retrieval systems such as PubMed. Meeting participants who are asked to prepare preliminary working papers for specific sections are expected to supplement the IARC literature searches with their own searches.

Industrial associations, labour unions and other knowledgeable organizations may be asked to provide input to the sections on production and use, although this involvement is not required as a general rule. Information on production and trade is obtained from governmental, trade and market research publications and, in some cases, by direct contact with industries. Separate production data on some agents may not be available for a variety of reasons (e.g. not collected or made public in all producing countries, production is small). Information on uses may be obtained from published sources but is often complemented by direct contact with manufacturers. Efforts are made to supplement this information with data from other national and international sources.

Six months before the meeting, the material obtained is sent to meeting participants to prepare preliminary working papers. The working papers are compiled by IARC staff and sent, before the meeting, to Working Group Members and Invited Specialists for review.

The Working Group meets at IARC for seven to eight days to discuss and finalize the texts and to formulate the evaluations. The objectives of the meeting are peer review and consensus. During the first few days, four subgroups (covering exposure data, cancer in humans, cancer in experimental animals, and mechanistic and other relevant data) review the working papers, develop a joint subgroup draft and write summaries. Care is taken to ensure that each study summary is written or reviewed by someone not associated with the study being considered. During the last few days, the Working Group meets in plenary session to review the subgroup drafts and develop the evaluations. As a result, the entire volume is the joint product of the Working Group, and there are no individually authored sections.

IARC Working Groups strive to achieve a consensus evaluation. Consensus reflects broad agreement among Working Group Members, but

not necessarily unanimity. The chair may elect to poll Working Group Members to determine the diversity of scientific opinion on issues where consensus is not readily apparent.

After the meeting, the master copy is verified by consulting the original literature, edited and prepared for publication. The aim is to publish the volume within six months of the Working Group meeting. A summary of the outcome is available on the *Monographs* programme web site soon after the meeting.

B. SCIENTIFIC REVIEW AND EVALUATION

The available studies are summarized by the Working Group, with particular regard to the qualitative aspects discussed below. In general, numerical findings are indicated as they appear in the original report; units are converted when necessary for easier comparison. The Working Group may conduct additional analyses of the published data and use them in their assessment of the evidence; the results of such supplementary analyses are given in square brackets. When an important aspect of a study that directly impinges on its interpretation should be brought to the attention of the reader, a Working Group comment is given in square brackets.

The scope of the *IARC Monographs* programme has expanded beyond chemicals to include complex mixtures, occupational exposures, physical and biological agents, lifestyle factors and other potentially carcinogenic exposures. Over time, the structure of a *Monograph* has evolved to include the following sections:

- Exposure data
- Studies of cancer in humans
- Studies of cancer in experimental animals
- Mechanistic and other relevant data
- Summary
- Evaluation and rationale

In addition, a section of General Remarks at the front of the volume discusses the reasons the agents were scheduled for evaluation and some key issues the Working Group encountered during the meeting.

This part of the Preamble discusses the types of evidence considered and summarized in each section of a *Monograph*, followed by the scientific criteria that guide the evaluations.

1. Exposure data

Each *Monograph* includes general information on the agent: this information may vary substantially between agents and must be adapted accordingly. Also included is information on production and use (when appropriate), methods of analysis and detection, occurrence, and sources and routes of human occupational and environmental exposures. Depending on the agent, regulations and guidelines for use may be presented.

(a) *General information on the agent*

For chemical agents, sections on chemical and physical data are included: the Chemical Abstracts Service Registry Number, the latest primary name and the IUPAC systematic name are recorded; other synonyms are given, but the list is not necessarily comprehensive. Information on chemical and physical properties that are relevant to identification, occurrence and biological activity is included. A description of technical products of chemicals includes trade names, relevant specifications and available information on composition and impurities. Some of the trade names given may be those of mixtures in which the agent being evaluated is only one of the ingredients.

For biological agents, taxonomy, structure and biology are described, and the degree of variability is indicated. Mode of replication, life cycle, target cells, persistence, latency, host

response and clinical disease other than cancer are also presented.

For physical agents that are forms of radiation, energy and range of the radiation are included. For foreign bodies, fibres and respirable particles, size range and relative dimensions are indicated.

For agents such as mixtures, drugs or lifestyle factors, a description of the agent, including its composition, is given.

Whenever appropriate, other information, such as historical perspectives or the description of an industry or habit, may be included.

(b) *Analysis and detection*

An overview of methods of analysis and detection of the agent is presented, including their sensitivity, specificity and reproducibility. Methods widely used for regulatory purposes are emphasized. Methods for monitoring human exposure are also given. No critical evaluation or recommendation of any method is meant or implied.

(c) *Production and use*

The dates of first synthesis and of first commercial production of a chemical, mixture or other agent are provided when available; for agents that do not occur naturally, this information may allow a reasonable estimate to be made of the date before which no human exposure to the agent could have occurred. The dates of first reported occurrence of an exposure are also provided when available. In addition, methods of synthesis used in past and present commercial production and different methods of production, which may give rise to different impurities, are described.

The countries where companies report production of the agent, and the number of companies in each country, are identified. Available data on production, international trade and uses are

obtained for representative regions. It should not, however, be inferred that those areas or nations are necessarily the sole or major sources or users of the agent. Some identified uses may not be current or major applications, and the coverage is not necessarily comprehensive. In the case of drugs, mention of their therapeutic uses does not necessarily represent current practice nor does it imply judgement as to their therapeutic efficacy.

(d) *Occurrence and exposure*

Information on the occurrence of an agent in the environment is obtained from data derived from the monitoring and surveillance of levels in occupational environments, air, water, soil, plants, foods and animal and human tissues. When available, data on the generation, persistence and bioaccumulation of the agent are also included. Such data may be available from national databases.

Data that indicate the extent of past and present human exposure, the sources of exposure, the people most likely to be exposed and the factors that contribute to the exposure are reported. Information is presented on the range of human exposure, including occupational and environmental exposures. This includes relevant findings from both developed and developing countries. Some of these data are not distributed widely and may be available from government reports and other sources. In the case of mixtures, industries, occupations or processes, information is given about all agents known to be present. For processes, industries and occupations, a historical description is also given, noting variations in chemical composition, physical properties and levels of occupational exposure with date and place. For biological agents, the epidemiology of infection is described.

(e) *Regulations and guidelines*

Statements concerning regulations and guidelines (e.g. occupational exposure limits, maximal levels permitted in foods and water, pesticide registrations) are included, but they may not reflect the most recent situation, since such limits are continuously reviewed and modified. The absence of information on regulatory status for a country should not be taken to imply that that country does not have regulations with regard to the exposure. For biological agents, legislation and control, including vaccination and therapy, are described.

2. Studies of cancer in humans

This section includes all pertinent epidemiological studies (see Part A, Section 4). Studies of biomarkers are included when they are relevant to an evaluation of carcinogenicity to humans.

(a) *Types of study considered*

Several types of epidemiological study contribute to the assessment of carcinogenicity in humans — cohort studies, case–control studies, correlation (or ecological) studies and intervention studies. Rarely, results from randomized trials may be available. Case reports and case series of cancer in humans may also be reviewed.

Cohort and case–control studies relate individual exposures under study to the occurrence of cancer in individuals and provide an estimate of effect (such as relative risk) as the main measure of association. Intervention studies may provide strong evidence for making causal inferences, as exemplified by cessation of smoking and the subsequent decrease in risk for lung cancer.

In correlation studies, the units of investigation are usually whole populations (e.g. in particular geographical areas or at particular times), and cancer frequency is related to a summary measure of the exposure of the population

to the agent under study. In correlation studies, individual exposure is not documented, which renders this kind of study more prone to confounding. In some circumstances, however, correlation studies may be more informative than analytical study designs (see, for example, the *Monograph on arsenic in drinking-water*; [IARC, 2004](#)).

In some instances, case reports and case series have provided important information about the carcinogenicity of an agent. These types of study generally arise from a suspicion, based on clinical experience, that the concurrence of two events — that is, a particular exposure and occurrence of a cancer — has happened rather more frequently than would be expected by chance. Case reports and case series usually lack complete ascertainment of cases in any population, definition or enumeration of the population at risk and estimation of the expected number of cases in the absence of exposure.

The uncertainties that surround the interpretation of case reports, case series and correlation studies make them inadequate, except in rare instances, to form the sole basis for inferring a causal relationship. When taken together with case-control and cohort studies, however, these types of study may add materially to the judgement that a causal relationship exists.

Epidemiological studies of benign neoplasms, presumed preneoplastic lesions and other end-points thought to be relevant to cancer are also reviewed. They may, in some instances, strengthen inferences drawn from studies of cancer itself.

(b) Quality of studies considered

It is necessary to take into account the possible roles of bias, confounding and chance in the interpretation of epidemiological studies. Bias is the effect of factors in study design or execution that lead erroneously to a stronger or weaker association than in fact exists between an

agent and disease. Confounding is a form of bias that occurs when the relationship with disease is made to appear stronger or weaker than it truly is as a result of an association between the apparent causal factor and another factor that is associated with either an increase or decrease in the incidence of the disease. The role of chance is related to biological variability and the influence of sample size on the precision of estimates of effect.

In evaluating the extent to which these factors have been minimized in an individual study, consideration is given to several aspects of design and analysis as described in the report of the study. For example, when suspicion of carcinogenicity arises largely from a single small study, careful consideration is given when interpreting subsequent studies that included these data in an enlarged population. Most of these considerations apply equally to case-control, cohort and correlation studies. Lack of clarity of any of these aspects in the reporting of a study can decrease its credibility and the weight given to it in the final evaluation of the exposure.

First, the study population, disease (or diseases) and exposure should have been well defined by the authors. Cases of disease in the study population should have been identified in a way that was independent of the exposure of interest, and exposure should have been assessed in a way that was not related to disease status.

Second, the authors should have taken into account — in the study design and analysis — other variables that can influence the risk of disease and may have been related to the exposure of interest. Potential confounding by such variables should have been dealt with either in the design of the study, such as by matching, or in the analysis, by statistical adjustment. In cohort studies, comparisons with local rates of disease may or may not be more appropriate than those with national rates. Internal comparisons of frequency of disease among individuals at different levels of exposure are also desirable in cohort studies, since they minimize the potential for

confounding related to the difference in risk factors between an external reference group and the study population.

Third, the authors should have reported the basic data on which the conclusions are founded, even if sophisticated statistical analyses were employed. At the very least, they should have given the numbers of exposed and unexposed cases and controls in a case–control study and the numbers of cases observed and expected in a cohort study. Further tabulations by time since exposure began and other temporal factors are also important. In a cohort study, data on all cancer sites and all causes of death should have been given, to reveal the possibility of reporting bias. In a case–control study, the effects of investigated factors other than the exposure of interest should have been reported.

Finally, the statistical methods used to obtain estimates of relative risk, absolute rates of cancer, confidence intervals and significance tests, and to adjust for confounding should have been clearly stated by the authors. These methods have been reviewed for case–control studies ([Breslow & Day, 1980](#)) and for cohort studies ([Breslow & Day, 1987](#)).

(c) *Meta-analyses and pooled analyses*

Independent epidemiological studies of the same agent may lead to results that are difficult to interpret. Combined analyses of data from multiple studies are a means of resolving this ambiguity, and well conducted analyses can be considered. There are two types of combined analysis. The first involves combining summary statistics such as relative risks from individual studies (meta-analysis) and the second involves a pooled analysis of the raw data from the individual studies (pooled analysis) ([Greenland, 1998](#)).

The advantages of combined analyses are increased precision due to increased sample size and the opportunity to explore potential confounders, interactions and modifying effects

that may explain heterogeneity among studies in more detail. A disadvantage of combined analyses is the possible lack of compatibility of data from various studies due to differences in subject recruitment, procedures of data collection, methods of measurement and effects of unmeasured co-variates that may differ among studies. Despite these limitations, well conducted combined analyses may provide a firmer basis than individual studies for drawing conclusions about the potential carcinogenicity of agents.

IARC may commission a meta-analysis or pooled analysis that is pertinent to a particular *Monograph* (see Part A, Section 4). Additionally, as a means of gaining insight from the results of multiple individual studies, ad hoc calculations that combine data from different studies may be conducted by the Working Group during the course of a *Monograph* meeting. The results of such original calculations, which would be specified in the text by presentation in square brackets, might involve updates of previously conducted analyses that incorporate the results of more recent studies or de-novo analyses. Irrespective of the source of data for the meta-analyses and pooled analyses, it is important that the same criteria for data quality be applied as those that would be applied to individual studies and to ensure also that sources of heterogeneity between studies be taken into account.

(d) *Temporal effects*

Detailed analyses of both relative and absolute risks in relation to temporal variables, such as age at first exposure, time since first exposure, duration of exposure, cumulative exposure, peak exposure (when appropriate) and time since cessation of exposure, are reviewed and summarized when available. Analyses of temporal relationships may be useful in making causal inferences. In addition, such analyses may suggest whether a carcinogen acts early or late in the process of carcinogenesis, although, at best, they

allow only indirect inferences about mechanisms of carcinogenesis.

(e) *Use of biomarkers in epidemiological studies*

Biomarkers indicate molecular, cellular or other biological changes and are increasingly used in epidemiological studies for various purposes (IARC, 1991; Vainio *et al.*, 1992; Toniolo *et al.*, 1997; Vineis *et al.*, 1999; Buffler *et al.*, 2004). These may include evidence of exposure, of early effects, of cellular, tissue or organism responses, of individual susceptibility or host responses, and inference of a mechanism (see Part B, Section 4b). This is a rapidly evolving field that encompasses developments in genomics, epigenomics and other emerging technologies.

Molecular epidemiological data that identify associations between genetic polymorphisms and interindividual differences in susceptibility to the agent(s) being evaluated may contribute to the identification of carcinogenic hazards to humans. If the polymorphism has been demonstrated experimentally to modify the functional activity of the gene product in a manner that is consistent with increased susceptibility, these data may be useful in making causal inferences. Similarly, molecular epidemiological studies that measure cell functions, enzymes or metabolites that are thought to be the basis of susceptibility may provide evidence that reinforces biological plausibility. It should be noted, however, that when data on genetic susceptibility originate from multiple comparisons that arise from subgroup analyses, this can generate false-positive results and inconsistencies across studies, and such data therefore require careful evaluation. If the known phenotype of a genetic polymorphism can explain the carcinogenic mechanism of the agent being evaluated, data on this phenotype may be useful in making causal inferences.

(f) *Criteria for causality*

After the quality of individual epidemiological studies of cancer has been summarized and assessed, a judgement is made concerning the strength of evidence that the agent in question is carcinogenic to humans. In making its judgement, the Working Group considers several criteria for causality (Hill, 1965). A strong association (e.g. a large relative risk) is more likely to indicate causality than a weak association, although it is recognized that estimates of effect of small magnitude do not imply lack of causality and may be important if the disease or exposure is common. Associations that are replicated in several studies of the same design or that use different epidemiological approaches or under different circumstances of exposure are more likely to represent a causal relationship than isolated observations from single studies. If there are inconsistent results among investigations, possible reasons are sought (such as differences in exposure), and results of studies that are judged to be of high quality are given more weight than those of studies that are judged to be methodologically less sound.

If the risk increases with the exposure, this is considered to be a strong indication of causality, although the absence of a graded response is not necessarily evidence against a causal relationship. The demonstration of a decline in risk after cessation of or reduction in exposure in individuals or in whole populations also supports a causal interpretation of the findings.

Several scenarios may increase confidence in a causal relationship. On the one hand, an agent may be specific in causing tumours at one site or of one morphological type. On the other, carcinogenicity may be evident through the causation of multiple tumour types. Temporality, precision of estimates of effect, biological plausibility and coherence of the overall database are considered. Data on biomarkers may be employed in

an assessment of the biological plausibility of epidemiological observations.

Although rarely available, results from randomized trials that show different rates of cancer among exposed and unexposed individuals provide particularly strong evidence for causality.

When several epidemiological studies show little or no indication of an association between an exposure and cancer, a judgement may be made that, in the aggregate, they show evidence of lack of carcinogenicity. Such a judgement requires first that the studies meet, to a sufficient degree, the standards of design and analysis described above. Specifically, the possibility that bias, confounding or misclassification of exposure or outcome could explain the observed results should be considered and excluded with reasonable certainty. In addition, all studies that are judged to be methodologically sound should (a) be consistent with an estimate of effect of unity for any observed level of exposure, (b) when considered together, provide a pooled estimate of relative risk that is at or near to unity, and (c) have a narrow confidence interval, due to sufficient population size. Moreover, no individual study nor the pooled results of all the studies should show any consistent tendency that the relative risk of cancer increases with increasing level of exposure. It is important to note that evidence of lack of carcinogenicity obtained from several epidemiological studies can apply only to the type(s) of cancer studied, to the dose levels reported, and to the intervals between first exposure and disease onset observed in these studies. Experience with human cancer indicates that the period from first exposure to the development of clinical cancer is sometimes longer than 20 years; latent periods substantially shorter than 30 years cannot provide evidence for lack of carcinogenicity.

3. Studies of cancer in experimental animals

All known human carcinogens that have been studied adequately for carcinogenicity in experimental animals have produced positive results in one or more animal species ([Wilbourn *et al.*, 1986](#); [Tomatis *et al.*, 1989](#)). For several agents (e.g. aflatoxins, diethylstilbestrol, solar radiation, vinyl chloride), carcinogenicity in experimental animals was established or highly suspected before epidemiological studies confirmed their carcinogenicity in humans ([Vainio *et al.*, 1995](#)). Although this association cannot establish that all agents that cause cancer in experimental animals also cause cancer in humans, it is biologically plausible that agents for which there is *sufficient evidence of carcinogenicity* in experimental animals (see Part B, Section 6b) also present a carcinogenic hazard to humans. Accordingly, in the absence of additional scientific information, these agents are considered to pose a carcinogenic hazard to humans. Examples of additional scientific information are data that demonstrate that a given agent causes cancer in animals through a species-specific mechanism that does not operate in humans or data that demonstrate that the mechanism in experimental animals also operates in humans (see Part B, Section 6).

Consideration is given to all available long-term studies of cancer in experimental animals with the agent under review (see Part A, Section 4). In all experimental settings, the nature and extent of impurities or contaminants present in the agent being evaluated are given when available. Animal species, strain (including genetic background where applicable), sex, numbers per group, age at start of treatment, route of exposure, dose levels, duration of exposure, survival and information on tumours (incidence, latency, severity or multiplicity of neoplasms or preneoplastic lesions) are reported. Those studies in experimental animals that are judged to be irrelevant to the evaluation or judged to be inadequate

(e.g. too short a duration, too few animals, poor survival; see below) may be omitted. Guidelines for conducting long-term carcinogenicity experiments have been published (e.g. [OECD, 2002](#)).

Other studies considered may include: experiments in which the agent was administered in the presence of factors that modify carcinogenic effects (e.g. initiation–promotion studies, co-carcinogenicity studies and studies in genetically modified animals); studies in which the end-point was not cancer but a defined precancerous lesion; experiments on the carcinogenicity of known metabolites and derivatives; and studies of cancer in non-laboratory animals (e.g. livestock and companion animals) exposed to the agent.

For studies of mixtures, consideration is given to the possibility that changes in the physicochemical properties of the individual substances may occur during collection, storage, extraction, concentration and delivery. Another consideration is that chemical and toxicological interactions of components in a mixture may alter dose–response relationships. The relevance to human exposure of the test mixture administered in the animal experiment is also assessed. This may involve consideration of the following aspects of the mixture tested: (i) physical and chemical characteristics, (ii) identified constituents that may indicate the presence of a class of substances and (iii) the results of genetic toxicity and related tests.

The relevance of results obtained with an agent that is analogous (e.g. similar in structure or of a similar virus genus) to that being evaluated is also considered. Such results may provide biological and mechanistic information that is relevant to the understanding of the process of carcinogenesis in humans and may strengthen the biological plausibility that the agent being evaluated is carcinogenic to humans (see Part B, Section 2f).

(a) *Qualitative aspects*

An assessment of carcinogenicity involves several considerations of qualitative importance, including (i) the experimental conditions under which the test was performed, including route, schedule and duration of exposure, species, strain (including genetic background where applicable), sex, age and duration of follow-up; (ii) the consistency of the results, for example, across species and target organ(s); (iii) the spectrum of neoplastic response, from preneoplastic lesions and benign tumours to malignant neoplasms; and (iv) the possible role of modifying factors.

Considerations of importance in the interpretation and evaluation of a particular study include: (i) how clearly the agent was defined and, in the case of mixtures, how adequately the sample characterization was reported; (ii) whether the dose was monitored adequately, particularly in inhalation experiments; (iii) whether the doses, duration of treatment and route of exposure were appropriate; (iv) whether the survival of treated animals was similar to that of controls; (v) whether there were adequate numbers of animals per group; (vi) whether both male and female animals were used; (vii) whether animals were allocated randomly to groups; (viii) whether the duration of observation was adequate; and (ix) whether the data were reported and analysed adequately.

When benign tumours (a) occur together with and originate from the same cell type as malignant tumours in an organ or tissue in a particular study and (b) appear to represent a stage in the progression to malignancy, they are usually combined in the assessment of tumour incidence ([Huff *et al.*, 1989](#)). The occurrence of lesions presumed to be preneoplastic may in certain instances aid in assessing the biological plausibility of any neoplastic response observed. If an agent induces only benign neoplasms that appear to be end-points that do not readily undergo

transition to malignancy, the agent should nevertheless be suspected of being carcinogenic and requires further investigation.

(b) Quantitative aspects

The probability that tumours will occur may depend on the species, sex, strain, genetic background and age of the animal, and on the dose, route, timing and duration of the exposure. Evidence of an increased incidence of neoplasms with increasing levels of exposure strengthens the inference of a causal association between the exposure and the development of neoplasms.

The form of the dose–response relationship can vary widely, depending on the particular agent under study and the target organ. Mechanisms such as induction of DNA damage or inhibition of repair, altered cell division and cell death rates and changes in intercellular communication are important determinants of dose–response relationships for some carcinogens. Since many chemicals require metabolic activation before being converted to their reactive intermediates, both metabolic and toxicokinetic aspects are important in determining the dose–response pattern. Saturation of steps such as absorption, activation, inactivation and elimination may produce nonlinearity in the dose–response relationship ([Hoel et al., 1983](#); [Gart et al., 1986](#)), as could saturation of processes such as DNA repair. The dose–response relationship can also be affected by differences in survival among the treatment groups.

(c) Statistical analyses

Factors considered include the adequacy of the information given for each treatment group: (i) number of animals studied and number examined histologically, (ii) number of animals with a given tumour type and (iii) length of survival. The statistical methods used should be clearly stated and should be the generally accepted techniques refined for this purpose ([Peto et al., 1980](#);

[Gart et al., 1986](#); [Portier & Bailer, 1989](#); [Bieler & Williams, 1993](#)). The choice of the most appropriate statistical method requires consideration of whether or not there are differences in survival among the treatment groups; for example, reduced survival because of non-tumour-related mortality can preclude the occurrence of tumours later in life. When detailed information on survival is not available, comparisons of the proportions of tumour-bearing animals among the effective number of animals (alive at the time the first tumour was discovered) can be useful when significant differences in survival occur before tumours appear. The lethality of the tumour also requires consideration: for rapidly fatal tumours, the time of death provides an indication of the time of tumour onset and can be assessed using life-table methods; non-fatal or incidental tumours that do not affect survival can be assessed using methods such as the Mantel-Haenzel test for changes in tumour prevalence. Because tumour lethality is often difficult to determine, methods such as the Poly-K test that do not require such information can also be used. When results are available on the number and size of tumours seen in experimental animals (e.g. papillomas on mouse skin, liver tumours observed through nuclear magnetic resonance tomography), other more complicated statistical procedures may be needed ([Sherman et al., 1994](#); [Dunson et al., 2003](#)).

Formal statistical methods have been developed to incorporate historical control data into the analysis of data from a given experiment. These methods assign an appropriate weight to historical and concurrent controls on the basis of the extent of between-study and within-study variability: less weight is given to historical controls when they show a high degree of variability, and greater weight when they show little variability. It is generally not appropriate to discount a tumour response that is significantly increased compared with concurrent controls by arguing that it falls within the range of historical controls,

particularly when historical controls show high between-study variability and are, thus, of little relevance to the current experiment. In analysing results for uncommon tumours, however, the analysis may be improved by considering historical control data, particularly when between-study variability is low. Historical controls should be selected to resemble the concurrent controls as closely as possible with respect to species, gender and strain, as well as other factors such as basal diet and general laboratory environment, which may affect tumour-response rates in control animals ([Haseman et al., 1984](#); [Fung et al., 1996](#); [Greim et al., 2003](#)).

Although meta-analyses and combined analyses are conducted less frequently for animal experiments than for epidemiological studies due to differences in animal strains, they can be useful aids in interpreting animal data when the experimental protocols are sufficiently similar.

4. Mechanistic and other relevant data

Mechanistic and other relevant data may provide evidence of carcinogenicity and also help in assessing the relevance and importance of findings of cancer in animals and in humans. The nature of the mechanistic and other relevant data depends on the biological activity of the agent being considered. The Working Group considers representative studies to give a concise description of the relevant data and issues that they consider to be important; thus, not every available study is cited. Relevant topics may include toxicokinetics, mechanisms of carcinogenesis, susceptible individuals, populations and life-stages, other relevant data and other adverse effects. When data on biomarkers are informative about the mechanisms of carcinogenesis, they are included in this section.

These topics are not mutually exclusive; thus, the same studies may be discussed in more than

one subsection. For example, a mutation in a gene that codes for an enzyme that metabolizes the agent under study could be discussed in the subsections on toxicokinetics, mechanisms and individual susceptibility if it also exists as an inherited polymorphism.

(a) *Toxicokinetic data*

Toxicokinetics refers to the absorption, distribution, metabolism and elimination of agents in humans, experimental animals and, where relevant, cellular systems. Examples of kinetic factors that may affect dose–response relationships include uptake, deposition, biopersistence and half-life in tissues, protein binding, metabolic activation and detoxification. Studies that indicate the metabolic fate of the agent in humans and in experimental animals are summarized briefly, and comparisons of data from humans and animals are made when possible. Comparative information on the relationship between exposure and the dose that reaches the target site may be important for the extrapolation of hazards between species and in clarifying the role of in-vitro findings.

(b) *Data on mechanisms of carcinogenesis*

To provide focus, the Working Group attempts to identify the possible mechanisms by which the agent may increase the risk of cancer. For each possible mechanism, a representative selection of key data from humans and experimental systems is summarized. Attention is given to gaps in the data and to data that suggests that more than one mechanism may be operating. The relevance of the mechanism to humans is discussed, in particular, when mechanistic data are derived from experimental model systems. Changes in the affected organs, tissues or cells can be divided into three non-exclusive levels as described below.

(i) Changes in physiology

Physiological changes refer to exposure-related modifications to the physiology and/or response of cells, tissues and organs. Examples of potentially adverse physiological changes include mitogenesis, compensatory cell division, escape from apoptosis and/or senescence, presence of inflammation, hyperplasia, metaplasia and/or preneoplasia, angiogenesis, alterations in cellular adhesion, changes in steroidal hormones and changes in immune surveillance.

(ii) Functional changes at the cellular level

Functional changes refer to exposure-related alterations in the signalling pathways used by cells to manage critical processes that are related to increased risk for cancer. Examples of functional changes include modified activities of enzymes involved in the metabolism of xenobiotics, alterations in the expression of key genes that regulate DNA repair, alterations in cyclin-dependent kinases that govern cell cycle progression, changes in the patterns of post-translational modifications of proteins, changes in regulatory factors that alter apoptotic rates, changes in the secretion of factors related to the stimulation of DNA replication and transcription and changes in gap-junction-mediated intercellular communication.

(iii) Changes at the molecular level

Molecular changes refer to exposure-related changes in key cellular structures at the molecular level, including, in particular, genotoxicity. Examples of molecular changes include formation of DNA adducts and DNA strand breaks, mutations in genes, chromosomal aberrations, aneuploidy and changes in DNA methylation patterns. Greater emphasis is given to irreversible effects.

The use of mechanistic data in the identification of a carcinogenic hazard is specific to the mechanism being addressed and is not readily

described for every possible level and mechanism discussed above.

Genotoxicity data are discussed here to illustrate the key issues involved in the evaluation of mechanistic data.

Tests for genetic and related effects are described in view of the relevance of gene mutation and chromosomal aberration/aneuploidy to carcinogenesis ([Vainio et al., 1992](#); [McGregor et al., 1999](#)). The adequacy of the reporting of sample characterization is considered and, when necessary, commented upon; with regard to complex mixtures, such comments are similar to those described for animal carcinogenicity tests. The available data are interpreted critically according to the end-points detected, which may include DNA damage, gene mutation, sister chromatid exchange, micronucleus formation, chromosomal aberrations and aneuploidy. The concentrations employed are given, and mention is made of whether the use of an exogenous metabolic system in vitro affected the test result. These data are listed in tabular form by phylogenetic classification.

Positive results in tests using prokaryotes, lower eukaryotes, insects, plants and cultured mammalian cells suggest that genetic and related effects could occur in mammals. Results from such tests may also give information on the types of genetic effect produced and on the involvement of metabolic activation. Some end-points described are clearly genetic in nature (e.g. gene mutations), while others are associated with genetic effects (e.g. unscheduled DNA synthesis). In-vitro tests for tumour promotion, cell transformation and gap-junction intercellular communication may be sensitive to changes that are not necessarily the result of genetic alterations but that may have specific relevance to the process of carcinogenesis. Critical appraisals of these tests have been published ([Montesano et al., 1986](#); [McGregor et al., 1999](#)).

Genetic or other activity manifest in humans and experimental mammals is regarded to be of

greater relevance than that in other organisms. The demonstration that an agent can induce gene and chromosomal mutations in mammals *in vivo* indicates that it may have carcinogenic activity. Negative results in tests for mutagenicity in selected tissues from animals treated *in vivo* provide less weight, partly because they do not exclude the possibility of an effect in tissues other than those examined. Moreover, negative results in short-term tests with genetic end-points cannot be considered to provide evidence that rules out the carcinogenicity of agents that act through other mechanisms (e.g. receptor-mediated effects, cellular toxicity with regenerative cell division, peroxisome proliferation) ([Vainio *et al.*, 1992](#)). Factors that may give misleading results in short-term tests have been discussed in detail elsewhere ([Montesano *et al.*, 1986](#); [McGregor *et al.*, 1999](#)).

When there is evidence that an agent acts by a specific mechanism that does not involve genotoxicity (e.g. hormonal dysregulation, immune suppression, and formation of calculi and other deposits that cause chronic irritation), that evidence is presented and reviewed critically in the context of rigorous criteria for the operation of that mechanism in carcinogenesis (e.g. [Capen *et al.*, 1999](#)).

For biological agents such as viruses, bacteria and parasites, other data relevant to carcinogenicity may include descriptions of the pathology of infection, integration and expression of viruses, and genetic alterations seen in human tumours. Other observations that might comprise cellular and tissue responses to infection, immune response and the presence of tumour markers are also considered.

For physical agents that are forms of radiation, other data relevant to carcinogenicity may include descriptions of damaging effects at the physiological, cellular and molecular level, as for chemical agents, and descriptions of how these effects occur. 'Physical agents' may also be considered to comprise foreign bodies, such as

surgical implants of various kinds, and poorly soluble fibres, dusts and particles of various sizes, the pathogenic effects of which are a result of their physical presence in tissues or body cavities. Other relevant data for such materials may include characterization of cellular, tissue and physiological reactions to these materials and descriptions of pathological conditions other than neoplasia with which they may be associated.

(c) *Other data relevant to mechanisms*

A description is provided of any structure-activity relationships that may be relevant to an evaluation of the carcinogenicity of an agent, the toxicological implications of the physical and chemical properties, and any other data relevant to the evaluation that are not included elsewhere.

High-output data, such as those derived from gene expression microarrays, and high-throughput data, such as those that result from testing hundreds of agents for a single end-point, pose a unique problem for the use of mechanistic data in the evaluation of a carcinogenic hazard. In the case of high-output data, there is the possibility to overinterpret changes in individual end-points (e.g. changes in expression in one gene) without considering the consistency of that finding in the broader context of the other end-points (e.g. other genes with linked transcriptional control). High-output data can be used in assessing mechanisms, but all end-points measured in a single experiment need to be considered in the proper context. For high-throughput data, where the number of observations far exceeds the number of end-points measured, their utility for identifying common mechanisms across multiple agents is enhanced. These data can be used to identify mechanisms that not only seem plausible, but also have a consistent pattern of carcinogenic response across entire classes of related compounds.

(d) *Susceptibility data*

Individuals, populations and life-stages may have greater or lesser susceptibility to an agent, based on toxicokinetics, mechanisms of carcinogenesis and other factors. Examples of host and genetic factors that affect individual susceptibility include sex, genetic polymorphisms of genes involved in the metabolism of the agent under evaluation, differences in metabolic capacity due to life-stage or the presence of disease, differences in DNA repair capacity, competition for or alteration of metabolic capacity by medications or other chemical exposures, pre-existing hormonal imbalance that is exacerbated by a chemical exposure, a suppressed immune system, periods of higher-than-usual tissue growth or regeneration and genetic polymorphisms that lead to differences in behaviour (e.g. addiction). Such data can substantially increase the strength of the evidence from epidemiological data and enhance the linkage of in-vivo and in-vitro laboratory studies to humans.

(e) *Data on other adverse effects*

Data on acute, subchronic and chronic adverse effects relevant to the cancer evaluation are summarized. Adverse effects that confirm distribution and biological effects at the sites of tumour development, or alterations in physiology that could lead to tumour development, are emphasized. Effects on reproduction, embryonic and fetal survival and development are summarized briefly. The adequacy of epidemiological studies of reproductive outcome and genetic and related effects in humans is judged by the same criteria as those applied to epidemiological studies of cancer, but fewer details are given.

5. Summary

This section is a summary of data presented in the preceding sections. Summaries can be

found on the *Monographs* programme web site (<http://monographs.iarc.fr>).

(a) *Exposure data*

Data are summarized, as appropriate, on the basis of elements such as production, use, occurrence and exposure levels in the workplace and environment and measurements in human tissues and body fluids. Quantitative data and time trends are given to compare exposures in different occupations and environmental settings. Exposure to biological agents is described in terms of transmission, prevalence and persistence of infection.

(b) *Cancer in humans*

Results of epidemiological studies pertinent to an assessment of human carcinogenicity are summarized. When relevant, case reports and correlation studies are also summarized. The target organ(s) or tissue(s) in which an increase in cancer was observed is identified. Dose–response and other quantitative data may be summarized when available.

(c) *Cancer in experimental animals*

Data relevant to an evaluation of carcinogenicity in animals are summarized. For each animal species, study design and route of administration, it is stated whether an increased incidence, reduced latency, or increased severity or multiplicity of neoplasms or preneoplastic lesions were observed, and the tumour sites are indicated. If the agent produced tumours after prenatal exposure or in single-dose experiments, this is also mentioned. Negative findings, inverse relationships, dose–response and other quantitative data are also summarized.

(d) *Mechanistic and other relevant data*

Data relevant to the toxicokinetics (absorption, distribution, metabolism, elimination) and

the possible mechanism(s) of carcinogenesis (e.g. genetic toxicity, epigenetic effects) are summarized. In addition, information on susceptible individuals, populations and life-stages is summarized. This section also reports on other toxic effects, including reproductive and developmental effects, as well as additional relevant data that are considered to be important.

6. Evaluation and rationale

Evaluations of the strength of the evidence for carcinogenicity arising from human and experimental animal data are made, using standard terms. The strength of the mechanistic evidence is also characterized.

It is recognized that the criteria for these evaluations, described below, cannot encompass all of the factors that may be relevant to an evaluation of carcinogenicity. In considering all of the relevant scientific data, the Working Group may assign the agent to a higher or lower category than a strict interpretation of these criteria would indicate.

These categories refer only to the strength of the evidence that an exposure is carcinogenic and not to the extent of its carcinogenic activity (potency). A classification may change as new information becomes available.

An evaluation of the degree of evidence is limited to the materials tested, as defined physically, chemically or biologically. When the agents evaluated are considered by the Working Group to be sufficiently closely related, they may be grouped together for the purpose of a single evaluation of the degree of evidence.

(a) Carcinogenicity in humans

The evidence relevant to carcinogenicity from studies in humans is classified into one of the following categories:

Sufficient evidence of carcinogenicity: The Working Group considers that a causal

relationship has been established between exposure to the agent and human cancer. That is, a positive relationship has been observed between the exposure and cancer in studies in which chance, bias and confounding could be ruled out with reasonable confidence. A statement that there is *sufficient evidence* is followed by a separate sentence that identifies the target organ(s) or tissue(s) where an increased risk of cancer was observed in humans. Identification of a specific target organ or tissue does not preclude the possibility that the agent may cause cancer at other sites.

Limited evidence of carcinogenicity: A positive association has been observed between exposure to the agent and cancer for which a causal interpretation is considered by the Working Group to be credible, but chance, bias or confounding could not be ruled out with reasonable confidence.

Inadequate evidence of carcinogenicity: The available studies are of insufficient quality, consistency or statistical power to permit a conclusion regarding the presence or absence of a causal association between exposure and cancer, or no data on cancer in humans are available.

Evidence suggesting lack of carcinogenicity: There are several adequate studies covering the full range of levels of exposure that humans are known to encounter, which are mutually consistent in not showing a positive association between exposure to the agent and any studied cancer at any observed level of exposure. The results from these studies alone or combined should have narrow confidence intervals with an upper limit close to the null value (e.g. a relative risk of 1.0). Bias and confounding should be ruled out with reasonable confidence, and the studies should have an adequate length of follow-up. A conclusion of *evidence suggesting lack of carcinogenicity* is inevitably limited to the cancer sites, conditions and levels of exposure, and length of observation covered by the available studies. In

addition, the possibility of a very small risk at the levels of exposure studied can never be excluded.

In some instances, the above categories may be used to classify the degree of evidence related to carcinogenicity in specific organs or tissues.

When the available epidemiological studies pertain to a mixture, process, occupation or industry, the Working Group seeks to identify the specific agent considered most likely to be responsible for any excess risk. The evaluation is focused as narrowly as the available data on exposure and other aspects permit.

(b) *Carcinogenicity in experimental animals*

Carcinogenicity in experimental animals can be evaluated using conventional bioassays, bioassays that employ genetically modified animals, and other in-vivo bioassays that focus on one or more of the critical stages of carcinogenesis. In the absence of data from conventional long-term bioassays or from assays with neoplasia as the end-point, consistently positive results in several models that address several stages in the multi-stage process of carcinogenesis should be considered in evaluating the degree of evidence of carcinogenicity in experimental animals.

The evidence relevant to carcinogenicity in experimental animals is classified into one of the following categories:

Sufficient evidence of carcinogenicity: The Working Group considers that a causal relationship has been established between the agent and an increased incidence of malignant neoplasms or of an appropriate combination of benign and malignant neoplasms in (a) two or more species of animals or (b) two or more independent studies in one species carried out at different times or in different laboratories or under different protocols. An increased incidence of tumours in both sexes of a single species in a well conducted study, ideally conducted under Good Laboratory Practices, can also provide *sufficient evidence*.

A single study in one species and sex might be considered to provide *sufficient evidence of carcinogenicity* when malignant neoplasms occur to an unusual degree with regard to incidence, site, type of tumour or age at onset, or when there are strong findings of tumours at multiple sites.

Limited evidence of carcinogenicity: The data suggest a carcinogenic effect but are limited for making a definitive evaluation because, e.g. (a) the evidence of carcinogenicity is restricted to a single experiment; (b) there are unresolved questions regarding the adequacy of the design, conduct or interpretation of the studies; (c) the agent increases the incidence only of benign neoplasms or lesions of uncertain neoplastic potential; or (d) the evidence of carcinogenicity is restricted to studies that demonstrate only promoting activity in a narrow range of tissues or organs.

Inadequate evidence of carcinogenicity: The studies cannot be interpreted as showing either the presence or absence of a carcinogenic effect because of major qualitative or quantitative limitations, or no data on cancer in experimental animals are available.

Evidence suggesting lack of carcinogenicity: Adequate studies involving at least two species are available which show that, within the limits of the tests used, the agent is not carcinogenic. A conclusion of *evidence suggesting lack of carcinogenicity* is inevitably limited to the species, tumour sites, age at exposure, and conditions and levels of exposure studied.

(c) *Mechanistic and other relevant data*

Mechanistic and other evidence judged to be relevant to an evaluation of carcinogenicity and of sufficient importance to affect the overall evaluation is highlighted. This may include data on preneoplastic lesions, tumour pathology, genetic and related effects, structure–activity relationships, metabolism and toxicokinetics,

physicochemical parameters and analogous biological agents.

The strength of the evidence that any carcinogenic effect observed is due to a particular mechanism is evaluated, using terms such as ‘weak’, ‘moderate’ or ‘strong’. The Working Group then assesses whether that particular mechanism is likely to be operative in humans. The strongest indications that a particular mechanism operates in humans derive from data on humans or biological specimens obtained from exposed humans. The data may be considered to be especially relevant if they show that the agent in question has caused changes in exposed humans that are on the causal pathway to carcinogenesis. Such data may, however, never become available, because it is at least conceivable that certain compounds may be kept from human use solely on the basis of evidence of their toxicity and/or carcinogenicity in experimental systems.

The conclusion that a mechanism operates in experimental animals is strengthened by findings of consistent results in different experimental systems, by the demonstration of biological plausibility and by coherence of the overall database. Strong support can be obtained from studies that challenge the hypothesized mechanism experimentally, by demonstrating that the suppression of key mechanistic processes leads to the suppression of tumour development. The Working Group considers whether multiple mechanisms might contribute to tumour development, whether different mechanisms might operate in different dose ranges, whether separate mechanisms might operate in humans and experimental animals and whether a unique mechanism might operate in a susceptible group. The possible contribution of alternative mechanisms must be considered before concluding that tumours observed in experimental animals are not relevant to humans. An uneven level of experimental support for different mechanisms may reflect that disproportionate resources

have been focused on investigating a favoured mechanism.

For complex exposures, including occupational and industrial exposures, the chemical composition and the potential contribution of carcinogens known to be present are considered by the Working Group in its overall evaluation of human carcinogenicity. The Working Group also determines the extent to which the materials tested in experimental systems are related to those to which humans are exposed.

(d) Overall evaluation

Finally, the body of evidence is considered as a whole, to reach an overall evaluation of the carcinogenicity of the agent to humans.

An evaluation may be made for a group of agents that have been evaluated by the Working Group. In addition, when supporting data indicate that other related agents, for which there is no direct evidence of their capacity to induce cancer in humans or in animals, may also be carcinogenic, a statement describing the rationale for this conclusion is added to the evaluation narrative; an additional evaluation may be made for this broader group of agents if the strength of the evidence warrants it.

The agent is described according to the wording of one of the following categories, and the designated group is given. The categorization of an agent is a matter of scientific judgement that reflects the strength of the evidence derived from studies in humans and in experimental animals and from mechanistic and other relevant data.

Group 1: The agent is carcinogenic to humans.

This category is used when there is *sufficient evidence of carcinogenicity* in humans. Exceptionally, an agent may be placed in this category when evidence of carcinogenicity in humans is less than *sufficient* but there is *sufficient evidence of carcinogenicity* in experimental

animals and strong evidence in exposed humans that the agent acts through a relevant mechanism of carcinogenicity.

Group 2.

This category includes agents for which, at one extreme, the degree of evidence of carcinogenicity in humans is almost *sufficient*, as well as those for which, at the other extreme, there are no human data but for which there is evidence of carcinogenicity in experimental animals. Agents are assigned to either Group 2A (*probably carcinogenic to humans*) or Group 2B (*possibly carcinogenic to humans*) on the basis of epidemiological and experimental evidence of carcinogenicity and mechanistic and other relevant data. The terms *probably carcinogenic* and *possibly carcinogenic* have no quantitative significance and are used simply as descriptors of different levels of evidence of human carcinogenicity, with *probably carcinogenic* signifying a higher level of evidence than *possibly carcinogenic*.

Group 2A: The agent is probably carcinogenic to humans.

This category is used when there is *limited evidence of carcinogenicity* in humans and *sufficient evidence of carcinogenicity* in experimental animals. In some cases, an agent may be classified in this category when there is *inadequate evidence of carcinogenicity* in humans and *sufficient evidence of carcinogenicity* in experimental animals and strong evidence that the carcinogenesis is mediated by a mechanism that also operates in humans. Exceptionally, an agent may be classified in this category solely on the basis of *limited evidence of carcinogenicity* in humans. An agent may be assigned to this category if it clearly belongs, based on mechanistic considerations, to a class of agents for which one or more members have been classified in Group 1 or Group 2A.

Group 2B: The agent is possibly carcinogenic to humans.

This category is used for agents for which there is *limited evidence of carcinogenicity* in humans and less than *sufficient evidence of carcinogenicity* in experimental animals. It may also be used when there is *inadequate evidence of carcinogenicity* in humans but there is *sufficient evidence of carcinogenicity* in experimental animals. In some instances, an agent for which there is *inadequate evidence of carcinogenicity* in humans and less than *sufficient evidence of carcinogenicity* in experimental animals together with supporting evidence from mechanistic and other relevant data may be placed in this group. An agent may be classified in this category solely on the basis of strong evidence from mechanistic and other relevant data.

Group 3: The agent is not classifiable as to its carcinogenicity to humans.

This category is used most commonly for agents for which the evidence of carcinogenicity is *inadequate* in humans and *inadequate* or *limited* in experimental animals.

Exceptionally, agents for which the evidence of carcinogenicity is *inadequate* in humans but *sufficient* in experimental animals may be placed in this category when there is strong evidence that the mechanism of carcinogenicity in experimental animals does not operate in humans.

Agents that do not fall into any other group are also placed in this category.

An evaluation in Group 3 is not a determination of non-carcinogenicity or overall safety. It often means that further research is needed, especially when exposures are widespread or the cancer data are consistent with differing interpretations.

Group 4: The agent is probably not carcinogenic to humans.

This category is used for agents for which there is *evidence suggesting lack of carcinogenicity*

in humans and in experimental animals. In some instances, agents for which there is *inadequate evidence of carcinogenicity* in humans but *evidence suggesting lack of carcinogenicity* in experimental animals, consistently and strongly supported by a broad range of mechanistic and other relevant data, may be classified in this group.

(e) Rationale

The reasoning that the Working Group used to reach its evaluation is presented and discussed. This section integrates the major findings from studies of cancer in humans, studies of cancer in experimental animals, and mechanistic and other relevant data. It includes concise statements of the principal line(s) of argument that emerged, the conclusions of the Working Group on the strength of the evidence for each group of studies, citations to indicate which studies were pivotal to these conclusions, and an explanation of the reasoning of the Working Group in weighing data and making evaluations. When there are significant differences of scientific interpretation among Working Group Members, a brief summary of the alternative interpretations is provided, together with their scientific rationale and an indication of the relative degree of support for each alternative.

References

- Bieler GS & Williams RL (1993). Ratio estimates, the delta method, and quantal response tests for increased carcinogenicity. *Biometrics*, 49: 793–801. doi:10.2307/2532200 PMID:8241374
- Breslow NE & Day NE (1980). Statistical methods in cancer research. Volume I - The analysis of case-control studies. *IARC Sci Publ*, 32: 5–338. PMID:7216345
- Breslow NE & Day NE (1987). Statistical methods in cancer research. Volume II—The design and analysis of cohort studies. *IARC Sci Publ*, 82: 1–406. PMID:3329634
- Buffler P, Rice J, Baan R *et al.* (2004). Workshop on Mechanisms of Carcinogenesis: Contributions of Molecular Epidemiology. Lyon, 14–17 November 2001. Workshop report. *IARC Sci Publ*, 157: 1–27. PMID:15055286
- Capen CC, Dybing E, Rice JM, Wilbourn JD (1999). Species Differences in Thyroid, Kidney and Urinary Bladder Carcinogenesis. Proceedings of a consensus conference. Lyon, France, 3–7 November 1997. *IARC Sci Publ*, 147: 1–225.
- Cogliano V, Baan R, Straif K *et al.* (2005). Transparency in IARC Monographs. *Lancet Oncol*, 6: 747. doi:10.1016/S1470-2045(05)70380-6
- Cogliano VJ, Baan RA, Straif K *et al.* (2004). The science and practice of carcinogen identification and evaluation. *Environ Health Perspect*, 112: 1269–1274. doi:10.1289/ehp.6950 PMID:15345338
- Dunson DB, Chen Z, Harry J (2003). A Bayesian approach for joint modeling of cluster size and subunit-specific outcomes. *Biometrics*, 59: 521–530. doi:10.1111/1541-0420.00062 PMID:14601753
- Fung KY, Krewski D, Smythe RT (1996). A comparison of tests for trend with historical controls in carcinogen bioassay. *Can J Stat*, 24: 431–454. doi:10.2307/3315326
- Gart JJ, Krewski D, Lee PN *et al.* (1986). Statistical methods in cancer research. Volume III—The design and analysis of long-term animal experiments. *IARC Sci Publ*, 79: 1–219. PMID:3301661
- Greenland S (1998). Meta-analysis. In: *Modern Epidemiology*. Rothman KJ, Greenland S, editors. Philadelphia: Lippincott Williams & Wilkins, pp. 643–673
- Greim H, Gelbke H-P, Reuter U *et al.* (2003). Evaluation of historical control data in carcinogenicity studies. *Hum Exp Toxicol*, 22: 541–549. doi:10.1191/0960327103ht394oa PMID:14655720
- Haseman JK, Huff J, Boorman GA (1984). Use of historical control data in carcinogenicity studies in rodents. *Toxicol Pathol*, 12: 126–135. doi:10.1177/019262338401200203 PMID:11478313
- Hill AB (1965). The environment and disease: Association or causation? *Proc R Soc Med*, 58: 295–300. PMID:14283879
- Hoel DG, Kaplan NL, Anderson MW (1983). Implication of nonlinear kinetics on risk estimation in carcinogenesis. *Science*, 219: 1032–1037. doi:10.1126/science.6823565 PMID:6823565
- Huff JE, Eustis SL, Haseman JK (1989). Occurrence and relevance of chemically induced benign neoplasms in long-term carcinogenicity studies. *Cancer Metastasis Rev*, 8: 1–22. doi:10.1007/BF00047055 PMID:2667783
- IARC (1977). *IARC Monographs Programme on the Evaluation of the Carcinogenic Risk of Chemicals to Humans*. Preamble (IARC Intern Tech Rep No. 77/002)
- IARC (1978). *Chemicals with Sufficient Evidence of Carcinogenicity in Experimental Animals* – IARC Monographs Volumes 1–17 (IARC Intern Tech Rep No. 78/003)

- IARC (1979). *Criteria to Select Chemicals for IARC Monographs* (IARC Intern Tech Rep No. 79/003)
- IARC (1982). Chemicals, industrial processes and industries associated with cancer in humans (IARC Monographs, Volumes 1 to 29). *IARC Monogr Eval Carcinog Risk Chem Hum Suppl*, 4: 1–292.
- IARC (1983). *Approaches to Classifying Chemical Carcinogens According to Mechanism of Action* (IARC Intern Tech Rep No. 83/001)
- IARC (1987). Overall evaluations of carcinogenicity: an updating of IARC Monographs volumes 1 to 42. *IARC Monogr Eval Carcinog Risks Hum Suppl*, 7: 1–440. PMID:3482203
- IARC (1988). *Report of an IARC Working Group to Review the Approaches and Processes Used to Evaluate the Carcinogenicity of Mixtures and Groups of Chemicals* (IARC Intern Tech Rep No. 88/002)
- IARC (1991). *A Consensus Report of an IARC Monographs Working Group on the Use of Mechanisms of Carcinogenesis in Risk Identification* (IARC Intern Tech Rep No. 91/002)
- IARC (2005). *Report of the Advisory Group to Recommend Updates to the Preamble to the IARC Monographs* (IARC Intern Rep No. 05/001)
- IARC (2006). *Report of the Advisory Group to Review the Amended Preamble to the IARC Monographs* (IARC Intern Rep No. 06/001)
- IARC (2004). Some drinking-water disinfectants and contaminants, including arsenic. *IARC Monogr Eval Carcinog Risks Hum*, 84: 1–477. PMID:15645577
- McGregor DB, Rice JM, Venitt S, editors (1999). The use of short- and medium-term tests for carcinogens and data on genetic effects in carcinogenic hazard evaluation. Consensus report. *IARC Sci Publ*, 146: 1–536.
- Montesano R, Bartsch H, Vainio H *et al.*, editors (1986). Long-term and short-term assays for carcinogenesis—a critical appraisal. *IARC Sci Publ*, 83: 1–564.
- OECD (2002). *Guidance Notes for Analysis and Evaluation of Chronic Toxicity and Carcinogenicity Studies* (Series on Testing and Assessment No. 35), Paris: OECD
- Peto R, Pike MC, Day NE *et al.* (1980). Guidelines for simple, sensitive significance tests for carcinogenic effects in long-term animal experiments. *IARC Monogr Eval Carcinog Risk Chem Hum Suppl*, 2: 311–426. PMID:6935185
- Portier CJ & Bailer AJ (1989). Testing for increased carcinogenicity using a survival-adjusted quantal response test. *Fundam Appl Toxicol*, 12: 731–737. doi:10.1016/0272-0590(89)90004-3 PMID:2744275
- Sherman CD, Portier CJ, Kopp-Schneider A (1994). Multistage models of carcinogenesis: an approximation for the size and number distribution of late-stage clones. *Risk Anal*, 14: 1039–1048. doi:10.1111/j.1539-6924.1994.tb00074.x PMID:7846311
- Stewart BW, Kleihues P, editors (2003). *World Cancer Report*, Lyon: IARC
- Tomatis L, Aitio A, Wilbourn J, Shuker L (1989). Human carcinogens so far identified. *Jpn J Cancer Res*, 80: 795–807. PMID:2513295
- Toniolo P, Boffetta P, Shuker DEG *et al.*, editors (1997). Proceedings of the workshop on application of biomarkers to cancer epidemiology. Lyon, France, 20–23 February 1996. *IARC Sci Publ*, 142: 1–318.
- Vainio H, Magee P, McGregor D, McMichael A, editors (1992). Mechanisms of carcinogenesis in risk identification. IARC Working Group Meeting. Lyon, 11–18 June 1991. *IARC Sci Publ*, 116: 1–608.
- Vainio H, Wilbourn JD, Sasco AJ *et al.* (1995). [Identification of human carcinogenic risks in IARC monographs.] *Bull Cancer*, 82: 339–348. PMID:7626841
- Vineis P, Malats N, Lang M *et al.*, editors (1999). Metabolic Polymorphisms and Susceptibility to Cancer. *IARC Sci Publ*, 148: 1–510. PMID:10493243
- Wilbourn J, Haroun L, Heseltine E *et al.* (1986). Response of experimental animals to human carcinogens: an analysis based upon the IARC Monographs programme. *Carcinogenesis*, 7: 1853–1863. doi:10.1093/carcin/7.11.1853 PMID:3769134

GENERAL REMARKS

This one-hundred-and-second volume of the *IARC Monographs* contains evaluations of the carcinogenic hazard to humans of radiofrequency electromagnetic fields. This is the second volume on non-ionizing radiation, after Volume 80 (Static and Extremely Low-Frequency (ELF) Electric and Magnetic Fields; IARC, 2002), and the fourth and last in a series on physical agents, after Volume 75 (Ionizing Radiation, Part 1: X- and Gamma-radiation, and Neutrons; IARC, 2000) and Volume 78 (Ionizing Radiation, Part 2: Some Internally Deposited Radionuclides; IARC, 2001). Solar radiation and ultraviolet radiation were evaluated in Volume 55 (IARC, 1992). The types of radiation evaluated as human carcinogens (Group 1) were revisited in Volume 100D (IARC, 2012). A summary of the findings in the present volume has appeared in *The Lancet Oncology* (Baan *et al.*, 2011)

The topic of this *Monograph* is the evaluation of the carcinogenicity of radiation in the radiofrequency (RF) range (30 kHz to 300 GHz) of the electromagnetic spectrum. This type of radiation is emitted by devices used in wireless telecommunication, including mobile phones, and by many other sources in occupational and general environmental settings. Exposures are ubiquitous in more developed countries and rapidly increasing in developing countries, in particular with respect to the use of mobile phones. There is rising concern as to whether exposure to RF radiation emitted by a mobile phone affects human health and, specifically, whether mobile-phone use increases the risk of cancer of the brain. The general public, manufacturers, regulatory authorities and public health agencies are seeking evidence on the safety of mobile-phone use. Consequently, there has been intense interest in the development and outcome of this *IARC Monograph*. This interest reflects the high prevalence of exposure (which increasingly extends to children), the vast scope of the telecommunications industry, the findings of some epidemiological studies that suggest an increased risk of cancer, and a high level of media coverage of the topic of mobile phones and cancer.

Although the preparation of this *Monograph* had been scheduled so as to include the results of the large international case-control study INTERPHONE on mobile-phone use (conducted in 2000–2004; published in 2010), it should be emphasized that the evaluations in this volume address the general question of whether RF radiation causes cancer in humans or in experimental animals: it does not specifically or exclusively consider mobile phones, but rather the type of radiation emitted by mobile phones and various other sources. Furthermore, this *Monograph* is focused on the potential for an increased risk of cancer among those exposed to RF radiation, but does not provide a quantitative assessment of any cancer risk, nor does it discuss or evaluate any other potential health effects of RF radiation.

The Working Group recognized that mobile-phone technology has transformed the world, making wireless communication rapidly available, especially in less developed countries, with important

benefits to society. With this, an increasingly large population will be exposed, and for longer and longer periods of time. Undoubtedly, questions will continue to arise about the health risks of mobile-phone use and possibly other emerging sources of exposure to RF radiation. This *Monograph* is a comprehensive review of the currently published evidence that also identifies gaps in the available information. These gaps should be resolved with further research if ongoing concerns about the health risks of mobile-phone use are to be addressed with greater certainty.

The Working Group agreed to consider three categories of human exposure to RF radiation: (a) environmental sources such as mobile-phone base stations, broadcast antennae, smart meters, and medical applications; (b) occupational sources such as high-frequency dielectric and induction heaters, and high-power pulsed radars; and (c) the use of personal devices such as mobile phones, cordless phones, Bluetooth devices, and amateur radios.

The general population receives the highest exposure from transmitters close to the body, including hand-held devices such as mobile phones, which deposit most of the RF energy in the brain. Holding a mobile phone to the ear to make a voice call can result in high specific rates of absorption (SAR) of RF energy in the brain, depending on the design and position of the phone and its antenna in relation to the head, the anatomy of the head, and the quality of the connection with the base-station antenna: the better the connection, which is ensured by a dense network of base stations, the lower the energy output from the phone. In children using mobile phones, the average deposition of RF energy may be two times higher in the brain and up to ten times higher in the bone marrow of the skull than in adult users. The use of hands-free kits lowers exposure of the brain to less than 10% of the exposure from use at the ear, but it may increase exposure to other parts of the body.

Typical environmental exposures to the brain from mobile-phone base stations on rooftops and from television and radio stations are several orders of magnitude lower than those from GSM (Global System for Mobile communications) handsets. The average exposure from DECT (Digital Enhanced Cordless Telecommunications) phones is around five times lower than that measured for GSM phones, and third-generation (3G) phones emit, on average, about 100 times less RF energy than second-generation GSM phones, when signals are strong. Similarly, the average output power of Bluetooth wireless hands-free kits is estimated to be around 100 times lower than that of mobile phones. In occupational settings, exposure to high-power sources may involve higher cumulative deposition of RF energy in the body than with exposure to mobile phones, but the energy deposited locally in the brain is generally less.

Epidemiological evidence of an association between RF radiation and cancer comes from time-trend, cohort, and case-control studies. The populations in these studies were exposed to RF radiation in occupational settings, from sources in the general environment, and from use of wireless (mobile and cordless) phones. Two sets of data from case-control studies were considered by the Working Group as the principal and most informative basis for their evaluation of the human evidence, i.e. the INTERPHONE study and the Swedish case-control studies; both sets of data focused on brain tumours among mobile-phone users.

The Working Group recognized not only the rapid increase worldwide in the use of wireless communication systems – both in number of users and in duration of use – but also the considerable technological developments in this area, with the introduction of third- and fourth-generation (3G and 4G) devices during the past decade. It is of interest to note that the key epidemiological studies mentioned above were conducted in the late 1990s and the early 2000s. In the INTERPHONE study, all participating countries in Europe had GSM networks. It is worth mentioning that the 3G and 4G

mobile phones commercially available today – equipped with adaptive power control – emit considerably less RF energy than the GSM phones used more than a decade ago.

Experimental evidence from cancer bioassays was evaluated by the Working Group after reviewing more than 40 studies that assessed the incidence of tumours in rodents exposed to RF radiation at various frequencies, some of which simulated emissions from mobile phones. In the evaluation of studies of cancer in experimental animals, exposure assessment deserves critical consideration. In this regard, the conduct of cancer bioassays with RF radiation presents challenges that are not ordinarily encountered in studies with chemical or other physical agents. For example, the radiation frequency is an important determinant of the specific absorption rate (SAR). The whole-body SAR provides little information about spatial or organ-specific energy deposition, as it strongly depends on field polarization and animal posture. Furthermore, long-term exposure to RF radiation at a fixed frequency and power density will result in substantial changes in SAR over time as an animal gains body weight. Even if the power is adjusted for body weight changes, the spatial distribution can vary. Full dosimetric analyses of all these variables are only available in a few studies. Furthermore, SARs to which animals can be exposed without the induction of systemic toxicity are generally limited by the induction of thermal effects; increases in body temperature may induce biological responses that are not seen at the (generally much lower) levels of RF radiation to which humans may be exposed. In a substantial number of studies, exposure was at SAR values below the maximum tolerated dose (MTD); nonetheless, these studies were considered to provide useful data, and were included in the evaluation.

Several cancer bioassays with RF radiation were conducted with exposure systems in which animals were restrained (usually in tubes) or non-restrained (in cages) during exposure. In this *Monograph*, study designs involving animal restraint were identified as such. Exposures involving animal restraint are generally limited to periods of no more than 4 hours per day. They have the advantage of optimal exposure uniformity and maximal local delivery of RF-radiation energy to the head or other selected body parts. Exposure of animals in cages – whole-body exposure – can be for up to 24 hours per day. The design of some bioassays with restrained animals included both sham-exposed and cage-control animals; because of the possibly confounding effects of restraint stress, the Working Group compared tumour responses in the exposed groups only to the responses in sham-exposed controls. Lack of a sham-exposed control group was considered a serious flaw in the study design.

The Working Group reviewed a large number of studies with end-points relevant to mechanisms of carcinogenesis, including genotoxicity, effects on immune function, gene and protein expression, cell signalling, oxidative stress, and apoptosis. Studies on the possible effects of RF radiation on the blood–brain barrier, and on a variety of effects in the brain itself were also considered. The Working Group found several studies inadequately controlled for the thermal effects of RF radiation, but also noted well conducted studies showing aneuploidy, spindle disturbances, altered microtubule structures or induction of DNA damage. While RF radiation has insufficient energy to directly produce genetic damage, other changes such as induction of oxidative stress and production of reactive oxygen species may explain these results. Indeed, several studies *in vitro* evaluated the possible role of RF radiation in altering levels of intracellular oxidants or activities of antioxidant enzymes. While the overall evidence was inconclusive, the Working Group expressed concern about the results from several of these studies.

References

- Baan R, Grosse Y, Lauby-Secretan B *et al.* WHO International Agency for Research on Cancer Monograph Working Group (2011). Carcinogenicity of radiofrequency electromagnetic fields. *Lancet Oncol*, 12: 624–626. doi:10.1016/S1470-2045(11)70147-4 PMID:21845765
- IARC (1992). IARC Monographs on the evaluation of carcinogenic risks to humans. Solar and ultraviolet radiation. *IARC Monogr Eval Carcinog Risks Hum*, 55: 1–316. PMID:1345607
- IARC (2000). Ionizing radiation, Part 1: X- and gamma- radiation and neutrons. *IARC Monogr Eval Carcinog Risks Hum*, 75: 1–492. PMID:11203346
- IARC (2001). Ionizing radiation, Part 2: some internally deposited radionuclides. *IARC Monogr Eval Carcinog Risks Hum*, 78: 1–559. PMID:11421248
- IARC (2002). Non-ionizing radiation, Part 1: static and extremely low-frequency (ELF) electric and magnetic fields. *IARC Monogr Eval Carcinog Risks Hum*, 80: 1–395. PMID:12071196
- IARC (2012). Radiation. *IARC Monogr Eval Carcinog Risks Hum*, 100D: 1–437. PMID:23189752

1. EXPOSURE DATA

1.1 Introduction

This chapter explains the physical principles and terminology relating to sources, exposures and dosimetry for human exposures to radiofrequency electromagnetic fields (RF-EMF). It also identifies critical aspects for consideration in the interpretation of biological and epidemiological studies.

1.1.1 *Electromagnetic radiation*

Radiation is the process through which energy travels (or “propagates”) in the form of waves or particles through space or some other medium. The term “electromagnetic radiation” specifically refers to the wave-like mode of transport in which energy is carried by electric (E) and magnetic (H) fields that vary in planes perpendicular to each other and to the direction of energy propagation.

The variations in electric and magnetic field strength depend only on the source of the waves, and most man-made sources of electromagnetic radiation produce waves with field strengths that vary sinusoidally with time, as shown in Fig. 1.1. The number of cycles per second is known as the frequency (f) and is quantified in the unit hertz (Hz). The waves travel at the speed of light (c) in free space and in air, but more slowly in dielectric media, including body tissues. The wavelength (λ) is the distance between successive peaks in

a wave (Fig. 1.1) and is related to the frequency according to $\lambda = c/f$ ([ICNIRP, 2009a](#)).

The fundamental equations of electromagnetism, Maxwell’s equations, imply that a time-varying electric field generates a time-varying magnetic field and vice versa. These varying fields are thus described as “interdependent” and together they form a propagating electromagnetic wave. The ratio of the strength of the electric-field component to that of the magnetic-field component is constant in an electromagnetic wave and is known as the characteristic impedance of the medium (η) through which the wave propagates. The characteristic impedance of free space and air is equal to 377 ohm ([ICNIRP, 2009a](#)).

It should be noted that the perfect sinusoidal case shown in Fig. 1.1, in which a wave has a sharply defined frequency, is somewhat ideal; man-made waves are usually characterized by noise-like changes in frequency over time that result in the energy they carry being spread over a range of frequencies. Waves from some sources may show purely random variation over time and no evident sinusoidal character. Some field waveforms, particularly with industrial sources, can have a distorted shape while remaining periodic, and this corresponds to the presence of harmonic components at multiples of the fundamental frequency ([ICNIRP, 2009a](#)).

The quantities and units used to characterize electromagnetic radiation are listed in [Table 1.1](#).

Fig. 1.1 A sinusoidally varying electromagnetic wave viewed in time at a point in space (a) and in space at a point in time (b)

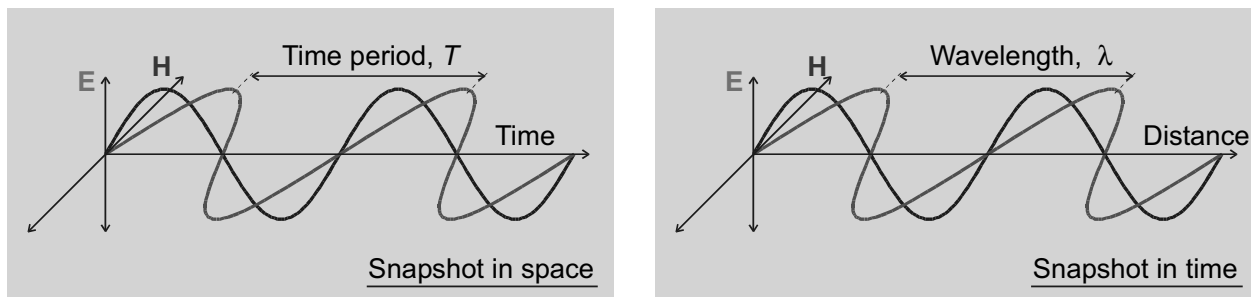

(a)

(b)

E, electric field; H, magnetic field.
Prepared by the Working Group

1.1.2 The electromagnetic spectrum

The frequency of electromagnetic radiation determines the way in which it interacts with matter; a variety of different terms are used to refer to radiation with different physical properties. The electromagnetic spectrum, describing the range of all possible frequencies of electromagnetic radiation, is shown in Fig. 1.2.

For the purposes of this *Monograph*, radio-frequency (RF) electromagnetic radiation will be taken as extending from 30 kHz to 300 GHz, which corresponds to free-space wavelengths in the range of 10 km to 1 mm. Electromagnetic fields (EMF) in the RF range can be used readily for communication purposes as radio waves. As shown in Fig. 1.2, the International Telecommunications Union (ITU) has developed a categorization for radio waves according to their frequency decade: very low frequency (VLF); voice frequency (VF); low frequency (LF); medium frequency (MF); high frequency (HF); very high frequency (VHF); ultra-high frequency (UHF); super-high frequency (SHF); and extremely high frequency (EHF) (ITU, 2008).

Radio waves with frequencies in the range 300 MHz to 300 GHz can be referred to as microwaves, although this does not imply any sudden change in physical properties at 300 MHz. The

photon energy would be about 1 μeV (micro-electronvolt) at 300 MHz.

Above the frequencies used by radio waves are the infrared, visible ultraviolet (UV), X-ray and gamma-ray portions of the spectrum. At RF and up to around the UV region, it is conventional to refer to the radiation wavelength, rather than frequency. Photon energy is generally referred to in the X-ray and gamma-ray regions, and also to some extent in the UV range, because the particle-like properties of the EMFs become more obvious in these spectral regions.

Below the RF portion of the spectrum lie EMFs that are used for applications other than radiocommunication. The interdependence of the electric- and magnetic-field components also becomes less strong and they tend to be considered entirely separately at the frequency (50 Hz) associated with distribution of electricity (IARC, 2002).

1.1.3 Exposures to EMF

RF fields within the 30 kHz to 300 GHz region of the spectrum considered in this *Monograph* arise from a variety of sources, which are considered in Section 1.2. The strongest fields to which people are exposed arise from the intentional use of the physical properties of fields, such as

Table 1.1 Quantities and units used in the radiofrequency band

Quantity	Symbol	Unit	Symbol
Conductivity	σ	siemens per metre	S/m
Current	I	ampere	A
Current density	J	ampere per square metre	A/m ²
Electric-field strength	E	volt per metre	V/m
Frequency	f	hertz	Hz
Impedance	Z or η	ohm	Ω
Magnetic-field strength	H	ampere per metre	A/m
Permittivity	ϵ	farad per metre	F/m
Power density	S or Pd	watt per square metre	W/m ²
Propagation constant	K	per metre	m ⁻¹
Specific absorption	SA	joule per kilogram	J/kg
Specific absorption rate	SAR	watt per kilogram	W/kg
Wavelength	λ	metre	m

Adapted from [ICNIRP \(2009a\)](#)

induction heating (including the industrial heating of materials and cooking hobs), remote detection of objects and devices (anti-theft devices, radar, radiofrequency identification [RFID]), telecommunications (radio, television, mobile phones, wireless networks), medical diagnostics and therapy (magnetic resonance imaging [MRI], hyperthermia), and many more. There are also unintentionally generated fields, such as those associated with the electrical ballasts used for fluorescent lighting, electronic circuits, processors and motors.

When considering human exposures it is important to recognize that, in addition to the EMFs associated with energy being radiated away from a source, there are electric and magnetic fields associated with energy stored in the vicinity of the source, and this energy is not propagating. The reactive fields associated with this stored energy are stronger than the radiated fields within the region known as the reactive near field, which extends to a distance of about a wavelength from the source. The wave impedance in the reactive near field may be higher than the impedance of free space if a source is capacitive in nature and lower if a source is inductive in nature ([AGNIR, 2003](#)).

Beyond the near field region lies the far field, where the RF fields have the characteristics of radiation, i.e. with planar wave fronts and E and H components that are perpendicular to each other and to the direction of propagation. The power density of the radiation, P_d , describes the energy flux per unit area in the plane of the fields expressed as watts per square metre (W/m²) and decreases with distance squared (the inverse square law). Power density can be determined from the field strengths (see Glossary) ([AGNIR, 2003](#)).

Sources that are large relative to the wavelength of the RF fields they produce, e.g. dish antennae, also have a region known as the radiating near field that exists in between the reactive near field and the far field. In this region the wave impedance is equal to 377 ohm, but the wave fronts do not have planar characteristics: there is an oscillatory variation in power density with distance and the angular distribution of the radiation also changes with distance. Since the radiating near field is taken to extend to a distance of $2D^2/\lambda$ (where D is the largest dimension of the antenna) from the source, it is therefore necessary to be located beyond both this distance and

Fig. 1.2 The electromagnetic spectrum

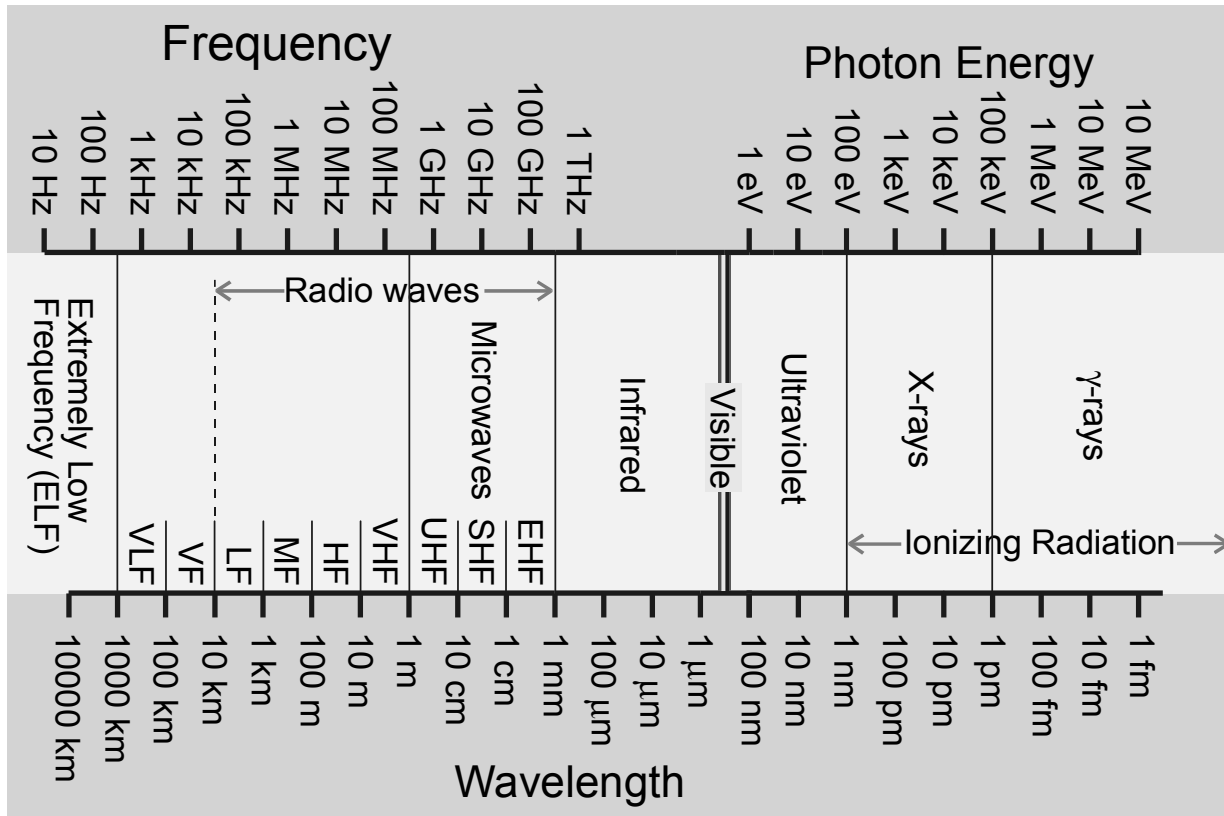

The figure shows frequency increasing from left to right expressed in hertz (Hz) and in kHz (kilo-), MHz (mega-), GHz (giga-) and THz (tera-) (denoting multipliers of 10^3 , 10^6 , 10^9 and 10^{12}). Electromagnetic fields in the radiofrequency (RF) range can be used for communication purposes as radio waves. Mobile phones operate in the low-microwave range, around 1 GHz. The terms VLF, VF, LF, MF, HF, VHF, UHF, SHF, EHF denote very low frequency, voice frequency, low frequency, medium frequency, high frequency, very high frequency, ultra-high frequency, super-high frequency, and extremely high frequency, respectively.

Beyond the frequencies used by radio waves follow the infrared, visible, ultraviolet, X-ray and gamma-ray portions of the spectrum. Above radiofrequencies and up to around the ultraviolet region, it is conventional to refer to the wavelength (expressed in metres and its multipliers) of the radiation, rather than frequency. Below the radiofrequency portion of the spectrum lie electromagnetic fields that are used for applications other than radiocommunications. Photon energy is expressed in electronvolts (eV and its multipliers).

Prepared by the Working Group

about a wavelength from a source to be in the far-field region ([AGNIR, 2003](#)).

The incident EMFs (external fields when the body is not present) interact or couple with the human body and induce EMFs and currents within the body tissues. A different interaction mechanism exists for the electric- and magnetic-field components, as discussed in detail in Section 1.3. In general, both quantities must be determined to fully characterize human exposure, unless the exposure is to pure radiating fields. The coupling depends on the size of the wavelength relative to

the dimensions of the human body and, therefore, dosimetric interactions are often considered in three different frequency ranges: 30 kHz to 10 MHz (body larger than the wavelength), 10 MHz to 10 GHz (body dimensions comparable to the wavelength), and 10 GHz to 300 GHz (body dimensions much larger than the wavelength).

1.2 Sources of exposure

This section describes natural and man-made sources of RF fields to which people are exposed during their everyday lives at home, work and elsewhere in the environment. Fields from natural and man-made sources differ in their spectral and time-domain characteristics and this complicates comparisons of their relative strengths. The fields produced by natural sources have a much broader frequency spectrum than those produced by man-made sources and it is necessary to define a bandwidth of interest for comparison. In a bandwidth of 1 MHz, man-made fields will typically appear to be orders of magnitude stronger than natural ones, whereas if the entire bandwidth of 300 GHz of interest to this *Monograph* is chosen, natural fields may appear to be stronger than man-made ones at typical environmental levels ([ICNIRP, 2009a](#)).

When considering sources, it is helpful to clearly delineate the concepts of emissions, exposures and dose:

Emissions from a source are characterized by the radiated power, including its spectral and time-domain distributions: the polarization and the angular distribution (pattern) of the radiation. For sources that are large relative to their distance from a location where a person is exposed, it also becomes necessary to consider the spatial distribution of the emitted radiation over the entire structure of the source to fully describe it as an emitter.

Exposure describes the EMFs from the source at a location where a person may be present in terms of the strength and direction of the electric and magnetic fields. If these vary over the volume occupied by a person (non-uniform exposure), possibly because the source is close to them, or has strongly directional characteristics, it becomes necessary to quantify the RF fields over the space occupied by the person. The exposure depends not only on the source emissions and the geometrical relationship to the

source (distance, angular direction), but also on the effect of the environment on the radiated fields. This can involve processes such as reflection, shielding, and diffraction, all of which can modify the fields substantially.

Dose is concerned with quantities of effects inside the body tissues that are induced by the exposure fields. These include the electric- or magnetic-field strength in the body tissues and the specific energy absorption rate (SAR) (see Section 1.3.2, and Glossary). The strength of the electric fields within the body tissues is generally much smaller than that of the exposure fields outside the body, and depends on the electrical parameters of the tissues ([Beiser, 1995](#)).

In most situations, the concept of emissions leading to exposure and then dose is helpful, but there are situations in which the presence of an exposed individual and the dose received affect the emissions from a source. This means that the intermediate concept of exposure cannot be isolated meaningfully, and dose has to be assessed directly from the source emissions either through computational modelling or via measurement of fields inside the body tissues. When the way in which a source radiates is strongly affected by the presence of an exposed person, the source and the exposed person are described as “mutually coupled”; a classic example of this is when a mobile phone is used next to the body.

1.2.1 Natural fields

The natural electromagnetic environment originates from the Earth (terrestrial sources) and from space (extraterrestrial sources) (Fig. 1.3). Compared with man-made fields, natural fields are extremely small at RFs ([ICNIRP, 2009a](#)).

The energy of natural fields tends to be spread over a very wide range of frequencies. Many natural sources emit RF radiation and optical radiation according to Planck’s law of “black-body radiation” (see Fig. 1.4; [Beiser, 1995](#)).

Fig. 1.3 Terrestrial and extraterrestrial sources of radiofrequency radiation

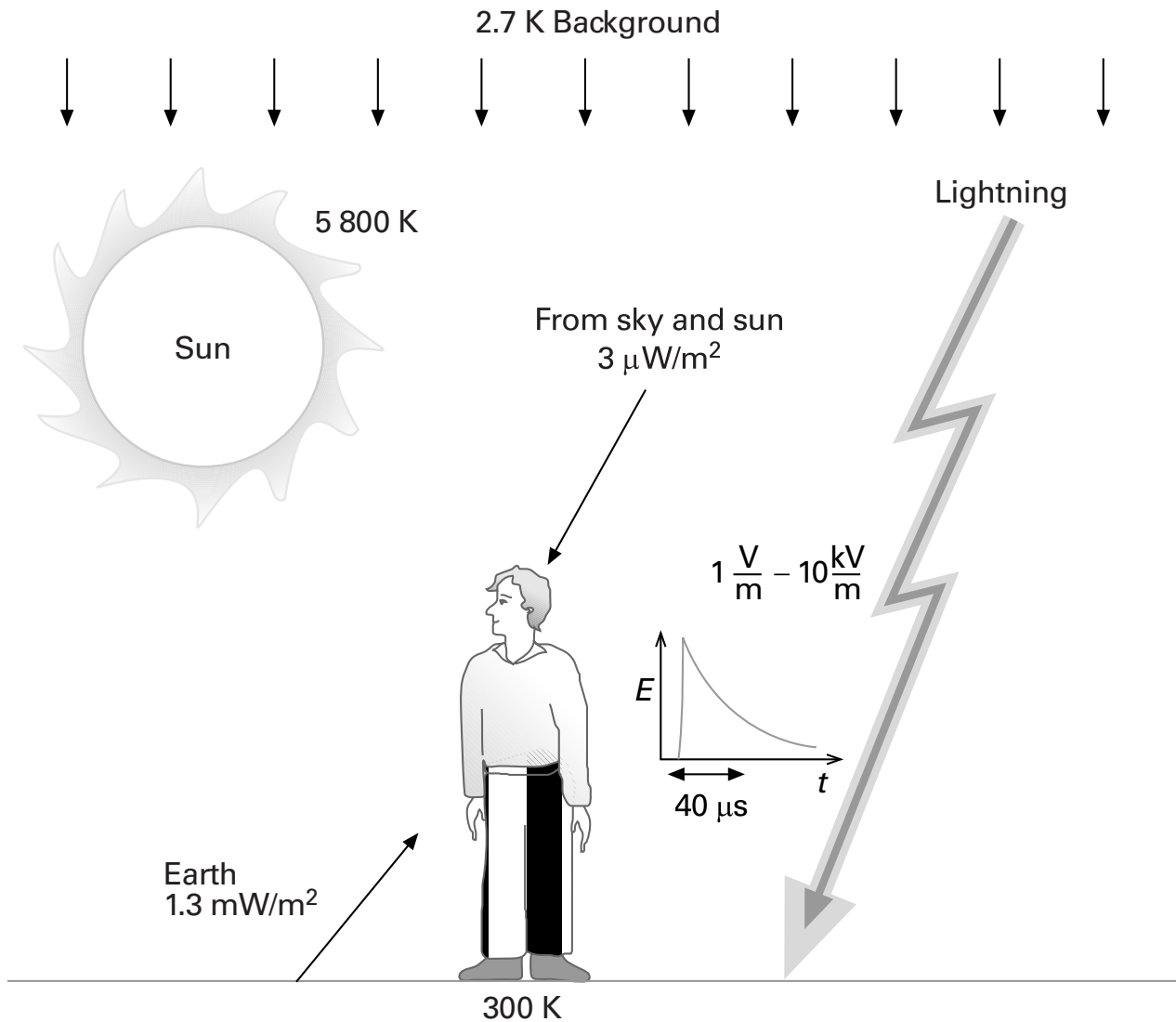

E, electric field strength; K, Kelvin; kV, kilovolt; m, metre; μs, microsecond; t, time; V, volt; W/m², watt per square metre.
 The solar radiation spectrum is similar to that of a black body with a temperature of about 5800 °K. The sun emits radiation across most of the electromagnetic spectrum, i.e. X-rays, ultraviolet radiation, visible light, infrared radiation, and radio waves. The total amount of energy received by the Earth at ground level from the sun at the zenith is approximately 1000 W/m², which is composed of approximately 53% infrared, 44% visible light, 3% ultraviolet, and a tiny fraction of radio waves (3 μW/m²).
 From [ICNIRP \(2009a\)](http://www.icnirp.de) <http://www.icnirp.de>

Fig. 1.4 Equations used in calculating energy and emitted power of black-body radiators

$$S(f,T) = \frac{2hf^2}{c^2} \frac{1}{\frac{hf}{e^{kT}} - 1} \quad J^* = \sigma T^4$$

(a) Planck's Law of "black body radiation"

$S(f,T)$ is the power radiated per unit area of emitting surface in the normal direction per unit solid angle per unit frequency by a black body at temperature T .

h is the Planck constant, equal to 6.626×10^{-34} Js.

c is the speed of light in a vacuum, equal to 2.998×10^8 m/s.

k is the Boltzmann constant, equal to 1.381×10^{-23} J/K.

f is the frequency of the electromagnetic radiation in hertz (Hz).

T is the temperature of the body in Kelvin (K).

(b) Stefan-Boltzmann Law

J^* , the black-body irradiance or emissive power, is directly proportional to the fourth power of the black-body thermodynamic temperature T (also called absolute temperature).

σ , the constant of proportionality, called Stefan-Boltzmann constant.

The total power emitted per unit surface area of a black-body radiator can be evaluated by integrating Planck's law over all angles in a half-space (2π steradians) and over all frequencies. This yields the Stefan-Boltzmann law (see Fig. 1.4), which describes how the power emitted by a black-body radiator increases with the fourth power of the absolute temperature ([Beiser, 1995](#)).

(a) Extraterrestrial sources

Extraterrestrial sources include electrical discharges in the Earth's atmosphere, and solar and cosmic radiation. Heat remaining from the "big bang" at the formation of the universe is evident as the cosmic microwave background (CMB), which presents as black-body radiation from all directions towards the Earth. The observed peak in the CMB spectrum is at a frequency of 160.2 GHz, which according to Planck's law (see Fig. 1.4) implies a temperature of 2.725 K ([Fixsen, 2009](#)). Fig 1.5 shows the results of evaluating Planck's law over the frequency range 30 kHz to 300 GHz. The total power density in this frequency range represents 80% of the total power density across all frequencies. Applying this factor to the results from Stefan-Boltzmann's

law at 2.725 K gives the power density at the surface of the Earth as $2.5 \mu\text{W}/\text{m}^2$.

The sun is also a black-body radiator and its spectrum shows a peak at 3.4×10^{14} Hz, a wavelength of 880 nm, commensurate with a surface temperature of 5778 K ([NASA, 2011](#)). Based on Planck's law, most of the sun's radiation is in the infrared region of the spectrum. Only a small proportion is in the frequency range 30 kHz to 300 GHz; this fraction represents about $5 \mu\text{W}/\text{m}^2$ of the total power density of $1366 \text{ W}/\text{m}^2$ incident on the Earth. This value is similar to that from the CMB, which contributes power from all directions, but the RF power from the sun is predominantly incident from the direction of the sun, and hence much reduced at night ([ICNIRP, 2009a](#)).

The atmosphere of the Earth has a marked effect on RF fields arriving from space. The ionosphere, which extends from about 60 km to 600 km above the Earth's surface, contains layers of charged particles and reflects RF fields at frequencies of up to about 30 MHz. Above a few tens of gigahertz, atmospheric water vapour and oxygen have an attenuating effect on RF fields, due to absorption. These effects mean that the RF power density incident at the Earth's surface

Fig. 1.5 Power density spectrum of the cosmic microwave background in the radiofrequency range (30 kHz to 300 GHz)

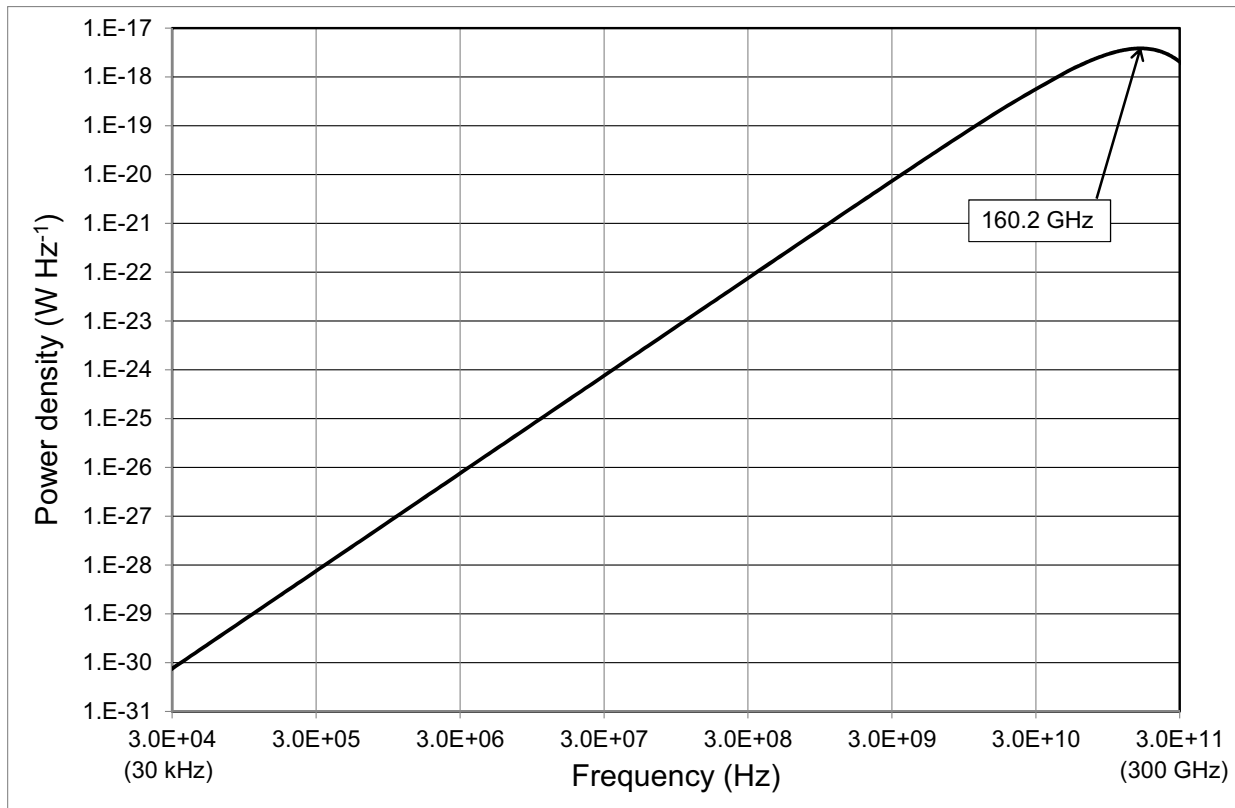

Prepared by the Working Group

from the sun and the CMB will be somewhat less than the $5 \mu\text{W}/\text{m}^2$ values given for each above. The International Commission on Non-Ionizing Radiation Protection (ICNIRP) gives the total power density arising from the sky and the sun as $3 \mu\text{W}/\text{m}^2$ at the surface of the Earth (see Fig. 1.3; [ICNIRP, 2009a](#)).

(b) Terrestrial sources

The Earth itself is a black-body radiator with a typical surface temperature of about 300 K (see Fig. 1.3). Most emissions from Earth are in the infrared part of the spectrum and only 0.0006% of the emitted power is in the RF region, which amounts to a few milliwatts per square metre from the Earth's surface. This is about a thousand times larger than the RF power density arising from the sky and the sun ([ICNIRP, 2009a](#)).

People also produce black-body radiation from their body surfaces (skin). Assuming a surface temperature of 37°C , i.e. 310 K, the power density for a person would be $2.5 \text{ mW}/\text{m}^2$ in the RF range. With a typical skin area of 1.8 m^2 , the total radiated power from a person is about 4.5 mW.

As mentioned above, the ionosphere effectively shields the Earth from extraterrestrially arising RF fields at frequencies below 30 MHz. However, lightning is an effective terrestrial source of RF fields below 30 MHz. The fields are generated impulsively as a result of the time-varying voltages and currents associated with lightning, and the waveguide formed between the surface of the Earth and the ionosphere enables the RF fields generated to propagate over large distances around the Earth.

On average, lightning strikes the Earth 40 times per second, or 10 times per square kilometre per year. Maps of annual flash rates based on observations by National Aeronautics and Space Administration (NASA) satellites can be consulted on the National Oceanic and Atmospheric Administration (NOAA) web site ([NOAA, 2011](#)). The EMFs from lightning are impulsive and vary depending on the nature of each stroke and also according to the distance at which they are measured. A typical pulse-amplitude of 4 V/m at 200 km corresponds to a peak power density of 42 mW/m², and a total pulse energy density of 2.5 mJ/m² ([ICNIRP, 2009a](#)). [Cooray \(2003\)](#) has described various mathematical models for return strokes, which are the strongest sources of RF-EMF associated with lightning. Peak electric-field strengths of up to 10 kV/m are possible within 1 km from where the lightning strikes. At distances greater than 100 km, the field strength decreases rapidly to a few volts per metre, with peak dE/dt of about 20 V/m per μ s, and then further decreases over a few tens of microseconds. [Willett et al. \(1990\)](#) measured the electric-field strength during return strokes as a function of time and conducted Fourier analysis to determine the average spectrum between 200 kHz and 30 MHz. The energy spectral density reduced according to $1/f^2$ at frequencies of up to about 10 MHz and more rapidly thereafter.

1.2.2 Man-made fields

There are numerous different sources of man-made RF fields. The more common and notable man-made sources of radiation in the RF range of 30 kHz to 300 GHz are presented in Fig. 1.6.

Sometimes such fields are an unavoidable consequence of the way systems operate, e.g. in the case of broadcasting and telecommunications, where the receiving equipment is used at locations where people are present. In other situations, the fields are associated with energy

waste from a process, e.g. in the case of systems designed to heat materials ([ICNIRP, 2009a](#)).

The typical emission characteristics of sources will be summarized here, along with exposure and dose information where available. However, it is important to recognize that fields typically vary greatly in the vicinity of sources and spot measurements reported in the literature may not be typical values. This is because assessments are often designed to identify the maximum exposures that can be reasonably foreseen, e.g. for workers near sources, and to ensure that these do not exceed exposure limits.

(a) Radio and television broadcasting

The frequency bands used for broadcasting of radio and television signals are broadly similar across countries and are shown in [Table 1.2](#).

Analogue broadcast radio has been available for many years and uses amplitude modulation (AM) in the long, medium and short-wave bands, but the sound quality is not as good as with frequency modulation (FM) in band II, which became available later and is now more popular for listening. The short-wave band continues to be important for international radio broadcasting, because signals in this frequency band can be reflected from the ionosphere to travel around the world and reach countries thousands of kilometres away ([AGNIR, 2003](#)).

Band III was the original band used for television broadcasting and continues to be used for this purpose in some countries, while others have transferred their television services to bands IV and V. Band III is also used for digital audio broadcasting (DAB), exclusively so in countries that have transferred all their television services to bands IV and V. Analogue and digital television transmissions presently share bands III, IV and V, but many countries are in the process of transferring entirely to digital broadcasting ([ICNIRP, 2009a](#)).

[AGNIR \(2003\)](#) have described broadcasting equipment in the United Kingdom in terms of

Fig. 1.6 Man-made sources of radiation in the radiofrequency range (30 kHz to 300 GHz)

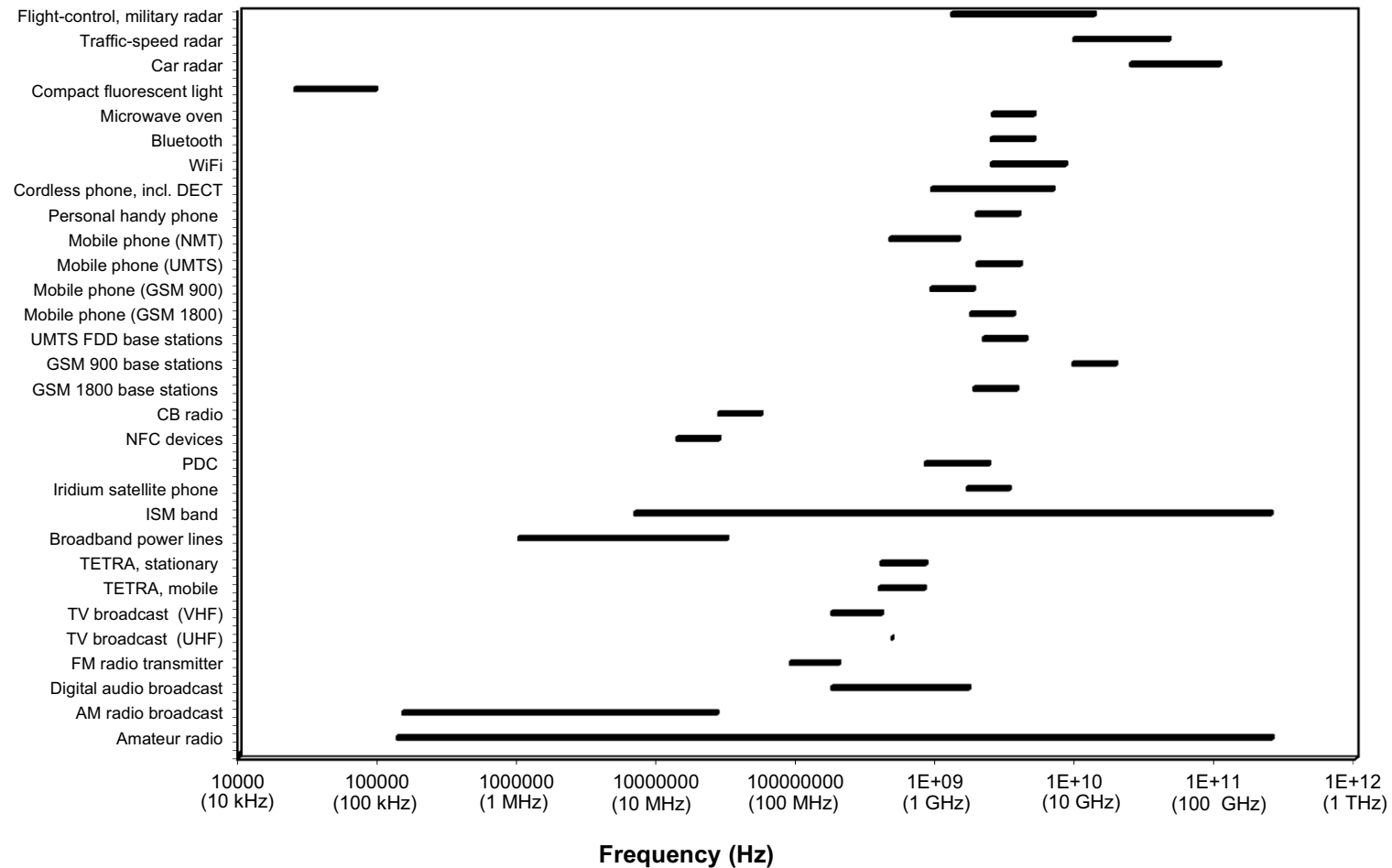

AM, amplitude-modulated; CB, citizen band; DECT, digital enhanced cordless telecommunications; FDD, frequency-division duplex; FM, frequency-modulated; GSM, Global System for Mobile communications; ISM, industrial, scientific and medical; NFC, near-field communication; PDC, personal digital cellular; TETRA, Terrestrial Trunked Radio; TV, television; UHF, ultra-high frequency; UMTS, Universal Mobile Telecommunications System; VHF, very high frequency; WiFi, standard wireless local area network (WLAN) technology.

Prepared by the Working Group

Table 1.2 Frequency bands used for broadcasting of television and radio signals

Designation	Frequency range	Usage
Long wave	145.5 – 283.5 kHz	AM radio
Medium wave	526.5 – 1606.5 kHz	AM radio
Short wave	3.9 – 26.1 MHz	International radio
UHF (Bands IV and V)	470 – 854 MHz	Analogue and digital TV
VHF (Band II)	87.5 – 108 MHz	FM radio
VHF (Band III)	174 – 223 MHz	DAB and analogue/digital TV

AM, amplitude modulation; DAB, digital audio broadcasting; FM, frequency modulation; TV, television; UHF, ultra high frequency; VHF, very high frequency

Adapted from [AGNIR \(2003\)](#)

the numbers of transmitters operating at a given power level in each frequency band ([Table 1.3](#)). The overall trends are probably similar in other countries and the main change since that time is likely to have been a growth in the number of digital transmitters for radio and television ([ICNIRP, 2009a](#)).

(i) *Long-, medium- and short-wave bands*

Antennae broadcasting in the long- and medium-wave bands tend to be constructed as tall metal towers, with cables linking the towers to each other and to the ground. Often, a single low-frequency (LF) or medium-frequency (MF) radiating structure may involve several closely located towers that are fed in such a way that a directional beam pattern is formed. Some towers are energized and insulated from the ground, while others are grounded and act as reflectors. Transmitters designed to provide local radio services, e.g. around cities, use powers in the range of 100 W to 10 kW, while a small number of transmitters that provide national services over large distances radiate up to a few hundred kilowatts ([ICNIRP, 2009a](#)).

The high-frequency (HF) band is used for international broadcasting and comprises wavelengths that are somewhat shorter than those in the long- and medium-wave bands. Curtain arrays, composed of multiple horizontal dipole antennae suspended between towers, are used to form narrow beams directed upwards towards

the required azimuth and elevation angles. The beams reflect off the ionosphere and provide services to distant countries without the need for any intermediate infrastructure. Typical curtain arrays can be up to 60 m in height and width, and might, for example, involve 16 dipoles arranged as four vertically stacked rows of four with a reflecting wire mesh screen suspended behind them. Given the transmission distances required, the powers are high, typically around 100–500 kW. The HF band has the fewest transmitters of any of the broadcast bands ([ICNIRP, 2009a](#)). [Allen et al. \(1994\)](#) reported 25 HF transmitters with powers in the range 100–500 kW and three with powers greater than 500 kW in the United Kingdom.

Broadcast sites can be quite extensive, with multiple antennae contained within an enclosed area of several square kilometres. A building containing the transmitters is generally located on the site and RF feeder cables are laid from this building to the antennae. On HF sites, switching matrices allow different transmitters to be connected to different antennae according to the broadcast schedule. The feeders may be either enclosed in coaxial arrangements or open, e.g. as twin lines having pairs of conductors around 15 cm apart suspended about 4 m above ground level.

In considering reported measurements of RF fields at MF/HF broadcast sites, it is important to note that workers may spend much of their time

Table 1.3 Approximate number of broadcast transmitters in the United Kingdom^a

Service class	Effective radiated power (kW)					
	0–0.1	> 0.1–1.0	> 1.0–10	> 10–100	> 100–500	> 500
Analogue TV	3496	589	282	122	86	19
DAB	4	126	121	–	–	–
Digital TV	134	177	192	2	–	–
MW/LW radio	14	125	38	19	12	–
VHF FM radio	632	294	232	98	72	–

^a For TV sites, each analogue channel (e.g. BBC1) or each digital multiplex counts as one transmitter.

DAB, digital audio broadcasting; FM, frequency modulation; LW, long wave; MW, medium wave; TV, television; VHF, very high frequency
Adapted from [AGNIR \(2003\)](#)

in offices, workshops or the transmitter halls. Such locations can be far from the antennae, resulting in exposure levels that are much lower than when personnel approach the antennae to carry out maintenance and installation work.

[Jokela et al. \(1994\)](#) investigated the relationship between induced RF currents flowing through the feet to ground and the RF-field strengths from MF and HF broadcast antennae. The MF antenna was a base-fed monopole, 185 m high, transmitting 600 kW at 963 MHz. At distances of 10, 20, 50, and 100 m from the antenna, the electric-field strength at 1 m height was around 420, 200, 60 and 30 V/m, respectively. At the same distances, currents in the feet were around 130, 65, 30 and 10 mA. The HF antenna was a 4 × 4 curtain array suspended between 60 m towers and radiating 500 kW at 21.55 MHz. The total field in front of the antenna at 1 m height ranged from about 32 V/m at 10 m through a maximum of 90 V/m at 30 m, a minimum of 7 V/m at 70 m and thereafter rose to around 20 V/m at distances in the range 100–160 m.

[Mantiply et al. \(1997\)](#) have summarized measurements of RF fields from MF broadcast transmitters contained in several technical reports from the mid-1980s to early 1990s from government agencies in the USA. A study based on spot measurements made at selected outdoor locations in 15 cities and linked to population statistics showed that 3% of the urban population

were exposed to electric-field strengths greater than 1 V/m, while 98% were exposed to field strengths above 70 mV/m and the median exposure was 280 mV/m. RF-field strengths were also measured near eight MF broadcast antennae, one operating at 50 kW, three at 5 kW and four at 1 kW. The measurements were made as a function of distance along three radials at most of the sites. At distances of 1–2 m, the electric-field strengths were in the range 95–720 V/m and the magnetic-field strengths were in the range 0.1–1.5 A/m, while at 100 m, electric-field strengths were 2.5–20 V/m and magnetic-field strengths were in the range 7.7–76 mA/m.

[Mantiply et al. \(1997\)](#) also reported field measurements near short-wave (HF) broadcast antennae. As mentioned earlier, these are designed to direct the beams upwards at low elevation angles. Hence, the field strengths at locations on the ground are determined by sidelobes (see Glossary) from the antennae and they vary unpredictably with distance and from one antenna to another. Measurements were made at four frequencies in the HF band and at six locations in a community around 10 km from an HF site, which was likely to have transmitted 250 kW power. Electric- and magnetic-field strengths at individual frequencies varied in the ranges 1.5–64 mV/m and 0.0055–0.16 mA/m, while the maximum field strengths just outside the site boundary were 8.6 V/m and 29 mA/m.

Field strengths measured at a distance of 100 m along a “traverse” tangential to the beam from a curtain array transmitting at 100 kW were in the ranges 4.2–9.2 V/m and 18–72 mA/m. A final set of measurements was made at a distance of 300 m from another curtain array transmitting at 100 kW, while the beam was steered through $\pm 25^\circ$ in azimuth. The field strengths were in the ranges 1.7–6.9 V/m and 14–29 mA/m.

(ii) *VHF and UHF bands*

The powers used for broadcasting in the VHF and UHF bands vary widely according to the area and terrain over which coverage is to be provided (Table 1.2). UHF transmissions are easily affected by terrain conditions, and shadowed areas with poor signal strength can occur, e.g. behind hills and in valleys. For this reason, in addition to a main set of high-power transmitters, large numbers of local booster transmitters are needed that receive signals from the main transmitters and rebroadcast them into shadowed areas. The main transmitters are mounted at the top of masts that are up to several hundreds of metres high and have effective radiated powers (ERPs) (see Glossary) of up to about 1 MW, while the booster transmitters have antennae that are mounted much nearer to the ground and mostly have powers of less than 100 W. VHF signals are less affected by terrain conditions and fewer booster transmitters are needed.

Typical high-power broadcast transmitter masts are shown in Fig. 1.7.

Access to the antennae on high-power VHF/UHF masts is gained by climbing a ladder inside the tower; reaching the antennae at the top involves passing in close proximity to radiating antennae at lower heights. The VHF transmissions have wavelengths of similar dimensions to the structures that form the tower itself, e.g. the lengths of the steel bars or the spaces between them, and hence tend to excite RF current flows in these items. Standing waves (see Glossary) can be present within the tower, and the measured

field strengths can be strongly affected by the presence of a person taking measurements. Thus, measurements of field strength can seem unstable and difficult to interpret. Currents flowing within the body can be measured at the wrist or ankle and these are more directly related to the specific absorption rate (SAR; dose) in the body than the fields associated with the standing waves. Hence, it can be preferable to measure body current (see Section 1.3) rather than field strength on towers with powerful VHF antennae.

Several papers discussed by [ICNIRP \(2009a\)](#) have reported measurement results in the range of tens to hundreds of volts per metre within broadcast towers, but it is not clear how representative these spot measurements are of typical worker exposures. [Cooper et al. \(2004\)](#) have used an instrument worn on the body as personal dosimeter to measure electric- and magnetic-field strengths during work activities at a transmitter site. They reported that a wide temporal variation in field strengths was typically found within any single record of exposure to electric or magnetic fields during work on a mast or tower used for high-power VHF/UHF broadcasts. Fig 1.8 shows a typical trace that was recorded for a worker during activities near the VHF antennae while climbing on a high-power VHF/UHF lattice mast. The field strength commonly ranged from below the detection threshold of about 14 V/m to a level approaching or exceeding the upper detection limit of about 77 V/m. The highest instantaneous exposures usually occurred when the subject was in the vicinity of high-power VHF antennae or when a portable VHF walkie-talkie radio was used to communicate with other workers.

Field strengths around the foot of towers/masts have also been reported and seem quite variable. [Mantiply et al. \(1997\)](#) described values in the range of 1–30 V/m for VHF television, 1–20 V/m for UHF television and 2–200 V/m for VHF FM radio sites. Certain designs of antennae have relatively strong downward-directed sidelobes,

Fig. 1.7 Typical antenna masts for power broadcasting of radio and television signals**(a)****(b)**

(a) A concrete tower, 368 m high, with a spherical structure at just above 200 m. This is accessed by lifts from ground level and contains various equipment as well as a public restaurant. The radiating antennae are above the sphere and the antennae operating at the highest frequencies are nearest to the top. Multiple dipole antennae protrude through the wall of the red/white cylinder to provide FM radio services in band II, and television and DAB services in band III. Contained within the top-most section of the tower are the band IV and V antennae for more television services.

(b) A steel-lattice tower with the television antennae in the white cylinder at the top. Antennae for VHF and DAB broadcast radio services are mounted on the outside of the tower just below the television antenna and there are multiple antennae for other communications purposes at lower heights. The transmitters are in a building near the base of the tower and the coaxial cables carrying the RF to the transmitting antennae pass up inside the tower.

Courtesy of the Health Protection Agency, United Kingdom

known as grating lobes, which is a possible explanation for such variability.

VHF/UHF broadcast antennae are designed to direct their beams towards the horizon, usually in all directions around the tower. Hence, field strengths at ground level and in communities near the tower are much lower than at comparable distances within the beam. When the beams do eventually reach ground level, they have spread out considerably, again implying that exposures for the general public are substantially lower than

those for workers at locations to which they have access, as summarized above ([ICNIRP, 2009a](#)).

[Mantiply et al. \(1997\)](#) report studies of population exposure in the USA conducted during the 1980s and based on spot measurements at selected outdoor locations. An estimated 50%, 32% and 20% of the population were exposed at greater than 0.1 V/m from VHF radio, VHF television and UHF television signals, respectively. VHF radio and television caused exposures to 0.5% and 0.005% of the population at greater than

Fig. 1.8 Relative electric-field strength recorded for an engineer operating on a mast supporting antennae for high-power VHF/UHF broadcast transmissions

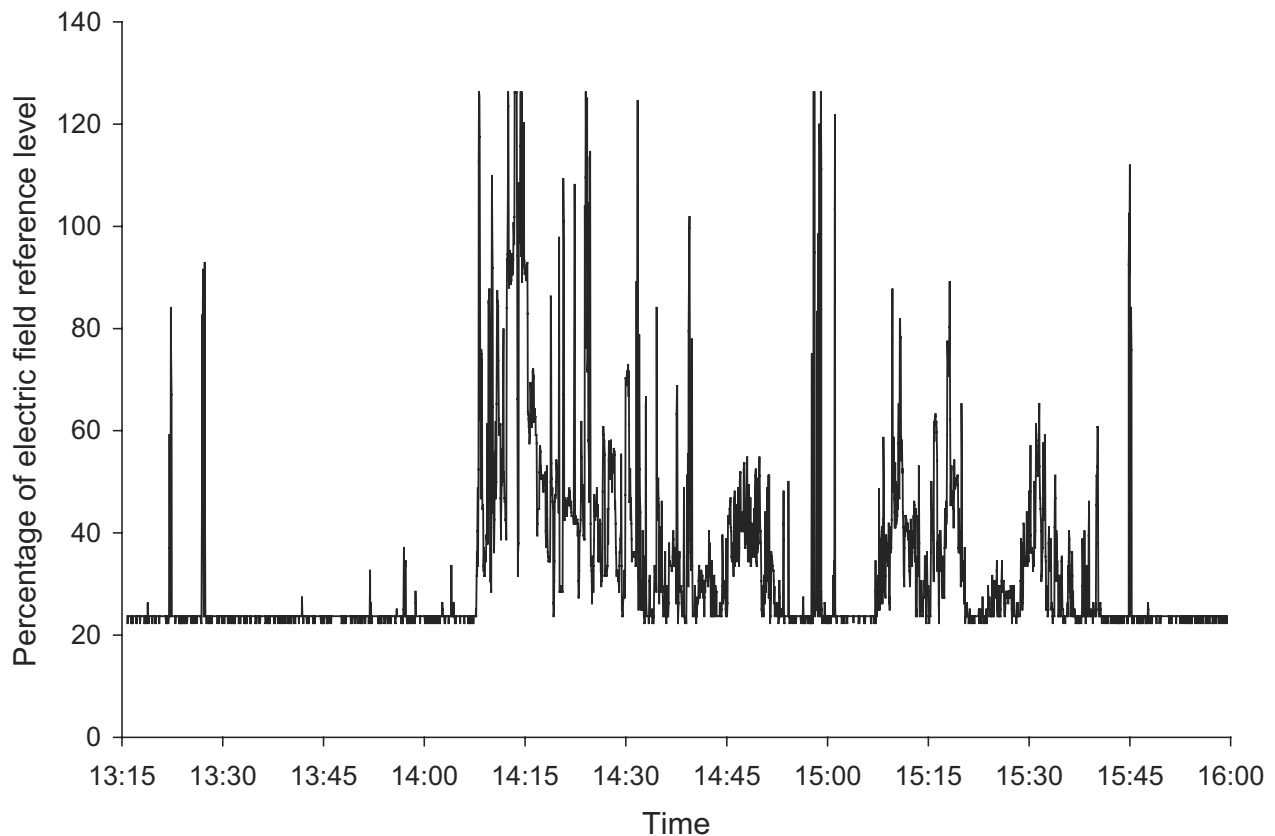

The reference level is 61 V/m, as taken from the [ICNIRP \(1998\)](#) exposure guidelines for workers over the relevant frequency range (10–400 MHz). UHF, ultra high frequency; VHF, very high frequency. From [Cooper et al. \(2004\)](#). By permission of Oxford University Press.

2 V/m, while UHF television caused exposure to 0.01% of the population at greater than 1 V/m.

Field strengths associated with VHF/UHF radio and television broadcast signals were measured at 200 statistically distributed locations in residential areas around Munich and Nuremberg in Germany ([Schubert et al., 2007](#)). The aim of the study was to investigate whether the levels had changed as a result of the switch-over from analogue to digital broadcasting, and measurements were made before and after this change occurred at each location. The median power density was $0.3 \mu\text{W}/\text{m}^2$ (11 mV/m) for the analogue signals and $1.9 \mu\text{W}/\text{m}^2$ (27 mV/m) for the digital signals. FM radio signals had median

power densities of $0.3 \mu\text{W}/\text{m}^2$ (11 mV/m), similar to the analogue television signals, and the values ranged over approximately two orders of magnitude on either side of the medians for all types of broadcast signal. It is interesting to note that these values seem to be lower than those reported in the USA during the 1980s.

(b) Cellular (mobile-phone) networks

Unlike broadcasting, for which high-power transmitters are used to cover large areas extending 100 km or more from the transmitter, cellular networks employ large numbers of low-power transmitters, known as base stations, which are scattered throughout an area where coverage

Fig. 1.9 Example of a coverage plan for a cellular network

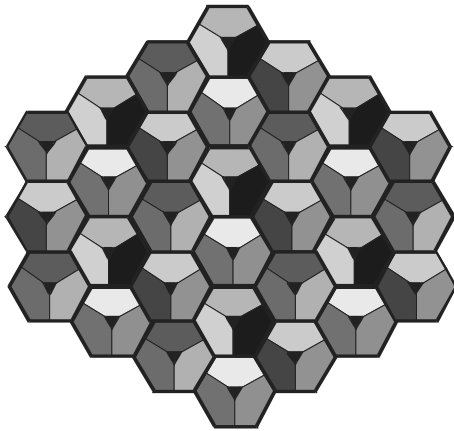

Each cell is hexagonal, with a base station at its centre and configured to provide signals over three sectors of 120 degrees. The shading show how coverage is provided everywhere by use of 12 frequency channels, none of which are used in the adjacent cells.

Courtesy of the Health Protection Agency, United Kingdom

is to be provided. This is because communications are two-way (duplex) in cellular networks, with each user requiring their own dedicated communication channels, both for the uplink (phone to base station) and for the downlink (base station to the phone). Each base station has limited capacity in terms of the number of calls it can serve simultaneously, so the transmitters are closer together in locations where there is a high density of users. For example, the transmitters may be about 10 km apart in sparsely populated areas, but 100 m or less apart in city centres.

An important consideration in the design of cellular networks is that operators have a limited spectrum window available and have to reuse their frequency channels to provide coverage everywhere. A typical frequency map illustrating how coverage can be provided with 12 frequency channels is shown in Fig. 1.9. Signals that use the same frequency in different cells can potentially interfere with each other, but the signal strength diminishes with increasing distance from base stations and frequencies are not reused in adjacent cells/sectors. Hence, services can be provided without interference, provided that

the radiated powers of phones and base stations are minimized during calls. This principle has important consequences for the RF exposures of people using phones and living near base stations ([ICNIRP, 2009a](#)).

Developments in mobile-phone technology are broadly categorized according to four different generations ([Table 1.4](#)). The first-generation networks (1G) were rolled-out in the mid-1980s and included Advanced Mobile Phone System (AMPS) in North America, Total Access Communication Systems (TACS) in much of Europe, Nippon Telegraph and Telephone (NTT) in Japan, and Nordic Mobile Telephony (NMT) in Scandinavia. The systems were based on analogue technology and used frequency modulation to deliver voice-communication services. These networks mostly closed down from around the year 2000, as users moved to later generations of the technology ([ICNIRP, 2009a](#)).

Second-generation networks (2G) were established in the early 1990s and continue to operate. They are based on digital technology and use voice coding to improve spectral efficiency. Many systems use time-division multiple access (TDMA) within their frequency channels and such systems include Global System for Mobile (GSM) in Europe, Personal Digital Cellular (PDC) in Japan, and both Personal Communication Systems (PCS) and D-AMPS (digital AMPS, also known as “TDMA”) in North America. Other north-American systems are known as CDMA, because they use code-division multiple access. 2G systems were extended to include some basic data services, but subsequent systems with enhanced data services were usually termed 2.5G ([ICNIRP, 2009a](#)).

The third generation of mobile phones (3G), with comprehensive data services, became available in the early 2000s. These phones have developed to become today’s “smartphones,” although it is important to recognize that they are fully backward-compatible with 2G networks and whether 2G or 3G is used at any given time

Table 1.4 Frequency bands originally used by different mobile-phone systems

Generation	Start date of commercial availability ^a	Main geographical region	System ^b	Handset band (MHz)	Base-station band (MHz)	Channel spacing (kHz)
1	1981	Nordic countries	NMT450	453.5 – 457.5	463.5 – 467.5	25
	1986		NMT900	890 – 915	935 – 960	12.5
	1985	Europe	TACS/ETACS	872 – 915	917 – 960	25
	1989	Japan	JTACS/NTACS	898 – 925	860 – 870	25/12.5
	1985	Germany	NET-C	451.3 – 455.74	461.3 – 465.74	20
	1985	USA & Canada	AMPS	824 – 849	869 – 894	30
	1985		N-AMPS	824 – 849	869 – 894	10
	1987	Japan	NTT	925 – 940	870 – 885	25
	1992	USA & Canada	TDMA800	824 – 849	869 – 894	30
	1998		TDMA1900	1850 – 1910	1930 – 1990	30
2	1992	Europe	GSM900	890 – 915	935 – 960	200
	1993		GSM1800	1710 – 1785	1805 – 1880	200
	2001	USA & Canada	GSM1900 (PCS)	1850 – 1910	1930 – 1990	200
	1993	Japan	PDC800	940 – 956	810 – 826	25
	1994		PDC1500	1429 – 1465	1477 – 1513	25
	1998	USA & Canada	CDMA800	824 – 849	869 – 894	1250
	1997		CDMA1900	1850 – 1910	1930 – 1990	1250
	3	2001	World	IMT-2000 (W-CDMA)	1920 – 1980 ^c	2110 – 2170 ^c
4		World	LTE	Many possible	Many possible	Various

^a The start dates of use will be different depending on country.

^b For abbreviations, see [Cardis et al. \(2011b\)](#) and [Singal \(2010\)](#).

^c Technical standards for a 2001 version for the 3G systems (IMT-2000). Note that standards for the 3G systems evolve quickly. Compiled by the Working Group and adapted mainly from the references mentioned in footnote b

depends on network coverage and how operators have chosen to manage call/data traffic within their network. The systems use CDMA radio-access methods ([ICNIRP, 2009a](#)).

A fourth generation (4G) of the technology is just starting to be rolled out to meet the increasing demand for data services. Some systems are known as Long-term Evolution (LTE) and use orthogonal frequency-division multiplexing (OFDM), while others are based on Worldwide Interoperability for Microwave Access (WiMax). As with 3G services, this technology will be overlaid on other services, and phones will be able to support multiple access modes (4G, 3G and 2G) ([Buddhikot et al., 2009](#)).

The frequency bands originally used by cellular networks in various parts of the world

are shown in [Table 1.4](#). It is important to note that spectrum liberalization is ongoing at present, such that operators who hold a license for a particular part of the spectrum may choose to use it to provide services with any technology they wish. For example, bands originally reserved for 2G services such as GSM are being made available for 3G/4G services in many countries as demand shifts from 2G to systems with more capacity for data services. Also, with the move to digital-television broadcasting, the spectrum in the frequency range of 698 to 854 MHz is becoming available and being reallocated to 3G/4G cellular services ([Buddhikot et al., 2009](#)).

(i) Mobile-phone handsets

The output powers and – where TDMA is used – the burst characteristics of various types of mobile phones are summarized in [Table 1.5](#). Analogue mobile phones were specified to have maximum equivalent isotropically radiated powers (EIRP) of 1 W, but the antennae were not isotropic and would have had gains of around 2 dB. This implies the radiated powers would have been around 600 mW. 2G mobile phones that use TDMA have time-averaged powers that are less than their peak powers according to their duty factors, i.e. the time they spend transmitting, as a proportion of the total. For example, GSM phones that transmit at a power level of 2 W in the 900 MHz band (GSM900) have time-averaged powers that are 12% of this, i.e. 240 mW. Maximum time-averaged output powers are generally in the range of 125–250 mW for 2G onwards.

Mobile phones are generally held with their transmitting antennae around 1–2 cm from the body, so the RF fields they produce are highly non-uniform over the body and diminish rapidly in strength with increasing distance. The fields penetrate body tissues, leading to energy absorption, which is described by the SAR. SAR values are derived by phone manufacturers under a series of prescribed tests and the maximum value recorded under any of the tests is reported in the product literature. Values in normal usage positions should be lower than the values declared by manufacturers because the positions used in the testing standards are designed to mimic near-worst-case conditions.

While [Table 1.5](#) gives maximum output powers for phones, the actual power used at any point during a call is variable up to this maximum. As mentioned above, to minimize interference in the networks, the power is dynamically reduced to the minimum necessary to carry out calls. [Vrijheid et al. \(2009a\)](#) found that the reduction was on average to around 50% of the maximum

with GSM phones, whereas [Gati et al. \(2009\)](#) reported that 3G phones only operated at a few percent of the maximum power.

Another consideration is that GSM phones employ a mode called discontinuous transmission (DTX), under which their transmission-burst pattern changes to one with a lower duty factor during the periods of a conversation when the mobile-phone user is not talking. [Wiar et al. \(2000\)](#) found that DTX reduced average power by about 30% for GSM phones.

(ii) Time trends in SAR for mobile phones

As shown in [Table 1.5](#), analogue mobile phones had higher specified maximum radiated powers than digital ones (typically 0.6 W versus 0.1–0.25 W). While these systems are no longer in use and few data on exposure are available, it is of interest to consider whether exposures from these phones would have been higher than with present-day phones. Key differences, aside from relative power levels, are that analogue phones were larger than their modern digital counterparts and that they generally had larger antennae, e.g. extractable whip antennae rather than the compact helices and patch antennae used nowadays. The increased distance between the antenna and the head would have reduced the SAR level overall, and the larger size of the antenna would have led to a more diffuse distribution of SAR in the head.

The evolution of localized SAR values over time is also interesting to consider. [Cardis et al. \(2011b\)](#) assembled a database of reported peak 1-g and 10-g SARs for phones from a range of publications and web sites. Most data covered the years 1997–2003, and no significant upward or downward trends over this time period were found for the 900 MHz or 1800 MHz bands.

In summary, the peak spatial SARs (psSAR) do not seem to have changed significantly over time as analogue phones have been replaced by digital ones. However, the more diffuse nature of the distributions produced by analogue phones

Table 1.5 Output powers and TDMA characteristics of various types of mobile phone

System	Peak power (W)		Burst duration (ms)	TDMA duty factor	Average power (W)
	EIRP	Output			
GSM900	-	2.0	0.5769	0.12	0.24
GSM1800	-	1.0	0.5769	0.12	0.12
PCS1900	-	1.0	0.5769	0.12	0.12
NMT450	1.5	0.9	-	NA	0.9
PDC	-	0.8	3.333 or 6.666	1/6 or 1/3	0.133 or 0.266
NMT900	1.0	0.6	-	NA	0.6
TACS/ETACS	1.0	0.6	-	NA	0.6
AMPS/NAMPS	1.0	0.6	-	NA	0.6
TDMA800	-	0.6	6.666	1/3	0.2
TDMA1900	-	0.6	6.666	1/3	0.2
CDMA800	-	0.25	-	NA	0.25
CDMA1900	-	0.25	-	NA	0.25
IMT-2000	-	0.25	-	NA	0.25

EIRP, equivalent isotropically radiated power; NA, not applicable; TDMA, time-division multiple access
Compiled by the Working Group

would likely have led to a greater overall SAR in the head, including the brain.

(iii) Phones not making calls

The emitted powers from phones when they are on standby and not making calls are also of interest. Systematic studies have not been published on this topic, but transmissions under these conditions are brief and infrequent, and exposure is expected to be very small when averaged over time.

Phones equipped for data services such as e-mail will transmit for longer time periods than ordinary phones because they will be checking e-mail servers and synchronizing databases held on the phone with those on remote servers. Also, uploading large files such as videos and photographs may take many minutes. The phone is unlikely to be held against the user's head while this is taking place, although it may be in the user's pocket or elsewhere on the body, which may lead to local emissions at a higher power level than during calls, e.g. if general packet radio service (GPRS) is used, involving multislots transmission with GSM.

The sending of a text message from a mobile phone involves a short period of transmission. [Gati et al. \(2009\)](#) showed that a long text message would take at most 1.5 seconds to send with GSM systems.

(iv) Hands-free kits and Bluetooth earpieces

A phone may sometimes be used with a wired hands-free kit, in which case parts of the body other than the head may be exposed to maximal localized SARs, e.g. if the phone is placed in the user's pocket during the call. While one might expect that the audio cable to the ear-piece would not efficiently guide RF fields to the ear-piece, and that the use of wired hands-free kits would lead to greatly reduced SARs in the head due to the increased distance of the phone from the head, there have been suggestions that this is not always the case.

[Porter et al. \(2005\)](#) showed that the layout of the cables of the hands-free kit was a critical factor in determining head exposures and that certain geometries could result in appreciably more power being coupled into the audio cable than others. However, in all of the combinations

tested, the maximum value for SAR 10 g was lower when a hands-free kit was used than when it was not. [Kühn et al. \(2009a\)](#) further developed procedures for the testing of hands-free kits under worst-case and realistic conditions of use and applied them to a set of phones and kits. The authors concluded that exposure of the entire head was lower when a hands-free kit was used than when the phone was held directly against the head, but that there might be very localized increases in exposure in the ear.

Wireless hands-free kits are available that use the Bluetooth RF communications protocol to link to a mobile-phone handset located within a few metres of the body. This protocol provides for RF transmissions in the frequency range 2.4–2.5 GHz at power levels of 1, 2.5 or 100 mW. Only the lowest of these power levels would be used with a wireless hands-free kit and these are around a hundred times lower than the maximum output powers of mobile phones. In the study on wired hands-free kits mentioned above, [Kühn et al. \(2009a\)](#) also tested Bluetooth wireless hands-free kits and concluded that they are responsible for a low but constant exposure.

(v) *Mobile-phone base stations*

The base stations that provide mobile-phone services to come in many different sizes and shapes, according to their individual coverage requirements.

The radiated powers and heights of mobile-phone base-station antennae are highly variable. [Cooper et al. \(2006\)](#) collected data on base-station antenna height and power from all cellular operators in the United Kingdom, a total of 32 837 base stations, for the year 2002. The data are presented in Fig. 1.10 and show that base-station powers typically vary from about 0.1 W to 200 W and that heights range from about 3 m to 60 m above ground level. There is a large group of base stations with heights in the range 15–25 m and powers in the range 20–100 W, and a second group with heights in the range 2–6 m

and powers of about 2 W. [Cooper et al.](#) concluded that the base stations in the first group are likely to serve macrocells and provide the main coverage for cellular networks, while those in the second group are likely to be microcells and provide a second layer of coverage, e.g. in densely populated areas.

Numerous spot measurements have been carried out to determine levels of exposure in the vicinity of mobile-phone base stations, often within national campaigns to address public concerns. Generally, these spot measurements take into account exposure contributions from all signals in the bands used by the base station at the time of measurement, but ignore other parts of the spectrum, such as those used by broadcast transmitters. [Mann \(2010\)](#) summarized the United Kingdom audit programme, which encompassed 3321 measurements at 541 sites comprising 339 schools, 37 hospitals and 165 other locations. Exposure quotients, describing the fraction of the ICNIRP general public reference level ([ICNIRP, 1998](#)) that is contributed collectively by the signals measured, are shown in Fig. 1.11 as a cumulative distribution.

Fig. 1.11 includes a log-normal curve fitted optimally (least squares) to the data. The curve suggests that the data are approximately log-normally distributed, although with a longer tail towards the lower values. The quotient values are 8.1×10^{-6} ($3.0 \times 10^{-8} - 2.5 \times 10^{-4}$), where the first figure is the median value and the values in parentheses indicate the range from the 5th to the 95th percentile. About 55% of the measurements were made outdoors and these were associated with higher exposure quotients than the indoor measurements. The median quotients for the outdoor and indoor measurements were 1.7×10^{-5} and 2.8×10^{-6} respectively, i.e. the outdoor median was around six times higher than the indoor median ([Mann, 2010](#)).

The exposure quotients may be converted to electric-field strengths or power densities by assuming a value for the reference level, but the

Fig. 1.10 Distribution of 32 837 base stations in the United Kingdom according to average antenna height and total radiated power

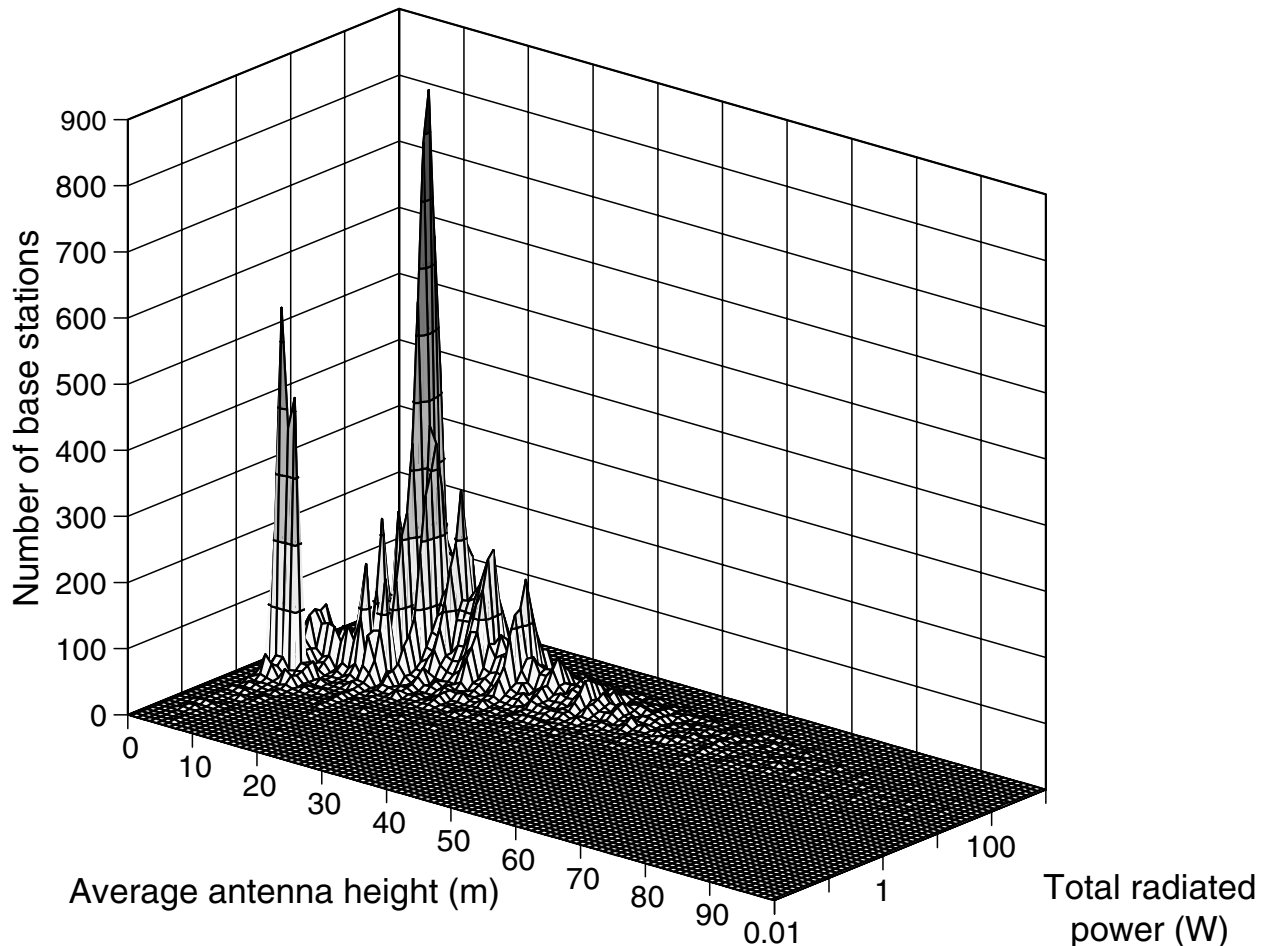

Antenna height is given as an average value since some base stations with multiple antennae have the antennae mounted at different heights. From [Cooper et al. \(2006\)](#)

latter varies from 2 to 10 W/m² over the frequency range considered in the measurements (TETRA at 390 MHz to UMTS at 2170 MHz). The variation of the reference level is, however, very much less than the variation in the exposure quotients, so taking 4.5 W/m² as the reference level (the value at 900 MHz) still yields useful data. The power densities and electric-field strengths based on this assumed value are shown in [Table 1.6](#).

[Table 1.6](#) shows electric-field strengths that range from about ten to a few hundred millivolts per metre indoors, where people spend most of their time. However, in considering these data it

is important to recognize that the indoor sites in this study were selected according to public concern regarding a nearby base station; these field strengths may thus be higher than would be found at locations representative of exposure of the general population.

[Petersen & Testagrossa \(1992\)](#) published measurements of power densities around analogue base-station sites in the USA, transmitting in the frequency range 869–894 MHz. A basic start-up site would serve a cell with a range of up to 12–16 km and provide up to 16 signals (each serving one phone call) from a

Fig. 1.11 Cumulative distribution of exposure quotients corresponding to 3321 spot measurements made by Office of Communications at 499 sites where public concern had been expressed about nearby base stations

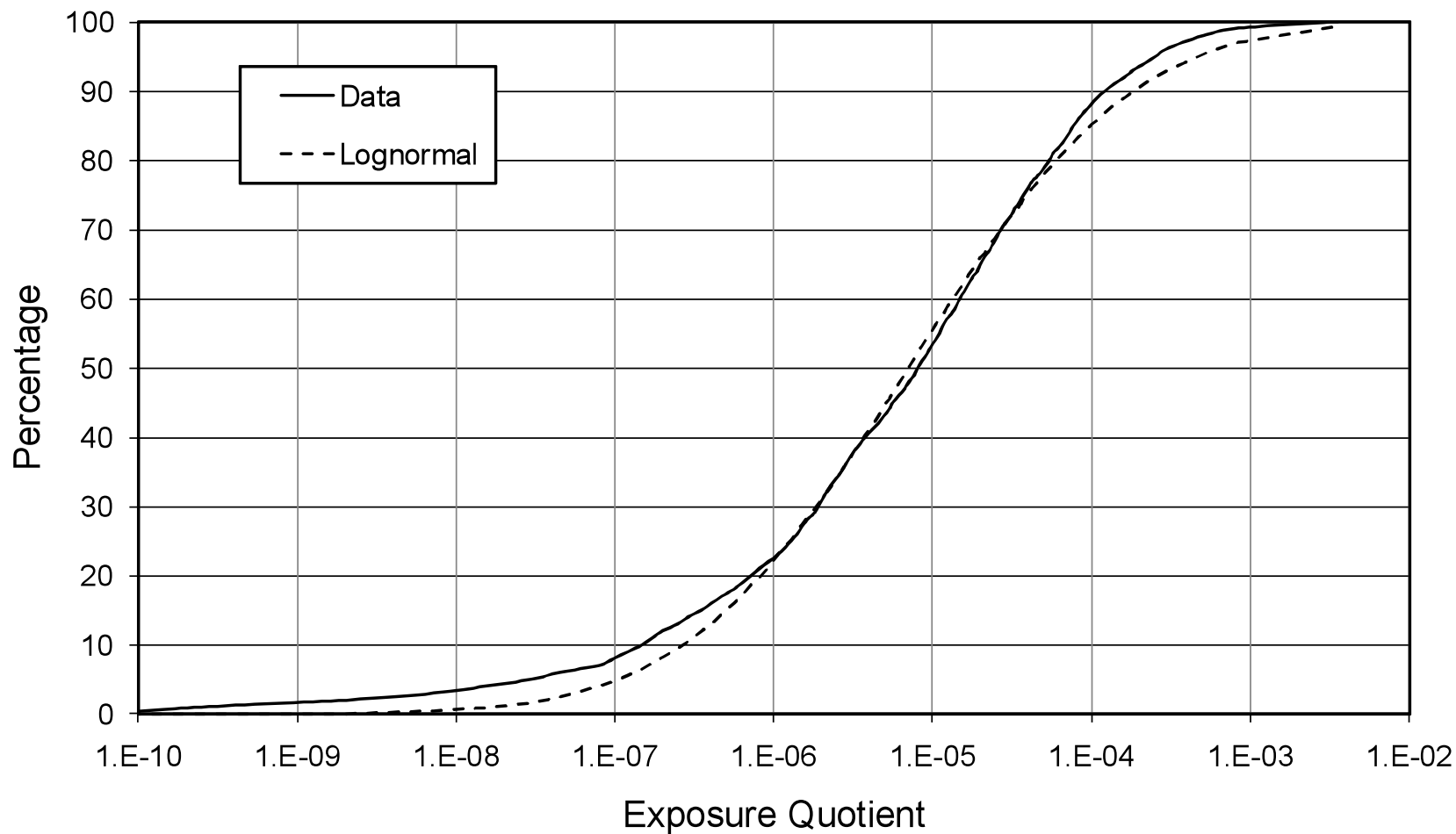

The exposure quotients were calculated by dividing the power density of each individually measured signal by the general public reference level at its frequency according to [ICNIRP \(1998\)](#) and then summing these individual signal quotients to obtain a total quotient of the reference level. The figure shows a log-normal curve fitted to the data. From [Mann \(2010\)](#). Copyright © 2010. Published by Elsevier Masson SAS on behalf of Académie des sciences. All rights reserved.

Table 1.6 Summary of exposure quotients measured in the United Kingdom

Category	No. of measurements	Exposure quotient ($\times 10^{-6}$)		Power density ($\mu\text{W}/\text{m}^2$)		Electric-field strength (mV/m)	
		Median	Range ^a	Median	Range ^a	Median	Range ^a
All data	3321	8.1	0.03 – 250	37	0.13 – 1100	120	7.1 – 650
Outdoor	1809	17	0.052 – 314	77	0.23 – 1400	170	9.3 – 730
Indoor	1516	2.8	0.024 – 124	13	0.11 – 560	69	6.4 – 460

^a Range from 5th to 95th percentiles

These data are from an audit of base stations up to the end of 2007. Equivalent power densities and electric-field strengths are given assuming a reference level of $4.5 \text{ W}/\text{m}^2$.

Adapted from [Mann \(2010\)](#)

single omni-directional antenna. As demand grew, sites could be expanded to split cells into three sectors with up to six antennae mounted on a triangular mast head. Again, each antenna would provide up to 16 signals, so there would be a maximum of 96 signals available, 32 of which would have been directed into each sector. Values for nominal ERP (see Glossary) were about 100 W and so the radiated power would have been of the order of 10 W per signal from omni-directional and sectored sites, with typical antenna gains in the range of 9–10 dB and 8–12 dB, respectively.

For four masts ranging from 46 to 82 m in height, measurements were made at intervals along radials from the bases of the masts out to distances of a few hundred metres. Individual signals from a given antenna were found to vary in strength at any given measurement position and the sidelobe structure of the antenna was evident in that the signal strength had an oscillatory dependence on distance. The maximum power density per signal was $< 100 \mu\text{W}/\text{m}^2$, except in proximity to metal structures near the foot of the tower. Thus, even for 96 signals transmitted simultaneously, the maximum aggregate power density possible would have been $< 10 \text{ mW}/\text{m}^2$.

[Henderson & Bangay \(2006\)](#) reported on a survey of exposures around 60 base station sites in Australia transmitting CDMA800 (29 sites), GSM900 (51 sites), GSM1800 (12 sites) and 3G UMTS (35 sites) signals. Initially, computer modelling was carried out to identify

the direction from the mast where maximum exposures were expected. Measurements were then made at distances of 50, 200 and 500 m, and further measurements were then made at the distance where maximum exposures were predicted, which varied from 14 to 480 m from the mast as a consequence of antenna height, pattern and tilt. The maximum recorded power density of $7.8 \text{ mW}/\text{m}^2$ corresponded to an exposure quotient of 0.002 (0.2%) relative to the ICNIRP public reference level (identical to the Australian standard at the frequencies concerned). The cumulative distributions also reported in this paper showed roughly similar median exposure quotients of about 0.0015 at 50 and 200 m, 0.0001 at 500 m and 0.004 at the maximum.

The study by [Cooper *et al.* \(2006\)](#) mentioned above focused on measurements around 20 GSM base stations with powers $< 5 \text{ W}$ and heights $< 10 \text{ m}$, selected randomly from all base stations in the United Kingdom. From the total of 32 837 base stations, 3008 eligible stations were identified. The antennae of the selected base stations were often fixed to the walls of buildings at a minimum height of 2.8 m. Theoretical calculations based on the radiated powers showed that the minimum height at which the reference level could be reached was 2.4 m above ground. Exposure measurements were made as a function of distance at 10 of the 20 sites and at 610 locations in total, ranging from 1 to 100 m from the antenna. The highest spot measurement at

an accessible location represented 8.6% of the reference level and the exposures more generally ranged from 0.002% to 2% of the ICNIRP public reference level. Empirical fits showed that the exposure quotients decreased in a way that was inversely proportional to the distance, for distances up to about 20 m from the antennae and thereafter diminished with the fourth power of distance. Exposures close to microcell base stations were found to be higher than close to macrocell base stations, because the antennae were at lower heights and could be approached more closely by the public.

[Kim & Park \(2010\)](#) made measurements at 50 locations between 32 and 422 m from CDMA800 and CDMA1800 base stations in the Republic of Korea. The base stations were selected to represent locations where concern had been expressed by the local population. The highest reported electric field level was 1.5 V/m, equivalent to an exposure quotient of 0.0015 (0.15%) compared with the reference level, and the median exposure quotient was below 0.0001 (0.01%).

The most recent studies have used personal-exposure meters worn for periods of up to several days by groups of volunteers. These studies are covered in Section 1.6.1, and provide information not only on exposure from base stations, but also from other environmental transmitters during typical activities.

(vi) *Terrestrial Trunked Radio (TETRA)*

TETRA is a cellular radio system designed to meet the needs of professional users and emergency services. The handsets can be used like mobile phones, but are normally used as walkie-talkies, held in front of the face and in push-to-talk (PTT) mode. Remote speaker microphones and a variety of covert add-ons are also available. When the handsets are used with accessories, the transmitting handset may be mounted on the belt, on the chest, or elsewhere on the body. Systems for use in vehicles with the transmitting antennae mounted externally are also available.

The operating principles and the detailed characteristics of the signals involved are described in a review by [AGNIR \(2001\)](#).

Several frequency bands are available between 380 and 470 MHz, as well as one set of bands near 900 MHz. Handsets can have peak emitted powers of 1 W or 3 W, while vehicle-mounted transmitters can have powers of 3 W or 10 W. Base stations have similar powers to those used for mobile-phone networks, i.e. a few tens of watts. The system uses TDMA, although the frame rate is slower than that of the TDMA systems involved with mobile phones. There are four slots per frame and 17.6 frames per second. Hence, the bursts from handsets occupy slots with a duration of 14.2 ms and the time-averaged power is a quarter of the peak powers mentioned earlier in this paragraph. The base stations transmit continuous signals [AGNIR \(2001\)](#).

The AGNIR review refers to SARs measured from 1 W and 3 W handsets held to either side of the head and in front of the face in a model of the head. With spatial averaging over 10 g, as per ICNIRP and IEEE exposure guidelines, the 1 W radio produced SARs of 0.88, 0.89 and 0.24 W/kg on the left, right and front of the face, respectively, while the 3 W radio produced SARs of 2.88, 2.33 and 0.53 W/kg, respectively, under the same conditions.

[Dimbylow *et al.* \(2003\)](#) developed a numerical model of a commercially available TETRA handset and calculated SARs in an anatomically realistic numerical model (resolution, 2 mm) of the head developed from MRI images. The handset was modelled as a metal box of dimensions 34 × 50 × 134 mm, and with either a helical (pitch, 4 mm; diameter, 8 mm) or a monopole antenna mounted on its top face, and resonant at 380 MHz. For the handset held vertically in front of the face in the position that was considered to be most representative of practical use, the averaged SARs at 10 g were 1.67 W/kg and 2.37 W/kg per watt of radiated power with the monopole and helical antennae, respectively. Various positions

were considered with the handset held to the sides of the head and the maximum SARs with the two antennae were 2.33 and 3.90 W/kg per watt. These values suggest SARs with 3 W handsets (3/4 W time-averaged) having a helical antenna could exceed the 2 W/kg restriction on exposure for the general public, if the handsets were to transmit at full power for 6 minutes while held to the side of the head.

(vii) Cordless phones

Cordless phones are used to make voice calls and are held against the head just like mobile phones. Hence, the antenna inside the phone is in close proximity to the head and its radiated fields deposit energy inside the head tissues near to the phone, in a similar way to the fields from mobile phones. With cordless phones, communications are made over shorter distances than with mobile phones and so the radiated powers used are lower, but cordless phones do not use adaptive power control, which means that, unlike mobile phones, they do not continually adapt their radiated power to the minimum necessary for satisfactory communication (ETSI, 2010).

With simple cordless installations, the phones are typically placed back on a desk or charging point after a call has finished. However, there are also more complicated installations in which multiple base stations are installed throughout a building and the phones are carried by the user as a personal phone. The radio communications are over distances of a few tens of metres and to the nearest base station, which provides the link into the main wired telephone system.

The first cordless phones used analogue technology and operated to a range of different technical standards, with continuous emitted power levels of about 10 mW during calls. Frequencies were generally in the range 30–50 MHz and therefore about 20 times lower than the frequencies used by mobile phones. Some phones used telescopic antennae of about 15–30 cm in length, while others used helical

antennae of about 5 cm in length. The lower frequencies and the greater size of the antennae used with analogue cordless phones would have resulted in a smaller proportion of the radiated power being absorbed, and also in a more diffuse pattern of absorption in the head than occurs with mobile phones (ETSI, 2010).

Modern cordless phones use digital technology, including the digital enhanced cordless telecommunications (DECT) technical standard, which operates in the frequency band 1880–1900 MHz and is the main system used in Europe. In other parts of the world, systems operating around 900, 2400 and 5800 MHz are used as well as DECT (ETSI, 2010).

DECT systems produce discontinuous emissions due to their use of TDMA. The signals from the phone and base station during calls are in the form of 100 bursts every second, each of about 0.4 ms in duration. These bursts are emitted at a peak power level of 250 mW, but the time-averaged power is 10 mW because each device only transmits for 1/24 of the time (duty factor of 4%). Handsets do not transmit unless calls are being made, but when on “standby” most base stations produce 100 beacon pulses per second, each pulse being 0.08 ms in duration. This implies a duty factor of 0.8% (ETSI, 2010).

(viii) Professional mobile radio systems

A variety of professional mobile radio systems, also called private mobile radio (PMR), have been developed over the years and these are generally licensed to professional users by spectrum-management agencies in the countries where they are used. In many countries, the emergency services (police, fire, ambulance, etc.) are converting to the use of digital cellular systems, such as TETRA, although analogue systems – which were the norm before roll-out of TETRA systems – are also used.

The PMR systems use frequencies in the VHF and UHF parts of the spectrum; VHF generally propagates further for a given radiated power

and is, therefore, preferred for longer-distance communications. On the other hand, UHF systems have smaller antennae and present as more compact terminals.

Systems exist in the form of walkie-talkies that are held in front of the face and used in push-to-talk (PTT) mode; they may be built into vehicles with external, e.g. roof-mounted, antennae or be worn on the body. The transmitting antennae can be on the handset itself, on the vehicle, or carried on the chest or waist. The radiated powers are typically in the range 1–5 W, but it is important to take into account the duty factor associated with how they are used: the PTT mode will involve only a few seconds of transmission during the time that the button is pressed down and the user is speaking.

(c) *Wireless networks*

Wireless networking has developed rapidly since about 2000 and is becoming the method of choice for connecting mobile devices such as laptop computers and mobile phones to other electronic systems and to the Internet. The networks are found in homes, schools, public places such as cafés and transport hubs, and in the workplace. The systems operate to the IEEE802.11 family of technical standards and are often known as “Wi-Fi,” after the Wi-Fi Alliance, an organization that certifies inter-operability of devices on the market.

The original version of IEEE802.11 was published in 1997 and provided for data-transfer rates of up to 2 Mbit/s through frequency channels between 2.4 and 2.5 GHz. Subsequent developments using this band were IEEE802.11b and IEEE802.11g, allowing for rates up to 11 and 54 Mbit/s, respectively. Several frequency bands between 5 and 6 GHz are exploited by IEEE802.11a and provide for 54 Mbit/s communications. The latest devices operate according to IEEE802.11n and provide up to 72 Mbit/s in a single frequency channel, but the standard allows for devices that can use multiple frequency

channels simultaneously to deliver much higher data rates ([ICNIRP, 2009a](#)).

The IEEE802.11 standard specifies maximum radiated powers, but these are above the values permitted by regulatory agencies in many parts of the world. For example, in Europe the technical standards EN300328 and EN301893 limit the EIRP to 100 mW in the 2.4-GHz band and 200 mW in the 5 GHz band, respectively. [Peyman et al. \(2011\)](#) measured the actual power radiated by a selection of Wi-Fi devices marketed among schools in the United Kingdom. The spherically integrated radiated power (IRP) ranged from 5 to 17 mW for fifteen laptops in the 2.45 GHz band and from 1 to 16 mW for eight laptops in the 5 GHz band. For practical reasons and because access points are generally wall-mounted with beams directed into the room, their powers were integrated over a hemisphere. These ranged from 3 to 28 mW for twelve access points at 2.4 GHz and from 3 to 29 mW for six access points at 5 GHz. Thus the radiated powers of laptops seem to range from a few mW up to about 30 mW. In principle, these measurements imply that the powers of access points could range from a few mW up to around 60 mW, if their patterns extend symmetrically into the unmeasured hemisphere, which seems unlikely.

The RF emissions from Wi-Fi devices are in the form of short bursts containing portions of the data being transmitted and other information, such as acknowledgements that data have been successfully received. Unlike the emissions from mobile phones using TDMA, the bursts are irregular in terms of timing and duration. Typical bursts range from about 10 μ s to about 1 ms in duration. If data are lost or corrupted during transmission, bursts are retransmitted until they are successfully received. Also, under conditions where communications are poor, e.g. due to weak signal strength, the systems can lower their data-transfer rates to have better signal-to-noise ratios and improved reliability. This increases the cumulative time that it takes to transmit a given

amount of data. Thus, high signal strengths from Wi-Fi devices (during transmission of bursts) do not necessarily translate to higher exposures, because this results in lower duty factors ([Mann, 2010](#)).

Comprehensive data are yet to be published regarding the duty factors of Wi-Fi equipment during normal use; however, [Khalid et al. \(2011\)](#) has reported initial results from the use of data-traffic capturing and packet-counting equipment in school networks. Transmitted bursts were captured to determine the proportion of time during which Wi-Fi devices transmitted while children were using laptops during their lessons. The laptops were mostly used for receiving traffic from the access points and therefore laptop-transmit times were low. Duty factors for the monitored laptops were consistently less than 1% and those of access points were less than 10%. Baseline duty factors of access points (with no data being transferred) are about 1%, due to beacon pulses of duration 1 ms that are produced at a rate of ten pulses per second ([Mann, 2010](#)).

The SAR values produced when using laptop computers equipped with Wi-Fi transmitters have been evaluated by several authors. Most devices now have built-in antennae located around and along the top edge of the screen, which are therefore at greater distances from the body than a mobile phone held against the head. The rapid reduction in field strength that occurs with increasing distance means that SARs can be expected to be much lower than from mobile phones under such scenarios. Based on a continuous radiated power of 100 mW under a range of such scenarios, [Findlay & Dimbylow \(2010\)](#) calculated a maximum 10 g averaged SAR of 5.7 mW/kg in the head.

When Wi-Fi devices are able to transmit continuously with their antennae in close proximity to the body, the SARs may be higher than in the scenario described above. For example, [Kühn et al. \(2007a\)](#) measured a SAR of 0.81 W/kg in a flat phantom with the antennae of a Wi-Fi

access point in close proximity and [Schmid et al. \(2007b\)](#) measured a SAR of 0.05 W/kg under similar conditions from a Wi-Fi equipped PCI card inserted into a laptop. The value reported by Kühn et al. is within the range of maximum localized SARs from mobile phones ([ICNIRP, 1998](#)).

Studies have also examined the general field strengths in environments where Wi-Fi networks are installed. [Foster \(2007\)](#) measured RF fields at 55 public and private sites in the USA and Europe (4 countries), which included private residences, commercial spaces, and health-care and educational institutions. In nearly all cases, the measured Wi-Fi signal levels were far lower than other RF signals in the same environment. The maximum time-averaged power density in the 2.4-GHz band measured at 1 m distance from a laptop uploading and downloading a file was 7 mW/m², which is far less than the [ICNIRP \(1998\)](#) reference level value of 10 W/m² for the general public.

[Schmid et al. \(2007a\)](#) investigated the typical exposure caused by wireless local area network (WLAN) applications in small and large indoor public areas (e.g. Internet cafés, airports). Outdoor scenarios were also considered where the exposure was measured in the vicinity of access points serving residential areas and public places. Exposure was assessed by computational methods and by on-site measurements. The highest values for indoor exposure were found close to the transmitting devices (access points or clients) where, at a distance of about 20 cm, spatial and temporal peak values of power density were found to reach about 100–200 mW/m². In general, the exposure values were several orders of magnitude below the [ICNIRP \(1998\)](#) reference levels.

(d) Industrial applications

There are several industrial applications for RF-EMF, many of which are described in review reports and papers. On the whole, the

literature is rather old and difficult to interpret since reported field values have generally been taken in the context of compliance assessments rather than epidemiological studies, so it is hard to judge what the typical exposures of workers may have been. Only a brief description of some of the sources producing the highest exposures is included here.

(i) *Industrial induction heating*

Industrial induction heating involves the use of induction furnaces equipped with large coils that produce strong magnetic fields. Conducting materials for treatment are placed inside the coils and the magnetic fields cause eddy currents, resulting in heating of the conducting materials. Typical applications include surface hardening, softening and melting metals, mixing alloys and heating gaseous conductors such as plasmas. The frequencies used span a wide range, from 50 Hz through to a few megahertz, so not all applications fall within the scope of this *Monograph*. The fields can be considerable and worker exposures are greatest for tasks that involve approaching the coils, e.g. when taking samples from within the coils of open furnaces. The coil impedances increase with frequency and electric fields can become the dominant contributor to exposure (rather than magnetic fields) at frequencies above about 100 kHz ([ICNIRP, 2009a](#)). [Allen et al. \(1994\)](#) have provided a review of measured exposures, drawing on peer-reviewed papers from several countries and measurements made in the United Kingdom.

(ii) *Dielectric heating*

RF heating and drying equipment has been used for many years and applications include pre-heating, wood-glueing and polyvinyl chloride (PVC) welding. These materials are lossy dielectrics and their conductivity at radiofrequencies means that they can become heated-up when placed in a strong electric field. Typical heaters are designed to use the industrial, scientific and

medical (ISM) bands at 13.56, 27.12 and 40.68 MHz, but reported measurements show that frequencies are variable within the range 10–80 MHz. Powers range from less than a kilowatt to tens of kilowatts for typical heat sealers, while for glue-dryers the maximum power may exceed 100 kW ([ICNIRP, 2009a](#)).

The greatest source of operator exposure comes from the use of manually actuated PVC dielectric machines, where the operator manipulates material to be welded by hand and then clamps it between a pair of electrodes between which the power is applied. Measurements and other details from studies carried out in the United Kingdom and elsewhere are described by [Allen et al. \(1994\)](#). The field strengths from dielectric heaters at the operator locations can be in excess of the [ICNIRP \(1998\)](#) reference levels, but they are non-uniform and it is necessary to evaluate the SAR in the body to determine compliance with the guidelines. [Kännälä et al. \(2008\)](#) have developed an assessment method based on measuring induced limb currents and relating these to localized and whole-body SARs (wbSARs).

(e) *Medical applications*

RF fields have several medical applications. In general, exposure for the clinician will be lower than for the patient, since the RF source will generally be located closer to the patient, but this is not always the case. RF fields can also be applied for therapeutic purposes, for moderate heating of tissue, or for much greater heating for the cutting and destruction of tissue during surgery.

(i) *Magnetic resonance imaging (MRI)*

Performing an MRI scan for diagnostic purposes involves strong RF fields. MRI uses a combination of EMFs to produce exceptionally clear images of tissue structures inside the human body, to assist with medical diagnoses. Hydrogen atoms associated with water in the

body tissues are made to resonate in a strong magnetic field such that they emit RF radiation at the resonant frequency. Therefore, variations in the water content of tissues are the basis of the contrast in the images obtained ([HPA, 2008](#)).

A permanent uniform static magnetic field, typically in the range 1–3 T, but sometimes up to 8 T or more with specialized systems, is applied over the body and causes splitting of the energy states associated with protons (hydrogen atoms). The difference between the energy states is such that protons will transfer from the lower to the upper energy state in response to an applied RF signal at the resonant frequency. Protons will also fall back to the lower energy state spontaneously, and in doing so emit RF radiation at the Larmor frequency. The Larmor frequency is given by 42.57 times the static magnetic-field strength. Thus a 1.5 T, an MRI scan involves the application and measurement of RF fields at 64 MHz ([HPA, 2008](#)).

During an MRI scan, multiple RF pulses (hundreds to thousands per second) are applied over either the whole body or the part of the body being visualized. The RF dose (SAR) received by patients inside the MRI scanners is reported by the system and can vary from < 0.1 W/kg to about 4 W/kg for more complex settings ([HPA, 2008](#)). The desire to limit temperature increases and prevent harm to the patient can be a limiting factor in how quickly scans can be performed in practice. Clinicians and any other personnel who are near to the magnet during the scans will be exposed to the RF fields, but the strength of the RF fields will diminish rapidly with increasing distance from the RF coils and the space between them inside the scanner.

(ii) Diathermy

Short-wave and microwave diathermy are used to gently warm muscles, tendons and joints to alleviate a variety of medical conditions. Short-wave equipment operates at frequencies of 13.56 MHz or 27.12 MHz and powers of about

400 W. Applicators for microwave diathermy operate at 2.45 GHz with powers of about 200 W and tend to take the form of a radiating antenna surrounded by reflectors that direct the emitted energy in a forward direction. While exposure of the patient is intentional, the scanner operators close to the equipment may be exposed involuntarily in areas where field strengths are high, unless they move away while the equipment is in operation ([ICNIRP, 2009a](#)).

(iii) Surgical diathermy and ablation by radiofrequency

RF fields and currents are widely used during surgical procedures. In surgical diathermy or electrosurgery, a small hand-held electrode acts as a cutting or coagulation instrument. The basic operating frequency is typically about 500 kHz and there are harmonics produced at frequencies up to around 20 MHz. Current densities in tissues can be as high as 10 A/cm² with source powers of up to 200 W ([IPEM, 2010](#)). Some more recent systems use a frequency of 9.2 GHz and powers of about 20 W delivered through needle-like electrodes containing coaxial lines. These systems are employed for minimally invasive surgery, e.g. focal tumour ablation and the treatment of menorrhagia by endometrial ablation ([IPEM, 2010](#)).

(f) Domestic sources

There are few powerful sources of RF in the home; however, among these, induction cooking hobs and microwave ovens are of note. Less powerful sources include remote-controlled toys, baby monitors, and the mobile/cordless phones and the Wi-Fi systems described earlier.

Induction cooking hobs feature coils that produce a magnetic field beneath the metal cooking pans that are placed on them. The magnetic fields produce eddy currents in the pans, which are thereby heated. The powers transferred to the pans can be several kilowatts and the frequencies involved are in the range

20–50 kHz. Magnetic fields can be in the order of the ICNIRP reference levels, but vary greatly with user position and also depend on the placement of the pan. [ICNIRP \(2009a\)](#) reviews studies that have investigated these exposures.

Microwave ovens are standard fixtures in many homes and contain microwave sources operating at a frequency of 2.45 GHz and producing powers between 500 W and 2 kW. The design of such ovens is such that leakage is kept to a minimum and a product-performance technical standard requires that microwave-power density levels fall below 50 W/m² at a distance of 5 cm. Several large surveys of leakage levels have been performed, as described in [ICNIRP \(2009a\)](#), and these indicate that approximately 99% of ovens comply with the emission limit. According to the measurements of [Bangay & Zombolas \(2003\)](#), the maximum local SAR values at the emission limit are 0.256 W/kg and the maximum 10 g averaged SAR is 0.0056 W/kg.

A new source of RF that is currently being introduced and that seems set to enter many homes is the transmitter associated with “smart” metering of electricity consumption and potentially metering for other services such as water and gas. There is no global approach to gathering information from smart meters and relaying it back to the utility companies, but it is clear that radio communications will be involved. Some systems may use mobile-phone networks for this purpose, while others may use dedicated radio infrastructures. Some systems may also involve a home area network (HAN) within which individual electrical devices in the home can relay information about usage to a central collection point, allowing residents to examine the information and make decisions about their energy consumption. Two recent investigations commissioned by the Electric Power Research Institute (available on the EPRI webpage) suggest that the power level of radio transmissions will be similar to that of mobile phones, but that the duty factors will be low (on average, such devices

will transmit for a small proportion of time only). Low duty factors, combined with the greater distances of these devices from people compared with mobile phones, imply that exposures will be low when compared with exposure guidelines.

(g) Security and safety applications, including radar and navigation

A variety of systems used for security purposes involve the application of RF, including systems for asset tracking and identification. These sources and exposures have been reviewed in [ICNIRP \(2009a\)](#).

Radar systems operate across a broad range of frequencies, mostly in the range 1–10 GHz, with some short-range applications in the range of tens of gigahertz. Emissions from these systems represent an extreme form of pulse modulation, the TDMA scheme used by some mobile phones being a less extreme example. The duty factor in a GSM TDMA signal is 1/8, whereas it is typically around 1/1000 with a radar signal. The typical duration of a pulse might be about a microsecond, while a typical pulse period might be about a millisecond, although these parameters do vary and depend on the type of radar involved. Very high power densities can be produced in the antenna beams during the pulses, and powers can still be high after duty factors are taken into account to determine the average power. To assess human exposure from radar systems it is necessary to take into account:

- The exposure metric of interest (to account for the pulsing, or simply based on the average power);
- People’s juxtaposition to the beams (are the beams going over people’s heads?);
- The duty factor associated with the pulsing;
- The duty factor associated with rotation (equal to the beam width in azimuth divided by 60 degrees; probably around 200 : 1 in the direction that a rotating beam sweeps through).

Information about radar systems can be found in the following review reports: [Allen et al. \(1994\)](#), [Cooper \(2002\)](#) and [ICNIRP \(2009a\)](#).

(i) *Air traffic control*

The most familiar application of radar is for navigation and the tracking of aircraft movements from rotating ground-based antennae, e.g. at airports. Long-range systems operate over 1–2 GHz, while moderate-range systems operate over 2–4 GHz. The antennae tend to be mounted sufficiently high that buildings cannot obstruct their view of the sky and they form narrow beams of about a degree in the horizontal plane that sweep around 360 degrees once every few seconds. Beams are broader in the vertical plane and tail off in strength towards low elevation angles to avoid reflections from objects on the ground. Aviation radar systems have quite high emitted power levels during the pulses, typically from tens of kilowatts to a few megawatts. Taking the duty factors into account leads to time-averaged emitted powers of about 100 W to a few kilowatts ([AGNIR, 2003](#)).

(ii) *Marine radar*

Marine radar systems are used to inform the crew of a ship of the presence of other vessels and thus avoid collisions. The range of these systems is shorter than that of aviation systems. It is known that targets will be at ground (sea) level, so the beam profile extends to ground level in the plane of elevation. The rotating antennae are mounted at height to allow a view of the sea that is unobstructed by the structure of the ship/vessel on which they are carried. Operating frequencies are in the ranges of 2–4 or 8–12 GHz. Mean powers are in the range 1–25 W and peak powers can be up to about 30 kW ([ICNIRP, 2009a](#)).

(iii) *Tracking radar*

Tracking radar is used in military systems to lock-on to and follow targets such as aircraft and missiles. The antennae can rotate, execute a nodding motion, point in a fixed direction, or

follow a target. Targets are not expected to assist with being tracked and may even be designed with stealth in mind and to suppress the extent to which they reflect radar pulses. Hence, tracking radar systems generally involve higher powers than navigation systems and use peak powers of up to several megawatts. Systems mostly operate between 2 and 8 GHz. Certain tracking radar systems can produce mean power densities $> 100 \text{ W/m}^2$ at distances in excess of a kilometre, even after duty-cycle correction ([ICNIRP, 2009a](#)).

(iv) *Whole-body security scanners*

Whole-body security scanners are used in places such as airports to generate images of objects carried under people's clothing without the need for physical contact. Active systems transmit either ionizing (X-rays) or non-ionizing (RF) radiation towards the body and then analyse the scattered radiation. Passive systems simply monitor the "black body" (thermal) radiation given off by the body in the RF spectrum and do not emit any radiation. Current active RF systems typically operate at about 30 GHz, although in the future systems may use frequencies of up to several hundred gigahertz. ([European Commission, 2010](#)). A note published by [AFSSET \(2010\)](#) described an assessment of an active scanner operating in the frequency range 24–30 GHz. Power densities incident on the body were reported as between 60 and 640 $\mu\text{W/m}^2$.

(v) *Other systems*

Various other radar systems include those used for monitoring weather, traffic speed, collision avoidance with vehicles and ground penetration.

1.3 Dosimetry

1.3.1 Introduction

Incident EMFs are defined as external fields in the absence of – i.e. without interaction with – the human body, animals, or tissue samples. Incident fields couple with the human body and induce EMFs and currents inside the body tissues.

Macrodosimetry is the science of quantifying the three-dimensional distribution of EMFs inside tissues and organs of biological bodies, with averaged induced fields across submillimetre tissue structures (e.g. cells). The term is also applied to measurements in media that have dielectric characteristics similar to those of biological bodies, e.g. cell cultures, tissue-simulating media, etc. The induced fields are the only exposure parameters that can interact with biological processes and, therefore, provide the primary exposure metric ([Kühn, 2009](#)).

Microdosimetry refers to the assessment of fields at subcellular resolution (e.g. across membranes, proteins, etc.). This is a relatively new research area that faces various basic problems, such as material models and transitions between classical and quantum electrodynamics. In all cases, however, macrodosimetry is the first step, since microdosimetry can only be developed from the locally averaged induced fields. This *Monograph* does not cover microdosimetry, and “dosimetry” used hereafter thus refers to macrodosimetry. Dosimetry studies of differences in dielectric properties of tissues in human and animals models published since 1984 are described in [Table 1.7](#).

The coupling mechanisms of the electric and magnetic incident-field components are different. Hence, both must be determined separately to fully characterize human exposure. Since coupling with the human body also depends on the ratio of wavelength versus body size, the RF-EMF spectrum is often divided

into at least three ranges, e.g. 30 kHz–10 MHz (below body resonance); 10 MHz to 2 GHz (body and partial body resonances); and 2 GHz to 300 GHz (surface-dominated absorption) ([ICNIRP, 2009a](#)). Furthermore, the distribution of the induced field strongly depends on various parameters, such as source (strength, frequency, polarization, direction of incidence, size, shape, etc.), distance and location of the source with respect to the body, outer anatomy, inner anatomy, body posture, and environment of the body (e.g. reflective objects).

The field variations within the body are generally large and may well exceed a factor of thousand for the locally absorbed energy. In general, field distributions change considerably between different postures and orientations of the body with respect to the field. For example, the exposure of the brain may change even though the whole-body average and the peak spatial absorption remain the same.

1.3.2 Dosimetric exposure

It has only recently become technically possible to achieve a detailed characterization of exposure to EMFs. Hence, research on dosimetry during the past 30 years has been focused on reliable determination of the exposure metric as defined in the safety guidelines, namely, the maximum average whole-body values and the maximum locally-induced field values. The most commonly used metrics are defined below.

At frequencies greater than 100 kHz, SAR is the main measure of exposure used. SAR is the absorbed electromagnetic energy per tissue mass and can be calculated directly from the electric energy loss, which is proportional to the square of the locally induced root-mean-square value (rms) of the electric field strength, the induced current density and the temperature increase (see Glossary for detailed equations). The assessment on the basis of the initial rise in temperature is only valid if the exposed body is in thermal

Table 1.7 Dosimetry studies of differences in dielectric properties of tissues

Reference	Description of the model	Main results and comments
Thurai et al. (1984)	Variation of dielectric properties of brain tissue of the mouse	Measurements were made on the cerebral cortex at frequencies of 10 MHz to 5 GHz in six groups of mice aged 3, 5, 19, 26, 33 or 58 days. Values of relative permittivity and conductivity are shown.
Thurai et al. (1985)	Dielectric properties of the developing rabbit brain	The dielectric properties of developing rabbit brain were measured at 37 °C, at frequencies between 10 MHz and 18 GHz, with time-domain and frequency-domain systems. Water dispersion in the brain becomes more complex with age.
Kuster & Balzano (1992)	Mechanism of energy absorption by biological bodies in the near field	Heterogeneous tissues and larger biological bodies of arbitrary shape are generalized for frequencies above 300 MHz. The SAR is found to be mainly proportional to the square of the incident H-field, which implies that in the close near field, the psSAR is related to the antenna current and not to the input power.
Lu et al. (1994)	Dielectric properties of human erythrocytes at radiofrequency	Dielectric properties of human erythrocytes in suspension (haematocrit, 50%) from 243 healthy persons (120 men, 123 women) were measured at 25 °C, at frequencies of 1–500 MHz, with a coaxial transmission line-reflection method (one-side measurement). A statistically significant age-dependence was found, with a critical age of about 50 yr, above which permittivity and conductivity of human erythrocytes in suspension decreased significantly.
Peyman et al. (2001)	Variation of dielectric properties of rat tissues by age, at microwave frequencies	The dielectric properties of tissues from rats of six different age-groups were measured at 37 °C in the frequency range 130 MHz to 10 GHz, with an open-ended coaxial probe. The percentage decrease in the dielectric properties of certain tissues in rats aged 30–70 days at mobile-phone frequencies was tabulated. These data contribute to rigorous dosimetry in lifetime-exposure animal experiments, and provide insight into possible differences in assessment of exposure for children and adults.
Peyman & Gabriel (2002)	Variation of dielectric properties of biological tissue, by age	Dielectric properties of the bone marrow generally decrease with age, due to changes in water content.
Jaspard et al. (2003)	Dielectric properties of blood, by haematocrit value	Two dielectric parameters appeared to be strongly dependent on the haematocrit value. The permittivity vs frequency decreases then increases when the haematocrit decreases. The conductivity increases in the whole frequency range when the haematocrit decreases.
Schmid et al. (2003)	Pre- and post-mortem dielectric properties of porcine brain tissue	Conductivity declined 15% (at 900 MHz) and 11% (at 1800 MHz) within 1 h after death, The decline in permittivity was 3–4%, and almost frequency-independent. In-vitro measurements of dielectric properties of brain tissue underestimate conductivity and permittivity of living tissue. These findings may affect generally accepted data on dielectric properties of brain tissue widely used in RF dosimetry.
Gabriel (2005)	Variation of dielectric properties of rat tissues, by age	Age-related dielectric data for 9 of 34 rat tissues were incorporated in a numerical dosimetry study on anatomically heterogeneous animals with body sizes corresponding to the ages of 10, 30, and 70 days, exposed to plane waves at spot frequencies from 27 to 2000 MHz. The variation in the dielectric properties affect the wbSAR by < 5%; the most conservative value (highest SAR) is obtained when 70-days properties are used. The dielectric properties of whole brain, skin, and skull were determined experimentally in the frequency range 300 KHz to 300 MHz.

Table 1.7 (continued)

Reference	Description of the model	Main results and comments
Lee et al. (2006)	Development of a body model for the Korean adult male	The dimensions of the human body vary by age, sex, and race. The internal structure and outer dimensions of a body exposed to an electromagnetic field are important for accurate dosimetry. Two volunteers with body dimensions representative of the average Korean adult male were recruited and scanned for phantom development by use of magnetic resonance and computed tomography. About 30 different tissues were manually classified by an anatomist on the raw images. The whole-body phantom can be used for radiation protection dosimetry.
Christ et al. (2006)	Electromagnetic near-field absorption in layered biological tissue in the frequency range 30–6000 MHz	The increase in SAR depends mainly on the thickness of the fat tissue and the frequency. For frequencies between 236 MHz and 5.8GHz, the peak spatial average SAR can increase by a factor between 1.6 and 3.5 compared with homogeneous tissue-simulating liquid. In the near-field zone, reactive E-field components give rise to increased peak spatial averaged SAR, due to high absorption in the skin
Peyman & Gabriel (2007)	Development and characterization of tissue-equivalent liquids	Dielectric properties of two tissue-equivalent liquids were measured in the frequency range 30–3000 MHz. A sucrose-based solution had a permittivity of 61.3 ± 1.0 and a conductivity of 0.63 ± 0.02 S/m at 30 MHz. An aqueous diacetone solution had a permittivity of 54.2 ± 1.2 and a conductivity of 0.75 ± 0.01 S/m at 30 MHz. At 150 and 300 MHz, the two liquids met the specified target to within 5% and 10%, respectively.
Peyman et al. (2007)	Dielectric properties of porcine cerebrospinal tissues <i>in vivo</i> , <i>in vitro</i> , and by systematic variation of age	Dielectric properties of pig cerebrospinal tissue were measured <i>in vivo</i> and <i>in vitro</i> , in the frequency range of 50 MHz to 20 GHz. The study <i>in vivo</i> included tissues from pigs of different ages, weighing about 10, 50 and 250 kg. Dielectric properties of white matter and spinal chord, but not grey matter, showed significant variation with age.
Lee et al. (2009)	Development of a body model for a Korean child aged 7 yr	A whole-body voxel model of a 7-yr-old male volunteer was developed from 384 axial MRIs. The model was adjusted to the physical average of Korean boys aged 7 yr. The body weight of the adjusted model, calculated with the mass-tissue densities, is within 6% of the 50th percentile weight.
Peyman et al. (2009)	Dielectric properties of tissues and SAR in children exposed to walkie-talkie devices	Dielectric properties of porcine tissues <i>in vitro</i> – measured from 50 MHz to 20 GHz – show significant reduction with age. Both permittivity and conductivity decreased in 10 out of 15 tissues measured, mainly due to reduction in the water content of tissues in the ageing animal. The results were then used to calculate the SAR values in children aged 3–7 yr exposed to RF induced by walkie-talkie devices. No significant differences between the SAR values for the children of either age or for adults were observed.

MRI, magnetic resonance imaging; RF, radiofrequency; SAR, specific absorption rate; wk, week or weeks; yr, year or years

equilibrium or in a steady thermal state at the beginning of the exposure.

The SARs usually reported are values averaged over time, either over the periodicity of the signal or over any period of 6 minutes. Two metrics are most often determined:

- The whole-body-averaged SAR (wbSAR) is the total electromagnetic power absorbed by a body divided by its mass.
- The maximum peak spatial SAR (psSAR) averaged over any cube inside the body with a tissue mass of 1 g (psSAR-1 g) or 10 g (psSAR-10 g). Specific evaluation rules have been defined in which the cube is grown around the observation point, whereas special rules apply in case of air interfaces (see [ANSI/IEEE, 2002a](#)). This value is usually reported independently of the exposed tissue.

In recent years, the focus has shifted towards more tissue-specific measures of exposure that can be correlated with biological effects ([Kuster et al., 2006](#); [Boutry et al., 2008](#)). Examples are:

- Instant, time-averaged or cumulative organ- and tissue-specific SAR;
- Distributions and histograms of the spatially averaged SAR (sSAR) values over a mass of 1 g or 10 g of tissue in the shape of a cube (sSAR-1 g or sSAR-10 g) or 10 g of contiguous tissue (sSAR-10 g c) (see also [Ebert, 2009](#)).

At frequencies below 10 MHz, the following quantities are used:

- Current density averaged over any 1 cm² of tissue from the central nervous system (CNS) perpendicular to the current direction ([ICNIRP, 1998](#));
- Electric field integrated over any line segment of 5 mm in length oriented in any direction within the tissue ([IEEE, 2005](#));
- Electric field averaged in any 2 × 2 × 2 mm³ volume ([ICNIRP, 2010](#)).

1.3.3 Coupling of incident fields with the body

(a) Body-mounted devices

For transmitters operating at frequencies greater than 300 MHz, the absorption in proximate human tissue is approximately proportional to the square of the incident magnetic field (H_{inc}) at the skin surface of the person exposed ([Kuster & Balzano, 1992](#)). H_{inc} is approximately given by the square of the equivalent RF current in the device (I_{RF}) divided by its distance from the human body (d).

The equations presented by these authors explain many aspects of human exposure to radiation from mobile phones discussed in this *Monograph*, namely:

- Mobile phones close to the body ($d < 0.01$ m) are the dominant source of exposure, particularly of the brain, when the phone is held at the ear, compared with exposure from the more powerful base stations at larger distances ($d > 10$ m).
- Exposure from a mobile phone operated by a bystander ($d < 1$ m) may still exceed the exposure from a base station at moderate distance.
- The absorption of energy by different tissues is strongly dependent on the design of the phone, and may vary more than 20-fold according to, e.g. the location of the antenna, and the current distribution with respect to the tissue ([Kuster et al., 2004](#)).
- The level of local exposure is also relatively strongly dependent on the position of the phone at the head, and may vary by a factor of more than 10 ([Wuart et al., 2007](#); [Gosselin et al., 2011](#)).
- The exposure of children is higher than that of adults by a factor of approximately two due to the different shape of children's heads, which brings the phone geometrically closer to the brain in children

Fig. 1.12 Variation in the whole-body specific absorption rate (SAR) produced per unit power density as a function of frequency in the adult male phantom NORMAN, and child phantoms of three different ages, standing on a conductive floor (grounded) and insulated

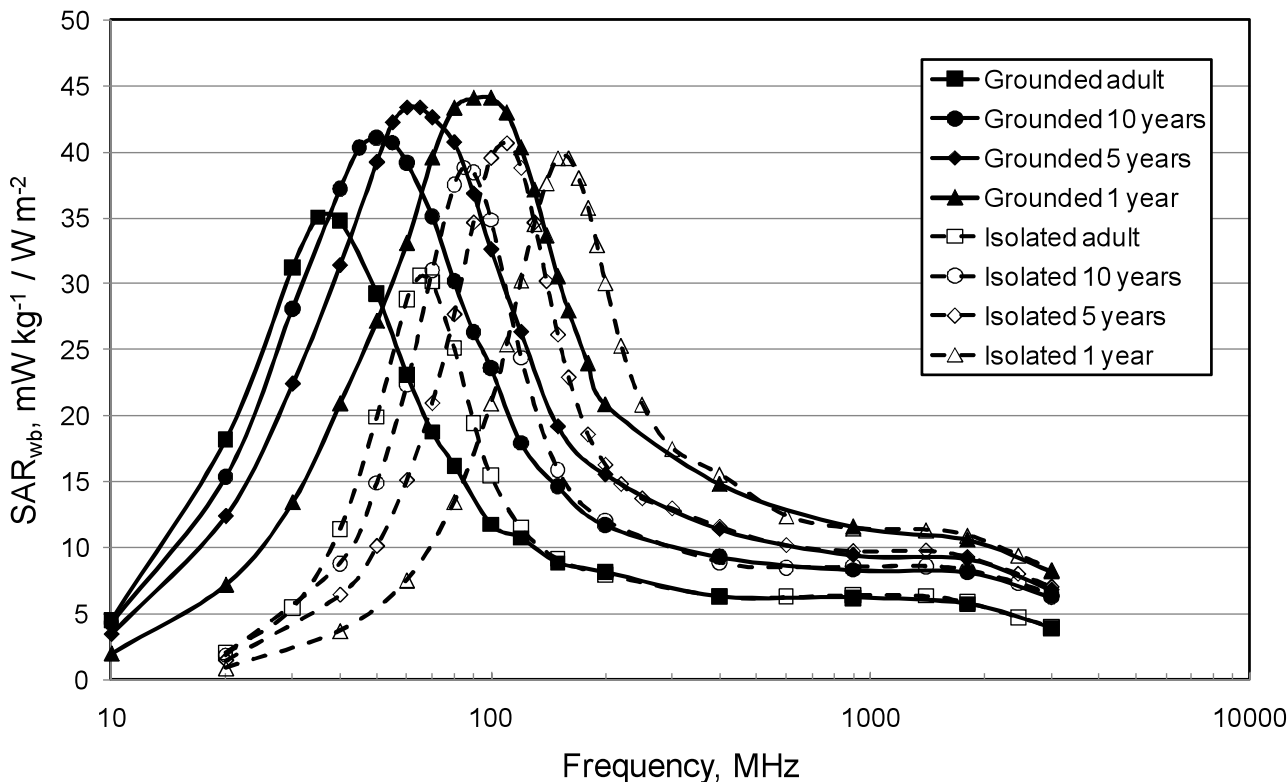

From Mann (2010). Copyright © 2010. Published by Elsevier Masson SAS on behalf of Académie des sciences. All rights reserved.

than in adults (see Section 1.6.1 (ii); [Wiart et al., 2008](#)).

- Hand-free kits reduce the psSAR in head tissue by a factor of 100 and more ([Porter et al., 2005](#); [Kühn et al., 2009b](#); also see Section 1.2.2).
- Bluetooth headsets operate at 1 mW and the maximum psSAR is a factor of about 100 lower than that for a mobile phone operating at the ear ([Kühn et al., 2007a](#)).
- WLAN transmitters in a laptop computer also result in lower exposures to the brain than a mobile phone operated at the ear.
- Exposures from DECT base-station antennae located in the same room as the person are similar to those from mobile-phone base stations in the neighbourhood ([Kühn et al., 2007a](#)).

(b) Whole-body and partial-body resonances

The human body can be described as an elongated poor conductor. Therefore, it couples energy best if the electric field is polarized along the long body axis and when the electrical length of the body is resonant, i.e. approximately half a wavelength ($\lambda/2$) for an ungrounded body and one quarter wavelength ($\lambda/4$) for a person standing on a grounded floor. This was first investigated with ellipsoids and recently refined with newly available human models (e.g. [Dimbylow, 2007a](#); [Conil et al., 2008](#); [Kühn et al., 2009b](#)). The typical variation in wbSAR as a function of frequency is shown in Fig. 1.12. The same effects have been investigated for partial-body resonances ([Kühn et al., 2009b](#)). The results of these modelling studies explain the main characteristics

Table 1.8 Depth of penetration of muscle and fat by radiofrequency fields at typical telecommunication frequencies

Frequency (MHz)	Muscle			Fat		
	Relative permittivity	Conductivity (S/m)	Penetration depth (mm)	Relative permittivity	Conductivity (S/m)	Penetration depth ^a (mm)
400	57.13	0.80	52	5.58	0.041	310
900	55.03	0.94	42	5.46	0.051	244
1800	53.55	1.34	29	5.35	0.078	158
2450	52.73	1.74	22	5.28	0.105	116
5200	49.28	4.27	8.8	5.01	0.255	47

^a Penetration depths have been calculated based on the equation given in the Glossary.

MHz, megahertz; mm, millimetre; S/m, siemens per metre

Compiled by the Working Group from *Tissue Properties Database: Dielectric Properties* by IT'IS Foundation: <http://www.itis.ethz.ch/itis-for-health/tissue-properties/database/dielectric-properties/>

of far-field exposures of between 10 MHz and 2 GHz, i.e. a strong dependence on body size and posture, and on polarization.

(c) *Below whole-body and partial-body resonances*

At exposures below the body-resonance frequency, i.e. < 10 MHz, the body can be described as a short poor conductor. The dominant exposures of concern are from near-field sources that generally have strong field gradients. Under these conditions, the energy is capacitively coupled in the case of a dominant electric-field source (dielectric heaters, diathermy applicators, etc.) or inductively coupled in the case of a dominant magnetic-field source (e.g. inductive cooking hobs, anti-theft systems, wireless power transfer systems, MRI, etc.). Strong induced currents are also caused by touching metallic objects such as fences or towers exposed to fields from transmitting antennae (contact currents).

(d) *Above whole-body and partial-body resonances*

At exposures above the body-resonance frequency, i.e. > 2 GHz, the body can be described as a dielectric object that is large with respect to the wavelength and the penetration depth (see [Table 1.8](#)). Therefore, the absorption

is approximately proportional to the exposed surface area of the body ([Gosselin et al., 2011](#)). In this case, the wbSAR is proportional to the largest ratio of body surface and weight ([Kühn, 2009](#)), whereas the RF energy is predominantly absorbed at the body surface.

1.3.4 Dependence on local anatomy

(a) *General*

Local exposure is altered by local anatomy due to inhomogeneity of the body tissues. In particular, local enhancements or hot spots can be expected as a result of impedance matching on layered structures, e.g. skin–fat–muscle layers ([Christ et al., 2006](#)), and due to narrowing cross-sections of highly conductive tissues. An example of the latter is high exposure in the ankles when the body is grounded and the electric-field frequency is in the range of or below body resonance; the ankle consists mostly of low-conductive cartilage and the integrated current is largest close to the feet of the grounded person ([Dimbylow, 2005](#)).

(b) *Mobile phones*

During the last decade, the dosimetric analysis of exposure to radiation from mobile phones has focused on reliable compliance testing of the phones with respect to the limits defined

for psSAR-1 g and psSAR-10 g. The absorption values for different mobile phones are determined in homogeneous head phantoms, i.e. the specific anthropometric mannequin (SAM) in touch and tilted positions. The SAR values for different phone positions have been compared in various anatomical models of the head of adults and children. Reviews of these studies concluded that the psSAR assessed with the SAM is a conservative measure of exposure of both adults and children ([Christ & Kuster, 2005](#); [Martens, 2005](#); [Wiart *et al.*, 2005](#)) and that variations in psSAR among different models can be attributed to individual anatomical differences, but not to age-dependent changes in head size ([Kainz *et al.*, 2005](#)).

The effects of age-dependent changes in tissue conductivity have been studied by several authors in various rodent species ([Thurai *et al.*, 1984, 1985](#); [Peyman *et al.*, 2001](#); [Gabriel, 2005](#); [Schmid & Überbacher, 2005](#)).

[Christ *et al.* \(2010a\)](#) investigated the effect of the anatomical differences on specific tissue exposures in humans. These studies concluded that:

- Exposure of regions inside the brain of young children (e.g. hippocampus, hypothalamus, etc.) can be higher by 1.6–3-fold than that in adults.
- Exposure of the bone marrow in the skull of children can exceed that in adults by a factor of about 10, which is due to the high electric conductivity of this tissue at a young age.
- Exposure of the eyes of children is higher than that of adults. Regarding thermal effects, however, this does not present a problem as exposure to the eyes from mobile phones is very low, i.e. < 10% of the psSAR.
- Because of their different locations relative to the ear, brain regions close to the surface of the skull can exhibit large differences in exposure between adults and children. The cerebellum of children can

show a psSAR that is > 2.5-fold that of the local exposure of the cortex of adults. It should be noted that these differences are strongly dependent on the current distribution in the phone, i.e. on the phone design.

- Tissues or anatomical regions that are located at a comparable distance from the phone in adults and children, e.g. the pineal glands, do not show age-dependent variations in exposure.

1.3.5 Estimation of local tissue temperature based on psSAR

In general, the relationship between tissue temperature and psSAR depends strongly upon blood perfusion of the tissue, which varies across the body. In addition, local hot spots (points of elevated temperature) are influenced by thermal conductivity.

The correlation between psSAR and the increase in temperature for exposures to dipoles and mobile phones operated close to the head has been studied ([Hirata *et al.*, 2003](#); [Fujimoto *et al.*, 2006](#); [Hirata *et al.*, 2006a, b, 2008](#)). The results of these studies show that the correlation for a given frequency and exposure type is often good, but that the scaling factor strongly depends on the frequency, the spatial averaging scheme and mass, the tissue perfusion, and geometrical aspects such as anatomical surface curvature. The correlation between local averaged SAR and temperature elevation is weak when multiple tissues are involved. In the brain, the relationship between psSAR and peak temperature is found to be poor, and the tissue distribution and the exact exposure situation have a strong impact on brain heating, with thermo-physiological tissue properties particularly affecting the temperature increase in the head for a given psSAR ([Samaras *et al.*, 2007](#); [McIntosh & Anderson, 2010](#)).

The temperature increase for multiple anatomical models was estimated over a wide

range of frequencies (0.01–5.6 GHz) for plane waves with different polarization and incident angles. The peak temperature increase for a given psSAR was strongly dependent on anatomy and frequency, with variations of one order of magnitude for the cases investigated ([Bakker et al., 2010](#)).

A comparative analysis of seven publications on the increase in brain temperature during mobile-phone use found a high variation (66% at 1800 MHz) in the peak increase in brain temperature relative to the peak averaged SAR in the head ([Samaras et al., 2007](#)). These results confirm the finding that the peak temperature increase in the brain should therefore be correlated with peak averaged SAR in the brain and not with the peak averaged SAR in the whole head. Generally, this peak temperature increase in the brain is strongly influenced by absorption in the neighbouring tissues, thus tissue distribution in that anatomical region is important (e.g. the impact of the cerebrospinal fluid) ([Hirata et al., 2003](#)).

1.3.6 Dosimetry methods

To demonstrate compliance with safety guidelines, wbSAR and psSAR values are estimated conservatively. In most cases, psSAR values are not correlated with a specific tissue or with typical exposures and, therefore, they can only be used for epidemiological studies when additional assessments and considerations are taken into account.

It is practically impossible to measure EMFs non-invasively or *in vivo*; thus, measurements can only be obtained post mortem. The limitations associated with post-mortem evaluations include: (1) accessibility to certain tissues only; (2) field distortions caused by the invasively introduced probe and dielectric changes due to decreased tissue temperature and blood content; and (3) large uncertainties associated with obtaining accurate measurements near and

across tissue boundaries. Only the integrated, total absorbed power can be determined relatively easily by means of the calorimetric method (see Section 1.4.4).

Progress in computational electromagnetics and the exponential growth of computational power and computer memory have facilitated the determination of field distributions in full anatomical models of human bodies with resolutions much smaller than 1 mm³. The dissipative properties and the low quality-factor of complex anatomical structures pose no special problem for numerical analyses such as the finite-difference time-domain (FDTD) method. A grid resolution of less than 0.2 mm in a specific region of the body and of 0.5–1 mm for uniform resolution is the standard for today's FDTD computations. Finite-element methods (FEM) are also increasingly used, especially for evaluation of exposures below 10 MHz. Approaches such as the combination of the method of moment (MoM) with FDTD, are also regularly applied ([Meyer et al., 2003](#)).

Numerical techniques have also become more powerful with the availability of human models that will soon represent the full range of anatomical variation within the human population. Reviews of these models are available ([Dimbylow et al., 2009](#); [Christ et al., 2010b](#); [Wu et al., 2011](#)). In some of these models, body posture can be varied. These models are applied to assess typical exposures, to determine interaction mechanisms, and to derive simplified phantoms for compliance testing.

(a) *Methods to demonstrate compliance with guidelines*

For compliance testing of commercial mobile telecommunication devices that operate very close to the human body, experimental dosimetry is often superior to numerical approaches. The measurement instruments and methods are described in Section 1.4. The sources usually consist of highly resonant components assembled

Fig. 1.13 Estimated tissue-averaged specific absorption rate (stSAR) of the thalamus, temporal lobe and cortex of the brain, induced by various transmission sources

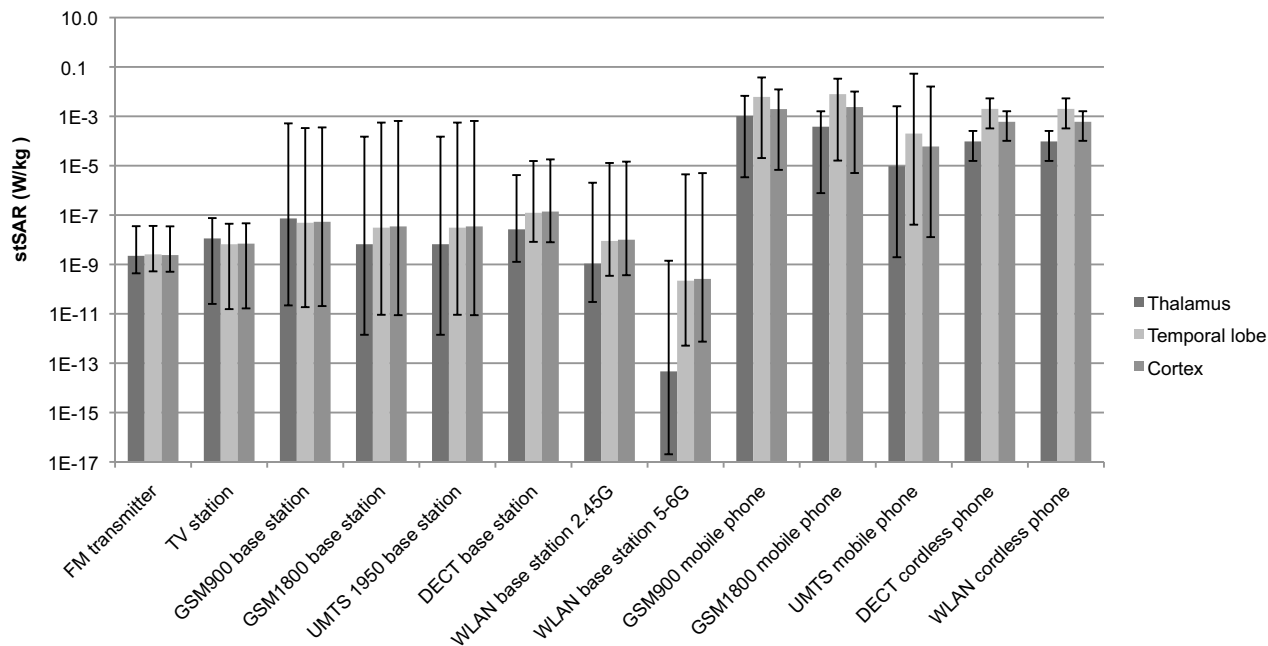

Produced by the Working Group from [Kühn et al. \(2010\)](#)

with other electronic and metallic structures. It is difficult to use simulations to predict with certainty if and how secondary resonant structures may be excited, especially in view of the effect of the reflected field of biological bodies on the performance of the device. Small spatial differences can easily result in deviations of more than a factor of two from the actual value. Only when the structure is electromagnetically well defined can a good agreement between simulation and measurement be achieved, i.e. with deviations of less than 20% ([Chavannes et al., 2003](#)). It should be noted that detailed information about field distributions inside anatomical bodies is often irrelevant because it cannot be generalized and because differences in anatomy and posture can result in significantly different SAR distributions. However, for safety reasons, the upper boundary (typically the 95th percentile) of the exposure for the entire population is relevant, rather than individual exposure levels. Hence, worst-case phantoms, derived by means

of the numerical methods mentioned above, are often applied to assess the upper exposure limits for specific exposure conditions, e.g. during the use of mobile-phone handsets.

(b) Methods to estimate typical exposures

Estimation of typical exposures for specific tissues requires the numerical evaluation of the user's anatomy and usage pattern for the average output power, including its variations. Procedures to make such estimations for different brain regions exposed to mobile-phone radiation have recently been developed ([Gosselin et al., 2011](#)). Similar procedures can be applied for other sources. Quantitative estimates are given in Fig. 1.13, which illustrates the estimated tissue-averaged SARs for the thalamus, temporal lobe and cortex when induced by various transmission sources. The typical minimal and maximal values are also given. The basis for these values is shown in [Table 1.9](#). The largest exposure is

Table 1.9 Estimated minimum, maximum and average exposures in the brain from various sources of radiofrequency radiation

Source	Frequency (MHz)	Exposure			
		Average	Minimum	Maximum	Unit
FM transmitter	100	0.02	0.01	0.07	V/m
TV station	700	0.02	0.001	0.05	V/m
GSM900 base station	950	0.05	0.001	4	V/m
GSM1800 base station	1850	0.05	0.001	6	V/m
DECT base station	1890	0.1	0.03	1	V/m
UMTS 1950 base station	2140	0.05	0.001	6	V/m
WLAN base station	2450	0.03	0.007	1	V/m
WLAN base station	5200/5800	0.01	0.001	1	V/m
GSM900 mobile phone	900	50	0.2	250	mW
GSM1800 mobile phone	1750	40	0.1	125	mW
DECT cordless phone	1890	10	3	20	mW
UMTS mobile phone	1950	1	0.0003	200	mW
WLAN cordless phone	2450	10	3	20	mW

Note: Far-field exposures are estimated in terms of incident-field values and exposures from handsets are calculated from time-averaged output power.

Compiled and calculated by the Working Group from [Kühn et al. \(2010\)](#)

caused by the GSM mobile telephone, followed by exposures from DECT and WLAN cordless handsets. The new wideband code-division multiple access (WCDMA) systems result in much lower exposure values. It should be noted that the maximum exposure level is very similar for all mobile handsets. The averaged induced fields in the brain resulting from exposure to electromagnetic radiation from base stations of any technology are more than four orders of magnitude lower than those from a handset.

1.3.7 Exposure set-ups for laboratory studies

Properly designed laboratory exposure set-ups with sensitive monitoring systems are critical for producing reliable and reproducible results on the potential health effects of RF radiation. The selection of an exposure set-up is intimately linked to the design and objectives of the study, and includes factors such as the efficiency of the coupling of the incident field with the biological system, the number of animals or cell-culture samples needed per exposure level

for statistical analyses, the daily exposure times, and the overall duration of the study. Examples of exposure systems used for this type of study include:

- *Far-field/anechoic chamber*: a room designed to minimize reflections of either sound or electromagnetic waves. To prevent the latter, the inner walls of the chamber are covered with pyramid-shaped RF radiation-absorbent material ([Chou & Guy, 1982](#)). Animals or tissue-culture dishes are exposed to RF radiation via an antenna (e.g. horn antenna).
- *Near-field systems*: antennae are used to obtain partial body exposures. In the Carousel system, the animals in restraining tubes are oriented radially around a central antenna at a fixed distance between the nose of the animal and the antenna ([Adey et al., 1999](#)). Loop antennae have been used to predominantly expose a particular part of the brain ([Lévêque et al., 2004](#)).

- *Transverse electromagnetic (TEM) cell*: an RF-shielded box in which tissue cultures are positioned with a defined orientation relative to the direction of wave propagation and the electric field. A rectangular coaxial transmission line tapered at both ends provides a uniform incident plane wave when RF energy is coupled to the line ([Crawford, 1974](#)). Studies with cell cultures and animal models have been conducted in various modified TEM cells ([Nikoloski et al., 2005](#)).
- *Waveguide*: a structure that guides and confines electromagnetic waves to propagation in one dimension within a round or rectangular metallic tube. Waveguides have the advantage that only the fundamental mode can propagate within a certain frequency band, correlated with its dimensions. Therefore, resonant systems can be easily used. The power losses of the propagating wave must be carefully evaluated if larger objects are exposed. Standing waves must be appropriately used in case of resonant waveguides or waveguides terminated by a short circuit. Waveguides are widely used for *in-vitro* systems (e.g. [Schuderer et al., 2004b](#)). Non-resonant waveguides have also been used to expose rodents (e.g. [Guy et al., 1979](#)) and a cascade of 17 sectorial resonant waveguides excited by one quad-loop antenna have been employed to expose one rat per waveguide ([Kainz et al., 2006](#)).
- *Radial transmission line (RTL)*: a structure that confines the wave to propagate in two dimensions with two parallel metal plates excited between their centres by an antenna. In the case of a non-resonant application, the wave is terminated at the perimeter of the lateral plates with absorbers ([Hansen et al., 1999](#); [Moros et al., 1999](#)). The system has been used for studies *in vivo* or *in vitro* by placing the

cell cultures or animals at a fixed distance from the antenna. RTL has also been used as a resonant structure in which the wave is terminated with metallic rods instead of absorbers. This configuration has also been called a “Ferris wheel,” whereby the animals in restraining tubes are positioned at a fixed distance to the reflecting rods ([Balzano et al., 2000](#)). Several improvements have been suggested and implemented ([Ebert, 2009](#)).

- *Reverberation chamber*: a shielded room with minimal absorption of electromagnetic energy. To create statistically homogeneous fields inside the chamber when exposure is averaged over time, rotating metallic reflectors (stirrers) constantly create changing boundary conditions. Animals are unrestrained during exposure ([Jung et al., 2008](#)).

Regardless of the type of exposure system, for a correct interpretation of the findings and replication of the experiments in other laboratories, it is important that all pertinent electromagnetic-field exposure characteristics (particularly dosimetry) and biological parameters be fully addressed in the experimental design, and properly described in the study reports ([Valberg, 1995](#); [Kuster & Schönborn, 2000](#); [Kuster et al., 2006](#); [Belyaev, 2010](#)). These factors are briefly discussed in the next two sections.

1.3.8 Exposure characterization in laboratory studies

The experimental conditions during studies on the effects of exposure to EMF should be described in detail as listed below:

- Signal characteristics should include: carrier frequency, modulation scheme, power level and stability;
- Zone of exposure (near field or far field);

- Polarization (e.g. linear or circular polarization) of the induced EMF with respect to the biological system;
- Performance of the setup: determination of induced electric- and magnetic-field strengths and SAR levels and distribution (numerical dosimetry) in the cell culture, or per organ site in animal experiments; this part should also include an uncertainty analysis;
- Field distribution: should be homogeneous ($SD < 30\%$ in cell cultures) and variations in the exposure levels of individual tissues of the exposed animals should be characterized, including details on animal age, movement, posture, weight, etc.;
- The increase in temperature caused by the RF field must be well characterized and reported;
- Control of acoustic noise/vibration level and exposure to ambient RF fields and static fields;
- Monitoring: should include verification of incident field strengths and homogeneity, induced fields, and any changes in the performance of elements of the exposure system over the duration of the experiment, including the long-term reliability of monitoring equipment;
- Experimental design requirements: duration of exposure (hours per day and total number of days), continuous or intermittent (on/off cycles), time of day;
- Inclusion of a sham-exposure group.

1.3.9 Biological factors in studies in experimental animals

The biological factors that may affect the study results are briefly described below:

(a) *Studies in vivo*

- Identification and justification of the selected animal model (species, strain, sex, age at start and end of study, genotype and phenotype, exposure to other agents);
- Animal husbandry: diet (ingredients, nutrient composition and contaminant levels), drinking-water source and treatment, availability or restriction of feed and water during exposures, absence of specific pathogens, caging (cage material, number of animals per cage, bedding material), prevention of exposure to electric currents from water supply, absence/presence of animal restraining devices;
- Environmental controls: temperature, relative humidity, lighting (on/off cycle, intensity), airflow, noise, and background fields;
- Characterization of animal weight, positioning/orientation, movement in the exposure system, and proximity of other animals and cage boundaries during exposure periods.

(b) *Studies in vitro*

- Composition of the incubation media, including antioxidant levels, free-radical scavengers, presence of magnetic particles;
- Source and/or derivation of the cell system and its characteristics: cell type, species, strain, sex, age, genotype and phenotype;
- Quality of the cell-culture system and its functional condition: cell viability, growth phase and cell-cycling rate, metabolic status, and cell density (which may affect cell-cell interactions);
- Size, shape, and position of the cell-culture vessel;
- Environmental controls, including temperature, oxygen/carbon dioxide levels, air flow.

Table 1.10 Summary of studies on models of partial body exposure

Reference	Description of the model	Main results and comments
Gandhi <i>et al.</i> (1999)	EM absorption in the head and neck region	A FDTD method and a new phantom model of the human body at millimetre resolution were used to study EM energy coupled to the head from mobile phones at 835 and 1900 MHz. Homogeneous models are shown to grossly overestimate both the peak 1-voxel and 1-g SARs. It is possible to use truncated one-half or one-third models of the human head with negligible errors in the calculated SAR distributions.
Hombach <i>et al.</i> (1996)	EM energy absorption upon modelling of the human head at 900 MHz	Dependence on anatomy and modelling in the human head were investigated for EM energy absorption at 900 MHz from RF sources operating very close to the head. Different head phantoms based on MRI scans of three adults were used with voxel sizes down to 1 mm ³ . The phantoms differ greatly in terms of shape, size, and internal anatomy. The results demonstrate that size and shape are of minor importance. The volume-averaged psSAR obtained with the homogeneous phantoms only slightly overestimates that of the worst-case exposure in the inhomogeneous phantoms.
Schönborn <i>et al.</i> (1998)	Energy absorption in the head of adults and children	The levels of EM energy absorbed at 835 MHz and 1900 MHz in the heads of mobile-phone users were compared for adults and children. No significant differences between adults and children were found in the absorption of EM radiation in the near field of sources. The same conclusion holds when children are approximated as scaled adults.
Bit-Babik <i>et al.</i> (2005)	Estimation of SAR in the head of adults and children	The peak local average SAR over 1 g and 10 g of tissue and the EM energy penetration depths are about the same in all of the head models under the same exposure conditions.
Wang & Fujiwara (2003)	Evaluation of EM absorption in head models of adults and children	Based on statistical data on external shape of the head in Japanese children, two models were developed to assess SAR values in the head of a child exposed to RF radiation. Compared with the local peak SAR in the model of the adult head, there was a considerable increase in the child's head when the output power of the monopole-type antenna was fixed, but no significant difference when the effective current of the dipole-type antenna was fixed.
Anderson (2003)	Peak SAR levels in head models of children and adults	Multipole analysis of a three-layered (scalp/cranium/brain) spherical head model exposed to a nearby 0.4-lambda dipole at 900 MHz was used to assess differences in SAR in the brain of adults and children. Compared with an average adult, the peak SAR-10 g in the brain of children with a mean age of 4, 8, 12 or 16 yr is increased by a factor of 1.31, 1.23, 1.15 and 1.07, respectively. The maximum rise in brain temperature is about 0.14 °C for an average child aged 4 yr, i.e. well within safe levels and normal physiological parameters.
Martínez-Búrdalo <i>et al.</i> (2004)	Peak SAR levels in head models of adults and children	The FDTD method was used to assess differences in SAR in the brain of adults and children, at 900 and 1800 MHz. Peak SAR-1 g and peak SAR-10 g all decrease with decreasing head size, but the percentage of energy absorbed in the brain increases.
Fernández <i>et al.</i> (2005)	EM absorption in head models of adults and children	The peak SAR in the head model for a child aged 10 yr was 27% higher than that in the phantom of an adult head, when dielectric properties of a child's tissue were applied, based on fitted parameters. For the peak SAR-10 g, an increase of 32.5% was observed.
Keshvari & Lang (2005)	RF energy absorption in the ear and eye of children and adults	The FDTD computational method was used to calculate a set of SARs in the ear and eye region for anatomically correct head models for adults and children. A half-wave dipole was used as an exposure source at 900, 1800 and 2450 MHz. The head models were greatly different in terms of size, external shape and internal anatomy. The SAR difference between adults and children is more likely to be caused by general differences in the head anatomy and geometry of the individuals rather than by age.
Christ & Kuster (2005)	RF energy absorption in the head of adults and children	The conclusions of this review do not support the assumption that energy exposure to children is increased due to smaller size of the head compared with adults, but points at dielectric tissue parameters and the thickness of the pinna (the external part of the ear) as factors that determine RF energy absorption.

Table 1.10 (continued)

Reference	Description of the model	Main results and comments
Hadjem <i>et al.</i> (2005a)	SAR induced in models of the head of children and adults	The FDTD computational method was used to calculate SARs for two child-size head models and two adult-size head models, with a dual-band mobile phone. No important difference was observed in the peak SAR-10 g between the two adult models, or between the two child models.
Hadjem <i>et al.</i> (2005b)	Ear morphology and SAR induced in a child's head	Using the FDTD method, SARs induced in the heads of children aged 12 yr were calculated for different ear dimensions, at 900 and 1800 MHz. Exposure to the brain was dependent on the morphology of the ear.
Wiarł <i>et al.</i> (2005)	Modelling of RF exposure in a child's head	Parameters that influence the SAR in children's heads, such as the evolution of head shape and the growth of, e.g. skull thickness, were analysed. The SAR-1 g in specific tissue was assessed in different models of a child's head based on MRI and on non-uniformly down-scaled adult heads. A handset with a patch antenna operating at 900 MHz was used as the exposure source.
Kainz <i>et al.</i> (2005)	Dosimetric comparison of SAM to anatomical models of the head	The SAM was used to estimate exposure in anatomically correct head models for head-only tissue. Frequency, phone position and head size influence the calculated SAR-10 g, which in the pinna can be up to 2.1 times greater than the psSAR.
de Salles <i>et al.</i> (2006)	Absorption of RF radiation in the head of adults and children	The SAR produced by mobile phones in the head of adults and children was simulated with an FDTD-derived algorithm, with EM parameters fitted to realistic models of the head of a child and an adult. Microstrip or patch antennae and quarter-wavelength monopole antennae were used at 1850 and 850 MHz. Under similar conditions, the SAR-1 g calculated for children is higher than that for adults. In the model of a child aged 10 yr, SAR values > 60% of those for adults are obtained.
Joó <i>et al.</i> (2006)	Metal-framed spectacles and implants and SAR in models of the heads of adults and children	The SAR from mobile telephones in the head of adults and children wearing metal-rim spectacles and having metallic implants was calculated by the FDTD method, and compared with the ANSI/IEEE standards and with the EU standard limits for radiation at 900/1800/2100 MHz. A maximum of the SAR in the child's head was found, which in children with metallic implants could be as much as 100% higher than in the adult head. In the case of exposure at 2100 MHz with vertical position of the phone for adults and at 900 MHz for children with metallic implants, the ANSI/IEEE limits were exceeded.
Fujimoto <i>et al.</i> (2006)	Temperature increase and peak SAR in head models for children and adults	The correlation between peak SAR and rise in temperature was studied in head models of adults and children exposed to radiation from a dipole antenna. The maximum rise in temperature can be estimated linearly in terms of peak SAR-1 g or peak SAR-10 g of tissue. No clear difference was observed between adults and children in terms of the slopes correlating the maximum rise in temperature with the peak SAR. The effect of electrical and thermal constants of the tissue on this correlation was marginal.
Beard <i>et al.</i> (2006)	SAR comparison between SAM phantom and human head models	The SAM was used to calculate the SAR of the pinna, separately from that of the head. In this case, the SAR found in the head was higher than that found with anatomically correct head models. The peak SAR-1 g or SAR-10 g was statistically significantly higher in the larger (adult) head than in the smaller (child) head for all conditions of frequency and position.
Lee <i>et al.</i> (2007)	Changes of SAR in head models by age	Four head models, representing different ages, were used to calculate SARs from exposure to three bar-type phones, according to positioning against the ear. Input resistance of the phone antennae in the cheek position increased when head size grew with age, but for the tilt position this value showed a slight decrease. For a fixed input power, the head models by age showed a 15% change in peak SAR-1 g and peak SAR-10 g. For a fixed radiated power, the peak SARs diminished in the smaller head model and were higher in the larger model, compared with those for the fixed input power. A simultaneous change (up to 20–30%) in the conductivity and permittivity of head tissue had no effect on energy absorption.

Table 1.10 (continued)

Reference	Description of the model	Main results and comments
Wuart <i>et al.</i> (2007, 2008)	RF exposure assessment in children head	RF exposure in the head tissues of children was analysed with phantom models and with a dipole and a generic handset at 900, 1800, 2100 and 2400 MHz. The SAR-10 g in the head was studied in heterogeneous head models (seven for children, six for adults). The maximum SAR-10 g estimated in the head models of adults and children were small compared with the SDs. However, the maximum SAR-1 g in peripheral brain tissues of the child models (age, 5–8 yr) is about twice that in adult models, which is not seen with head models for children older than 8 yr. The differences can be explained by the lower thicknesses of pinna, skin and skull of the models for the younger child.
Christ <i>et al.</i> (2007)	The exposure of the human body to fields from wireless body-mounted or hand-held devices	A generic body model and simulations of anatomical models were used to evaluate the worst-case tissue composition with respect to the absorption of EM energy from wireless body-mounted or hand-held devices. Standing-wave effects and enhanced coupling of reactive near-field components can lead to an increased SAR compared with homogeneous tissue. With respect to compliance testing, the increased SAR may require the introduction of a multiplication factor for the psSAR measured in the liquid-filled phantom to obtain a conservative exposure assessment. The observed tissue heating at the body surface under adiabatic conditions can be significant, whereas the rise in temperature in the inner organs is negligible.
Christ <i>et al.</i> (2010b)	RF absorption in the heads of adult and juvenile mobile-phone users	The external ear (pinna) is the spacer between the top of a phone and the head tissue. Variations of this distance as a function of age, the mechanical force on the pinna, and how it affects the psSAR were investigated among adults and children (age, 6–8 yr) while applying a defined force on the ear. The average distances were 10.5 ± 2.0 (SD) mm for children (age, 6–8 yr) and 9.5 ± 2.0 (SD) mm for adults. The pinnae of three anatomical high-resolution head models (one adult, two child) were transformed accordingly. Numerical exposure analysis showed that the reduced distance due to compression of the pinna can increase the maximum psSAR by approximately 2 dB for adults and children, if the exposure maximum is associated with the upper part of the phone.
Lee & Yun (2011)	Comparison of SARs for the SAM phantom and head models for children	SARs in three head models for children (Korean aged 7 yr; European aged 5 or 9yr) were compared with those of the SAM phantom for exposure at 835 and 1900 MHz. Compression of the pinnae, different positions of the earpiece against the ear entrance canal, different skin and fat properties, and different internal fat and muscle morphologies in the tissue near the phone, were analysed. A phone with a monopole antenna was used for the calculation at each frequency. Results show that a compressed pinna did change the SAR values at 835 MHz, but at 1900 MHz there was an average 25–29% increase in SAR-10 g for pinna-excluded and pinna-included tissue. The peak SAR-10 g was very sensitive to subcutaneous fat and muscle structure when touched by the mobile phone; a muscle-dominant internal head structure led to a higher peak SAR-10 g. The SAM phantom does not seem to provide a conservative estimation of exposure of children's heads at 1900 MHz.

ANSI, American National Standards Institute; EM, electromagnetic; EU, European Union; FDTD, finite-difference time-domain; IEEE, Institute of Electrical and Electronic Engineers; MRI, magnetic resonance imaging; psSAR, peak spatial SAR; RF, radiofrequency; SAM, specific anthropomorphic mannequin; SAR, specific absorption rate; SD, standard deviation; yr, year or years

Table 1.11 Summary of studies on models of whole-body exposure

Reference	Description of the model	Main results and comments
Dimbylow (1997)	Calculation of whole-body-averaged SAR in a voxel model	FDTD calculations were made of the whole-body-averaged SAR in an anatomically realistic voxel model of the human body, which consists of approximately 9 million voxels segmented into 37 tissue types. SAR values are presented for an adult phantom and for scaled models of children aged 10, 5 or 1 yr, grounded and isolated in air from 1 MHz to 1 GHz for plane-wave exposure. External electric-field values corresponding to a whole-body-averaged SAR of 0.4 W/kg are also presented.
Tinniswood et al. (1998)	Calculation of power deposition in the head and the neck for plane-wave exposures	When the human head becomes a resonant structure at certain frequencies, the power absorbed by the head and neck becomes significantly larger than would normally be expected from its shadow cross-section. Resonant frequencies were 207 MHz and 193 MHz for the isolated and grounded conditions, with absorption cross-sections that are respectively 3.27 and 2.62 times the shadow cross-section.
Hurt et al. (2000)	Effects of variation in permittivity on SAR calculations	The authors studied the effect of variation in permittivity values on SAR calculations. Whole-sphere averaged and localized SAR values along the diameter of a 4-cm sphere were calculated for exposures of 1 MHz to 1 GHz. When the sphere is small compared with the wavelength, the whole-sphere averaged SAR is inversely proportional to the permittivity of the material composing the sphere, but the localized SAR values vary greatly depending on the location within the sphere.
Dimbylow (2002)	Calculation of SAR up to 3 GHz	FDTD calculations of whole-body-averaged SAR values were made for frequencies from 100 MHz to 3 GHz at 2-mm resolution without any rescaling to larger cell sizes. The small voxel size allows SAR to be calculated at higher frequencies. In addition, the calculations were extended down to 10 MHz, covering whole-body resonance regions at 4-mm resolution. SAR values were also calculated for scaled versions representing children aged 10, 5 or 1 yr for both grounded and isolated conditions.
Bernardi et al. (2003)	SAR and rise in temperature in the far field of RF sources at 10–900 MHz	The EMF inside an anatomical heterogeneous model of the human body exposed at 10–900 MHz was computed with the FDTD method; the corresponding increase in temperature was also evaluated. The thermal model took account of the thermoregulatory system of the human body. Compared with the whole-body averaged SAR, the SAR-10 g shows an increase of 25-fold in the trunk and 50-fold in the limbs, whereas the peak SAR-1 g shows an increase of 30–60-fold in the trunk, and up to 135-fold in the ankles.
Findlay & Dimbylow (2005)	Effects of posture on SAR	A change in posture can significantly affect the way in which the human body absorbs RF EM radiation. The FDTD method was used to calculate the whole-body-averaged SAR at frequencies from 10 MHz to 300 MHz at a resolution of 4 mm. Raising an arm above the head increased the SAR value at resonance by up to 35% compared with the standard, arms-by-the-side position.
Wang et al. (2006)	Whole-body averaged SAR in adult and child models	Due to the difficulty of measuring SAR in an actual human body exposed to RF-EMF, the incident electric field or power density is often used as a reference. In verifying the validity of the reference level, it is essential to have accurate modelling for humans. A detailed error analysis in the whole-body-averaged SAR calculation was done with the FDTD method in conjunction with the perfectly matched layer (PML) absorbing boundaries. To clarify whole-body-averaged SAR values, a Japanese adult model and a scaled child model were used. The whole-body-averaged SAR under the reference level exceeded the basic safety limit by nearly 30% for the child model, both in the resonance frequency and in the band 2 GHz.
Dimbylow (2007a)	SAR values in voxel models of mother and fetus	An FDTD calculation was conducted of SAR values (20 MHz to 3 GHz) in hybrid voxel-mathematical models of the pregnant female. Models of the developing fetus at 8, 13, 26 and 38 wk of gestation were converted into voxels and combined with the adult female model, at a resolution of 2 mm. Whole-body-averaged SAR in the mother, the average SAR over the fetus, over the fetal brain, and in 10 g of the fetus were calculated.

Table 1.11 (continued)

Reference	Description of the model	Main results and comments
Dimbylow & Bolch (2007b)	Whole-body-averaged SAR in voxel phantoms for a child	Five paediatric phantoms (representing boys aged 9 months, 11 yr and 14 yr, and girls aged 4 and 8 yr) were adapted to calculate the whole-body-averaged SARs in children for plane-wave exposure from 50 MHz to 4 GHz. A comparison was made with previous linearly scaled versions, at a resolution of 2 mm. Further FDTD calculations were performed at resolutions of 1 and 0.7 mm above 900 MHz, to elucidate the effects of variation in grid resolution.
Hirata <i>et al.</i> (2003)	Temperature increase in head and brain	The temperature increase (ΔT) in a human head exposed to EM waves (900 MHz to 2.45 GHz) from a dipole antenna was investigated. The maximum ΔT in the head and brain was compared with values from the literature of 10 °C and 3.5 °C for microwave-induced physiological damage. The SAR in the head model was initially calculated by the FDTD method. The ΔT distribution in the head is largely dependent on the frequency of the EM waves, and the maximum ΔT values in the head and brain are significantly affected by the frequency and polarization of the waves. The maximum ΔT in the head (excluding auricles) and brain are determined through linear extrapolation of the peak average SAR in these regions. The peak SAR-1 g should be approximately 65 W/kg to achieve a maximum ΔT of 10 °C in the head, excluding auricles.
Vermeeren <i>et al.</i> (2008)	Statistical method to calculate absorption of RF energy	Quantifying the absorption of EM radiation in a human body in a realistic, multipath exposure environment requires a statistical approach, because it needs to be determined for several thousands of possible exposures. To avoid having to make this large number of time-consuming calculations with the FDTD method, a fast numerical method was developed to determine the whole-body absorption in a spheroid human-body model in a realistic exposure environment. This method uses field distributions of a limited set of incident plane waves to rapidly calculate whole-body absorption for any single or multiple plane-wave exposure. This fast method has now been extended to realistic heterogeneous human-body models.
Nagaoka <i>et al.</i> (2007)	SAR of a whole-body phantom for pregnant women	A new model for the fetus, including inherent tissues of pregnant women, was constructed on the basis of abdominal MRI data for a woman at week 26 of pregnancy. A whole-body pregnant-woman model was developed by combining the fetus model with a nonpregnant-woman model, developed previously. The model consists of about 7 million cubical voxels (size, 2 mm) and is segmented into 56 tissues and organs. The basic SAR characteristics are presented of the pregnant-woman model exposed to vertically and horizontally polarized EM waves from 10 MHz to 2 GHz.
Nagaoka <i>et al.</i> (2008)	SAR for a phantom model of Japanese children	An existing voxel model of a Japanese adult in combination with 3D deformation was used to develop three voxel models that match the average body proportions of Japanese children at age 3, 5 and 7 yr. The models consist of cubic voxels (size, 2 mm) and are segmented into 51 tissues and organs. Whole-body-averaged SARs and tissue-averaged SARs were calculated for the child models, for exposures to plane waves from 30 MHz to 3 GHz.
Togashi <i>et al.</i> (2008)	SAR for the fetus in a pregnant-woman model	Dosimetry of EM radiation is described in a pregnant woman in the proximity of a mobile-phone terminal by use of the numerical model of a woman in the seventh month of pregnancy. The model is based on the high-resolution whole-body voxel model of a Japanese adult woman. It is composed of 56 organs, which include the intrinsic organs of a pregnant woman.

Table 1.11 (continued)

Reference	Description of the model	Main results and comments
Conil <i>et al.</i> (2008)	SAR for different adult and child models using the FDTD method	Six adult anthropomorphic voxel models were collected and used to build models for children aged 5, 8 and 12 yr, with a morphing method that respects anatomical parameters. FDTD calculations of SARs were performed for frequencies from 20 MHz to 2.4 GHz for isolated models exposed to plane waves. A whole-body-averaged SAR, average SARs on specific tissues such as skin, muscles, fat or bones, and the average SAR on specific parts of the body such as head, legs, arms or torso, were calculated. The SD of the whole-body-averaged SAR of adult models can reach 40%. For adults, compliance with reference levels ensures compliance with basic restrictions. For children, the whole-body-averaged SAR exceeds the fundamental safety limits by up to 40%.
Kühn <i>et al.</i> (2009b)	Assessment of induced EMFs in various human models	The absorption characteristics are given for various anatomies ranging from a child aged 6 yr to a large adult male, by numerical modelling, with exposure to plane waves incident from all six major sides of the humans with two orthogonal polarizations each. Worst-case scattered-field exposure scenarios were constructed to test the implemented procedures of current in situ compliance measurement standards. The results suggest that the reference levels of current EM safety guidelines for demonstrating compliance, as well as some of the current measurement standards, are not consistent with the basic restrictions and need to be revised.
Neubauer <i>et al.</i> (2009)	SAR and EMF intensity for heterogeneous exposure	The relation between the incident EMF strength, the wbSAR, and the local SAR, was investigated for heterogeneous exposure scenarios at mobile communication frequencies. For whole-body exposure at 946 MHz, 12% of all heterogeneous cases examined represent worse exposure conditions than plane-wave exposure. This percentage increases to 15% at 1840 MHz, and to 22% at 2140 MHz. The results indicate the need to extend investigations to numerical simulations with additional human phantoms representing parts of the human population having different anatomy and morphology compared with the phantom used here. This also applies to phantoms of children.
Hirata <i>et al.</i> (2009)	Whole-body-averaged SAR in children	The whole-body-averaged SAR was calculated in an infant model with the FDTD method, and the effect of polarization of incident EM waves on this SAR was investigated. The whole-body-averaged SAR for plane-wave exposure with a vertically aligned electric field is smaller than that with a horizontally aligned electric field for frequencies above 2 GHz. The main reason for this difference is probably the component of the surface area perpendicular to the electric field of the incident wave.
Nagaoka & Watanabe (2009)	Estimation of SAR in different models for children	To estimate individual variability in SAR for children of different age and with different physical features, a large set of 3D body-shape data from actual children aged 3 yr was used to develop several homogeneous models of these children. The variability in SAR of these models of whole-body exposure to RF-EMF in the VHF band was calculated by the FDTD method.
Findlay <i>et al.</i> (2009)	SAR for voxel models for children in different postures	SAR calculations were performed on two voxel models (NORMAN, ETRI) for a child aged 7 yr in different postures (standing with arms down, standing with arms up, sitting) for plane-wave exposure under isolated and grounded conditions between 10 MHz and 3 GHz. There was little difference at each resonant frequency between the whole-body-averaged SARs calculated for the two models for each of the postures studied. However, compared with the arms-down posture, raising the arms increased the SAR by up to 25%.

Table 1.11 (continued)

Reference	Description of the model	Main results and comments
Kühn <i>et al.</i> (2009b)	SAR induced in the human head from mobile phones used with hands-free kits	To determine the extent to which the use of wired and wireless hands-free kits can reduce human exposure, the SARs from these kits were determined experimentally while connected to mobile phones (GSM900/1800, UMTS1950) under maximized current coupling onto the cable and various wire-routing configurations. The maximum psSAR in the head when using wired hands-free kits was more than five times lower than current recommended limits. The SAR in the head depends on the output power of the mobile phone, the coupling between the antenna and cable, external attenuation and potential cable-specific attenuation. In general, a wired hands-free kit considerably reduces the exposure of the entire head region compared with mobile phones operated at the head.
Gosselin <i>et al.</i> (2009)	Human exposure in the close vicinity of mobile-phone base-station antennae	Human exposure in close vicinity of mobile-phone base-station antennae was assessed by means of FDTD simulations. The peak spatial average SAR and the whole-body-averaged SAR were calculated for three different anatomical models (55–101 kg) at distances between 0.5 and 4 m from various antenna types, at frequencies of 450–2140 MHz. The whole-body absorption generally determines the maximum permissible output power for collinear array antennae. In particular for short antennae, the peak spatial average SAR can be more restrictive than the whole-body absorption because they may only expose a fraction of the body.
Vermeeren <i>et al.</i> (2010)	SARs in a phantom for a human male exposed to representative base-station antennae	The variation in whole-body and peak spatially averaged SARs was determined for the heterogeneous “virtual family” male model placed at 30 cm, 1 m, 3 m and 10 m in front of different base-station antennae in a reflective environment. SAR values were also compared with those in the free-space situation. The six base-station antennae operated at 300 MHz, 450 MHz, 900 MHz, 2.1 GHz, 3.5 GHz and 5.0 GHz, respectively. The ratio of the SAR in a reflective environment and the SAR in the free-space environment ranged from –8.7 dB up to 8.0 dB.
Uusitupa <i>et al.</i> (2010)	SAR variation for 15 voxel models including different postures	A study on SARs covering 720 simulations and 15 voxel models (body weight range, 18–105 kg) was performed by applying the parallel FDTD method. The models were irradiated with plane waves (300 MHz to 5 GHz) with various incoming directions and polarizations. For an adult, the effect of incoming direction on wbSAR is larger in the GHz range than at around 300–450 MHz, and the effect is stronger with vertical polarization. For a child (height, ~1.2 m), the effect of incoming direction is similar as for an adult, except at 300 MHz for horizontal polarization. Body posture has little effect on wbSAR in the GHz range, but at around 300–450 MHz, a rise of 2 dB in wbSAR may occur when posture is changed from the standing position. Between 2 and 5 GHz for adults, wbSAR is higher for horizontal than for vertical polarization. In the GHz range, horizontal polarization gives higher wbSAR, especially for irradiation from the lateral direction. A homogenized model underestimates wbSAR, especially at approximately 2 GHz.
Kawai <i>et al.</i> (2010)	Computational dosimetry of SAR in models of embryos of different age	SAR dosimetry is presented in models of pregnant (4 and 8 wk) Japanese women, with a cubic (4 wk) or spheroidal (8 wk) embryo, exposed to plane waves at frequencies of 10 MHz to 1.5 GHz. The averaged SARs were calculated in the embryos exposed to vertically and horizontally polarized plane waves. The maximum average SAR in the exposed embryos is < 0.08 W/kg when the incident power density is at the recommended environmental level for the general public.

3D, three-dimensional; ANSI, American National Standards Institute; EMF, electromagnetic field; EU, European Union; FDTD, finite-difference time-domain; IEEE, Institute of Electrical and Electronic Engineers; mo, month or months; MRI, magnetic resonance imaging; psSAR, peak spatial SAR; PML, perfectly matched layer; RF, radiofrequency; SAM, specific anthropomorphic mannequin; SAR, specific absorption rate; sSAR, spatially averaged SAR; SD, standard deviation; VHF, very high frequency; wbSAR, whole-body SAR; wk, week or weeks; yr, year or years

For a summary of studies with models for partial- or whole-body exposure, see [Tables 1.10](#) and [1.11](#).

1.4 Measurement techniques

1.4.1 Introduction

Assessment of the incident exposure is simple for plane-wave or far-field conditions. Unfortunately, when high exposures are involved, far-field conditions rarely occur, due to the proximity of the source. In addition, the reflecting environments result in fading, producing fields that are highly variable spatially and temporally.

In general, far-field conditions are approximately met locally by changing the amplitude in space at distances larger than the extension of the reactive near-field zone ([CENELEC, 2008](#)):

Thus, for distances meeting the requirements of the equation, only the maximum of the field components must be determined to demonstrate compliance. For any distance smaller than the requirements of the equation, the maximum of both components must be spatially scanned to reliably predict that the maximal induced fields are below a certain limit. Fine volume scanning of transmitting antennae in the very near field yields greater uncertainty, neglects reflection back to the source antenna due to the presence of a lossy body, and is more time-consuming than dosimetric measurements in homogeneous phantoms. Since such near-field assessments are more conservative, they are rarely conducted in the context of exposure assessments.

In summary, reference levels are easy to assess if the plane-wave or far-field conditions are approximately met (see Section 1.3.2) and the resulting SAR and induced current densities are below the corresponding basic restrictions under all circumstances. The reference limits for occupational/controlled and for the general public/uncontrolled exposure are given in [NCRP \(1986\)](#), [ANSI/IEEE \(1991, 2002b\)](#) and [ICNIRP](#)

([1998](#)). However, sometimes only the incident electric field (E-field) or the E-field-based equivalent power density is also reported for cases in which the above equation is not satisfied and therefore may not well represent true exposure. It should also be noted that the maximum value that is often reported is suitable for reporting compliance with guidelines, but may greatly overestimate typical exposures at that location.

1.4.2 Near-field and dosimetric probes

The first instruments were developed in the early 1970s and they covered the 10 MHz to 10 GHz region of the spectrum. One involved the use of two pairs of thin-film thermo-coupling vacuum-evaporated electrothermic elements that functioned as both antenna and detector ([Aslan, 1970](#)). In another instance, two small diode-loaded dipoles were employed as sensor elements ([Rudge, 1970](#)). In 1975, the first prototype of an isotropic, miniature field probe was introduced ([Bassen et al., 1975](#)). Fibre-optic field probes were proposed as early as the 1970s ([Bassen et al., 1977](#)). Comprehensive overviews of field probes have been published ([Bassen & Smith, 1983](#); [Poković, 1999](#)).

(a) Broadband E-field probes

Diode-based field probes are most commonly used for dosimetric assessments. These instruments consist of field sensors, a detector, transmission lines and readout electronics (Fig. 1.14). The probe is constituted of three mutually orthogonal diode-loaded dipoles with an isotropic receiving pattern. Different orthogonal sensor configurations are available.

An RF detector Schottky-type diode is placed at the centre of the dipole sensor. If the detector diode operates in the square-root law region, the detected voltage is proportional to the RF power. The data-acquisition electronics are connected to the detector diodes by high-resistance transmission lines to minimize incident-field perturbation

Fig. 1.14 Simplified schematic of a broadband-field probe

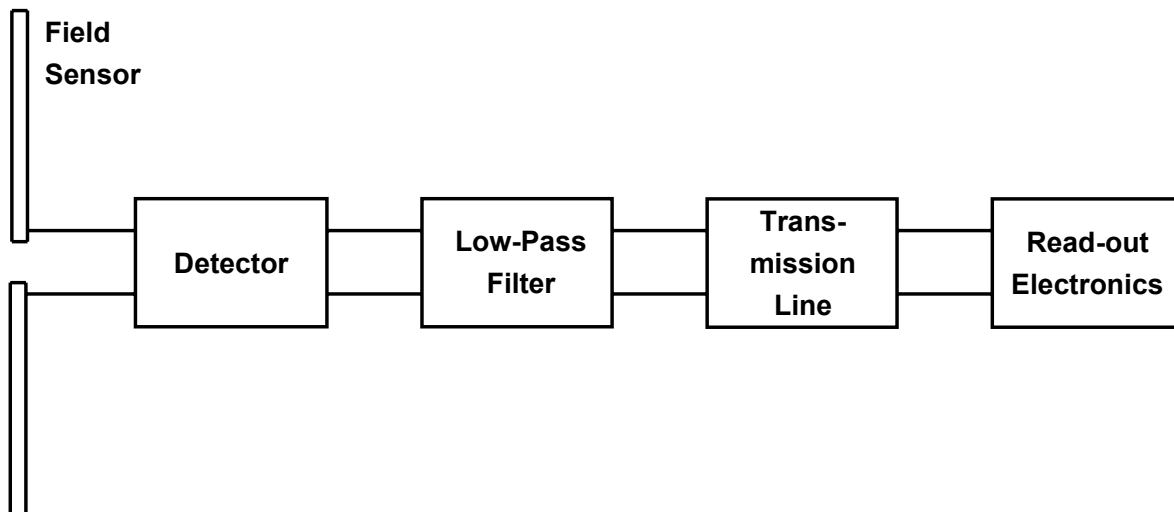

Republished with permission of Taylor and Francis Group LLC Books, from [Kühn & Kuster \(2007\)](#); permission conveyed through Copyright Clearance Center, Inc.

and spurious pick-up effects. A detailed investigation of transmissionline design can be found in [Smith \(1981\)](#).

Magnetic-field (H-field) probes are also available; the basic theory on which such probes are designed can be found in [Whiteside & King \(1964\)](#). H-field probes and E-field probes have similar features except that H-field probes employ a small loop element instead of a dipole sensor. Loop-based sensors present the disadvantage of a strong frequency dependence and induction of currents by both H- and E-fields. Different methods for flattening the frequency response of loop probes have been suggested ([Kanda, 1993](#); [Poković, 1999](#)). Lossy covers have been proposed to further suppress the E-field sensitivity of the loop ([Poković, 1999](#)).

A general problem of diode-based probes is their inherent nonlinearity over their dynamic range. Methods to overcome these limitations are presented in [Kühn et al. \(2007b\)](#).

Unlike diode-based sensors, thermocouple probes are true square-law detectors. Such sensors are particularly useful in free-space field surveys ([Narda STS, 2005](#)). These sensors are, however,

impractical for dosimetric and near-field measurements because of their size, generally lower sensitivity and dynamic range.

Thermistors are also small true square-law detectors. They can have a higher resolution than thermocouples, but need more frequent calibration.

The performance of these probes depends strongly on the following parameters:

- Frequency, modulation, and field strength;
- Polarization, direction of propagation, and field gradients;
- Material boundaries near the probe sensors;
- Sources of interference (noise, static and low-frequency fields, vibration, temperature, etc.).

The influence of these parameters must be characterized by individual calibration under well-defined conditions for each probe. A detailed summary of different calibration methods for field probes and a characterization of the most crucial parameters contributing to the measurement of uncertainty are given in [Poković \(1999\)](#). The influence of these parameters must

be included in the resulting uncertainty assessment, since the conditions of actual use of the probes may differ considerably from the conditions under which they are calibrated.

Modern free-space and dosimetric field probes operate in the frequency band from 10 MHz up to 6 GHz. They have an isotropy error smaller than ± 0.5 dB and sensitivities in the range 5–10 $\mu\text{W/g}$. These probes have very small sensor tips (2.5 mm) to allow high spatial resolution and measurements very close to material boundaries. A probe with reduced size (tip diameter, 1.0 mm) has been described for accurate dosimetric measurements at frequencies exceeding 10 GHz ([Poković et al., 2000a](#)). Probes for determining both the electrical- and magnetic-field pseudo-vector information are presented in [Poković et al. \(2000b\)](#).

(b) *Electro-optical sensors*

Modern, electro-optical sensors allow the measurement of the full RF-frequency domain and phase as well as intermediate-frequency time-domain signal information while maintaining a superior electrical isolation through the use of optical fibres for signal transmission.

In general, two sensor concepts are used today: (1) passive optical sensors ([Togo et al., 2007](#)); and (2) active optical sensors [Kramer et al. \(2006\)](#). Modern passive electro-optical sensors typically modulate the information on laser light passing through electro-optically active crystals embedded in a fibre-optic system. Common crystal materials include cadmium telluride (CdTe) and lithium niobate (LiNbO_3), which change their refractive indices depending on the E-field applied across the crystal, or cadmium manganese telluride (CdMnTe), which is sensitive to the magnetic fields applied across the crystal ([Poković, 1999](#)). The sensitivities of modern active optical sensors can be as low as 100 $\mu\text{V/m}$ per Hz^2 , or greater than 0.3 V/m when measuring a signal of width of 5 MHz ([Kramer et al., 2006](#)).

1.4.3 *Measurement antennae*

Different types of broadband-matched antennae are usually applied for the frequency-selective exposure assessment of incident fields. These broadband antennae are matched to 50 ohm to be compatible with standard RF receivers. They have applications in far-field measurement of radiation, e.g. from cellular base stations and broadcast services.

Common broadband RF-measurement antennae such as horn or log-periodic antennae have a certain directivity. This reduces the applicability of these antennae for complex propagation scenarios, particularly at locations where the incident field is not dominated by a direct line-of-sight propagation path, but by multipath propagation ([Kühn, 2009](#)).

Tuned dipole antennae have an isotropic pattern (no directivity) in azimuth, but lack broadband characteristics.

Conical dipole antennae have an isotropic pattern in azimuth and generally good broadband characteristics ([Seibersdorf Research, 2011](#)), which substantially reduces the number of measurements needed.

1.4.4 *Temperature instrumentation*

(a) *Temperature probes*

Local SAR values can also be assessed by temperature measurements (see Section 1.3); however, thermal-diffusion effects must be practically absent. This is only possible if the system is in thermal equilibrium at the beginning of the exposure, or if heat-diffusion processes are known for the assessment period. Heat losses due to radiation and convection during the measurement interval must be negligible, or known and corrected for. If these heat-diffusion processes are unknown, the response time of the thermal measurement equipment must be sufficiently short to avoid underestimation of the exposure ([Schuderer et al., 2004a](#)).

Two types of temperature probes exist: thermistor-based and those based on optical effects. The requirements for temperature probes for SAR assessments are:

- Small size: the probe must be small to resolve high temperature gradients, without disturbing the temperature distribution or the RF field;
- Non-conductive materials: only electrically non-conductive materials prevent heating of the probe by induced currents because they are transparent to EMFs;
- Low noise level: small differences in temperature must be detected accurately, especially for dynamic temperature measurements, e.g. of SAR, and thus the noise level should be much less than 10 mK;
- Short response time: this is essential for SAR measurements as the temperature rise (dT/dt) is proportional to the SAR only in the absence of heat diffusion. A probe suitable for SAR measurements must have reaction times much faster than 100 ms ([Schuderer et al., 2004a](#)).

A novel design for temperature probes for dosimetric assessments, introduced by [Schuderer et al. \(2004a\)](#), provides a spatial resolution of 0.02 mm^2 , a noise level of the temperature of 4 mK, and a sensitivity of 0.5 mK/s with a response time of $< 14 \text{ ms}$.

Temperature probes based on thermo-optical effects are applied in high-voltage transformers, industrial microwave ovens and in treatment for hyperthermia. One exploited effect is the decay rate of a phosphorescent layer at the tip of a fibre-optic cable ([Wickersheim & Sun, 1987](#)). These commercially available probes have a noise level of 0.1 K, with reaction times of 250 ms. Another optical effect is the interferometric property of a cavity filled with materials that have highly temperature-dependent refractive indices. These probes reach sensitivities of 2–3 mK/s ([Burkhardt et al., 1996](#)).

(b) Infrared photography

The measurement of temperature by black-body-equivalent radiation (infrared photography) is an alternative to invasive measurements using temperature probes. The resolution of infrared thermographs can be very high and the sensitivity of affordable infrared detection systems has improved substantially over the past 30 years. This was also one of the first methods used to measure SAR ([Guy, 1971](#)), as the surface radiation can be recorded quickly with infrared cameras without perturbing the incident field. Infrared cameras were used to measure the temperature increase on a human head exposed to GSM mobile phones ([Taurisano & Vander Vorst, 2000](#)). The technique has several disadvantages:

- Limited sensitivity compared with temperature or dosimetric probes;
- Can be used only for measurements of surface temperature;
- The thermal radiation characteristics of the materials must be determined accurately;
- The background radiation must be homogeneous;
- Evaporation and convection can cause substantial errors and must be controlled;
- Different viewing angles of the camera can yield different results, since surfaces are not isotropic infrared radiators.

(c) Microcapsulated thermo-chromic liquid crystals

A novel idea to assess three-dimensional temperature distributions optically and in quasi real-time was proposed by [Baba et al. \(2005\)](#). Microcapsulated thermochromic liquid crystals (MTLC) were suspended uniformly in a gel with the dielectric properties of human muscle tissue. The temperature of the gel is determined by measuring the light scattered from a laser beam

that scans through the liquid. The technique has limited dynamic range and sensitivity.

(d) *Calorimeters*

Calorimetry encompasses methods for measuring heat produced by biological, chemical or physical endothermic or exothermic processes. Calorimetric methods are suitable for determining average *wbSAR*, but they cannot provide information about *SAR* distribution.

Calorimetry can be subdivided into two types:

- Direct calorimetry: the heat is measured directly by use of calorimeters;
- Indirect calorimetry: the quantity of heat is determined by measuring the amount of oxygen consumption and relating it to the oxaloric equivalent of the reaction.

Basically, calorimetric dosimetry analyses the heating and cooling processes of a sample exposed to RF radiation. Typical direct calorimeters used in microwave dosimetry are the Dewar flask and the twin-well calorimeter ([Gajsek et al., 2003](#)).

1.4.5 *Measuring SAR and the near field*

Dosimetric evaluation inside test phantoms such as SAM requires the measurement of *SAR* at several hundreds of points distributed over a complex three-dimensional phantom. The process is divided into: (1) searching for the location of the maximum absorption on a two-dimensional grid; and (2) determining the *psSAR* value on a fine three-dimensional grid. These points must be determined with high accuracy, especially at high frequencies, to achieve low measurement uncertainty despite high attenuation and large variations in spatial-field intensity. Automated systems for dosimetric assessment have been developed to perform these compliance tests. A typical system for dosimetric assessment is a computer-controlled six-axis robotic positioner. It is used to move the dosimetric E-field probe

within a scanning grid, which can be adaptive, e.g. it follows the surface that is being detected during the scanning job and positions the probe axis orthogonal to that surface. The measurement results, i.e. field and *SAR* distributions, as well as 1 g and 10 g spatial average peak *SAR*, are automatically evaluated and visualized. The expanded standard uncertainty ($k = 2$) is less than 20%. It should be noted that this approach provides reliable conservative estimates of the maximum peak spatial *SAR* that might occur in the user population, but offers little information about the exposure of specific tissues or individual exposure ([Kühn, 2009](#)).

In summary, compliance evaluation of body-mounted transceivers provides reliable conservative estimates of maximum *psSAR*-1 g and *psSAR*-10 g anywhere in the body, but these estimates are generally poorly correlated with the maximum exposure of specific tissues (e.g. brain tissue) or typical exposure levels during daily usage of the device (system- and network-dependent). In other words, the information has only limited value for epidemiological studies.

1.4.6 *Incident-field measurements in the far field*

Evaluation of the exposure in the far field of a transmitter is usually conducted for fixed installations such as radio and television broadcast antennae, radar sites, or cellular base stations. Exposure assessments are carried out in areas that are generally accessible or for which access is restricted to qualified working personnel only. Compliance is tested with respect to the reference levels by assuming free-space field impedance for the RF energy, i.e. by E-field evaluation. Only one measurement point is required under real far-field conditions. However, actual environments usually involve nearby reflectors and scatterers, i.e. a scanning procedure is required to find the maximum incident fields ([Kühn, 2009](#)).

Since the transmitters under evaluation do not always operate at maximum power – the transmitted power of base stations being dependent on traffic intensity – broadband instantaneous measurements are often insufficient to determine the highest level of exposure. In such cases, information on the maximum exposure with respect to the measured values must be available and soundly applied to establish exposure in the worst-case scenario. [Table 1.12](#) lists the parameters necessary for extrapolation of exposure in the worst case and to reduce the uncertainty of the actual measurement campaign. It is easier to determine the measurement methods when additional parameters are known. General sources of error are:

- Field perturbation by measurement personnel, e.g. scattering and absorption of EMFs due to the body of the measurement engineer;
- Application of an inappropriate measurement antenna, e.g. disregard for antenna directivity and polarization;
- Application of ineffectively decoupled cables, acting as secondary antennae;
- Application of incorrect measurement settings of the RF receiver for the type of signal to be measured;
- Incorrect selection of the measurement location, e.g. measurement points that are not appropriate for yielding the maximum EMF exposure or measurement points close to bodies that influence the calibration of the measurement antennae ([Kühn, 2009](#)).

Different methods for assessing EMF exposure in the far field have been proposed. One approach is the antenna-sweeping method. This method requires the engineer to slowly move the measurement antenna with varying polarizations and directions through the volume of interest ([Sektion NIS, 2002](#)). Another method is based on the examination of several well defined points in the area of interest. In this case, the antenna is

mounted on a tripod and the different directions and polarizations are examined at the considered points ([ANFR, 2004](#)). The first method is conservative, but sensitive to the position of the operator with respect to the antenna. With the second method, measurements can be performed with the engineer located further away, but the number of measurements in the volume is small. A combination of both methods is presented by [Coray et al. \(2002\)](#), who suggest that the region is first scanned for the field maximum in the area of interest and that an isotropic and frequency-selective measurement is then performed at the location of the maximum.

Often, far-field techniques are employed in the near field of transmitters, e.g. on transmitter towers. Some standards allow a spatial averaging of E-field evaluations ([ANSI/IEEE, 1991](#)), the rationale of which is based on the wbSAR limit. However, this constitutes a relaxation of the safety criteria as it does not consider H-field coupling as the dominant mechanism in the near field nor the limits of psSAR. On the basis of current knowledge, such relaxations do not exclude the possibility of exceeding the basic restrictions or underestimating the local exposure ([Kühn, 2009](#)).

The advantages and limitations of different measurement equipment for assessing the exposure of unknown transmitters are discussed below.

1.4.7 Broadband measurements

Broadband-measurement probes are single-axis or three-axis sensors (dipole or loop) constructed in a similar way to the near-field sensors. No information on the spectral characteristics of the field is provided by these probes. Therefore, if a broadband meter is used for compliance testing, the measured field value must be no higher than the lowest permissible limit defined for the frequency range of the meter. Broadband survey meters are also

Table 1.12 Important parameters of radiofrequency transmitter sites assessed in the far field

Site parameter	Explanation
Location	The location of the transmitter with respect to the measurement point
Line of sight/nonline of sight	Determines if a prevalent propagation path may be expected
Type of site	Single or multiple antenna site
Antenna directivity	Antenna beam characteristics
Antenna radiation direction	The direction of maximum radiation
Antenna power at measurement	The antenna input power at the time the measurement takes place
Maximum antenna input power	Maximum permissible antenna input power
Frequency	Frequencies at which the site transmits
Communication system	Communication system that is used, i.e. which signal modulation characteristics are to be expected
Other sources of radiation	The field at the measurement points when the assessed transmitter is switched off

Adapted from [Kühn \(2009\)](#)

relatively inexpensive and easy to use, and are thus often used for field-survey measurements ([Kühn, 2009](#)).

Fig. 1.15 displays the components of typical broadband field-survey meters. Fig 1.16 shows the frequency response of two broadband probes.

Some broadband probes are designed to match the frequency dependence of the human exposure limits. In all cases, it is advised that the out-of-band response of these instruments is carefully characterized to avoid spurious readings. If a specific transmitter is the dominant source, compliance testing is substantially simplified ([CENELEC, 2005](#)).

The main sources of uncertainty regarding broadband survey meters are: calibration, linearity, frequency response, isotropy, time-domain response, and temperature response; so the accuracy of broadband evaluations is significantly limited, but generally conservative ([Kühn, 2009](#)).

(a) Frequency-selective measurements

Frequency-selective measurement techniques can overcome the difficulties of the unknown spectrum of the field. However, the execution of the measurement is more complicated and requires specialized engineers.

Measurements in the frequency domain are performed with an antenna connected to a spectrum analyser.

Most spectrum analysers provide video filters for additional smoothing of the spectral signal. Optimal parameter settings for the analyser for GSM and UMTS based on a simulation approach have been presented ([Olivier & Martens, 2005, 2006](#)). The application of spectrum analysers is a complex topic. Procedures dealing with frequency-selective measurements should always describe the parameter settings of the spectrum analyser to produce correct, reproducible and comparable results. Nevertheless, the engineer should test the actual applicability of these settings for the particular measurement equipment ([Kühn, 2009](#)).

The main sources of uncertainty regarding frequency-selective measurements are:

- Calibration of the spectrum analyser, cable, and measurement antenna;
- Linearity of the spectrum analyser, cable, and measurement antenna;
- Frequency response of the spectrum analyser, cable, and measurement antenna;
- Demodulation method of the spectrum analyser (detector type);

Fig. 1.15 Schematic of the most common broadband radiofrequency field-survey meters

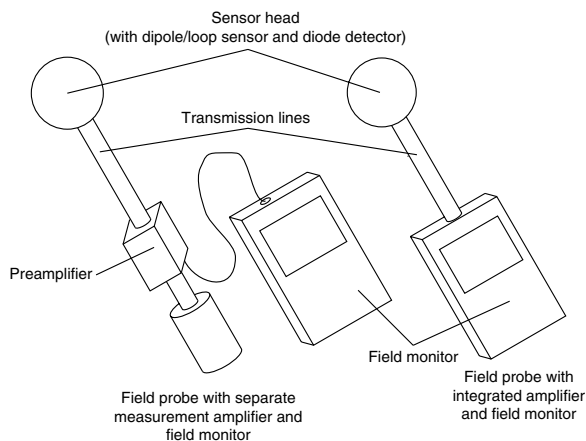

Republished with permission of Taylor and Francis Group LLC Books, from [Kühn & Kuster \(2007\)](#); permission conveyed through Copyright Clearance Center, Inc.

- Temperature response of the spectrum analyser, cable, and measurement antenna; and
- Mismatch between measurement equipment.

Although frequency-selective measurement methods overcome most of the problems affecting use of broadband-survey meters, they are not always sufficient to correctly evaluate exposure from different transmitters operating at the same frequency. In this case, measurement receivers should be applied ([Kühn, 2009](#)), as presented below.

(b) Code-selective measurements

Code-selective measurements are specifically necessary when the exposure from a transmitter involves code-division multiple access (CDMA), e.g. when a Universal Mobile Telecommunications System (UMTS) is to be assessed. All UMTS base stations usually transmit in the same frequency band. With a frequency-selective receiver, it is not possible to discriminate between exposures from different base stations, because a single frequency band is used and the channels are multiplexed in the code domain. Code-selective

receivers decode the signal received from a base station, i.e. the receiver is able to discriminate between the received field strength from its base station and other noise-like sources. The receiver measures only the field received from its transmitting base station if the particular descrambling code is used for decoding. Basically, the same sources of uncertainty must be considered for code- and frequency-selective measurements. In general, if measurement receivers are applied, the overestimation of the measured field values is expected to be smaller than for frequency-selective and broadband measurements ([Kühn, 2009](#)).

1.4.8 Calibration

Measurement with known uncertainty can only be performed if the measurement equipment is appropriately calibrated. In general, calibration of the measurement equipment is demanding (sensitivity as a function of frequency and modulation, linearity for different modulations, deviation from isotropy, etc.). High-quality calibration documentation is essential to determine the accuracy of the measurements or their uncertainty, respectively.

1.4.9 Uncertainty assessment

Exposure assessments are prone to many uncertainties that must be carefully determined. This is the most difficult aspect of any measurement protocol, because it usually covers many more parameters than only the uncertainties associated with the measurement equipment. For example, in the case of demonstration of compliance with respect to basic restrictions, it includes estimation of the coverage factor for the exposed populations. In the case of uniform incident field, it is necessary to determine the uncertainty of the field measured during the period of measurement with respect to the maximum exposure at this site. In case of non-uniform fields, it needs to

Fig. 1.16 Frequency response of two broadband radiofrequency field-survey meters

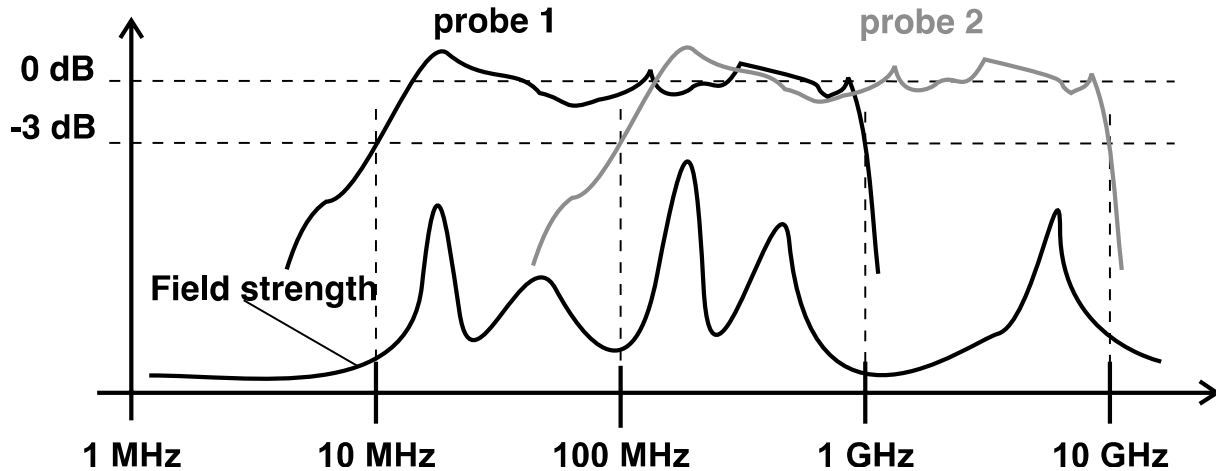

The fields in the frequency ranges are summed. If the outputs from probes 1 and 2 are added, then the fields in the overlapping frequency range are counted twice. The field values measured with probe 1 must comply with the lowest limit in the frequency band 10 MHz to 1 GHz, while the readout of probe 2 must comply with the lowest limit between 100 MHz and 10 GHz. The overlapping frequency range is surveyed twice if the exposure values are superimposed to cover the entire frequency range. Republished with permission of Taylor and Francis Group LLC Books, from [Kühn & Kuster \(2007\)](#); permission conveyed through Copyright Clearance Center, Inc.

be demonstrated that the ratio of measured fields to reference levels is conservative with respect to the induced fields.

[The Working Group noted that it should be good measurement practice for the results of any measurement campaign to be presented only when accompanied by an extensive uncertainty assessment.]

1.4.10 Specific measurement problems

(a) Demonstration of compliance with dosimetric safety limits

The objective of compliance demonstration is to determine the exposure conservatively for the range of intended usage of the device or equipment with respect to the entire user group. In general, there is a strong dependence on position, distance, anatomy and posture. This dependence can only be determined by numerical simulations. Given an acceptable uncertainty, several hundred permutations of the most important parameters must be performed. In other words, the parameter space is large and the assessment

must be done with sufficient care and followed by an extensive discussion on the parameters investigated and the resulting uncertainties.

(b) Assessing personal exposure

In its most recent update of *Research Agenda for Radiofrequency Fields*, the World Health Organization (WHO) has recommended improvement of exposure assessment in epidemiological studies as a high-priority research need: “Quantify personal exposures from a range of radiofrequency sources and identify the determinants of exposure in the general population” ([WHO, 2010a](#)).

Associated problems with personal exposure assessment are:

- Compliance tests versus real-life exposure;
- Assessment of incident versus induced fields;
- Appropriate dosimetric quantities;
- Combination of exposure from multiple sources operating at different distances and frequencies;

- Strong temporal, geographical and usage dependence of the exposure, especially in relation to the exposure period relevant to the epidemiological data;
- Technology dependence of exposure and rapid technological changes; and
- Selection and, even more importantly, exclusion of potential exposure proxies.

As mentioned before, the worst-case levels of exposure determined during compliance testing of, e.g. mobile phones or base stations are in many cases not representative of actual real-life and everyday exposure. The protocols for compliance testing are generally optimized to provide a conservative estimate of maximum exposure. However, exposure assessment in epidemiological research aims at categorizing actual personal exposure. Results from compliance testing can, however, be useful to validate propagation models ([Bürge et al., 2008](#)), or to compare potential proxies that can be independently assessed, such as those based on mobile-phone design ([Kühn, 2009](#)).

Assessment and dosimetry of EMF exposure in epidemiological and human studies have been and often still are performed in terms of quantities that are only representative for demonstration of compliance with safety guidelines, e.g. incident-field quantification, or induced wbSAR and psSAR. The dosimetric meaning of the aforementioned quantities is questionable for current studies, which all aim at detecting potential effects for exposures well below established safety levels. In addition, the end-points investigated are typically effects on specific tissues, organs or functional regions of the brain and the quantification of the classical dose evaluations often does not allow a clear distinction between body regions or an accumulation of the dose from various sources. Quantification of exposure in terms of incident fields is especially problematic, since incident fields are often not directly related to induced fields. A common mistake is to combine exposure in terms of incident fields at different

frequencies by applying the root-sum-square (see Glossary) over the individual frequency contributions. Currently, novel dosimetric models are being developed to relate incident to induced EMF ([Djafarzadeh et al., 2009](#)) or to relate SAR-compliance test data measured in homogeneous media to SAR in specific anatomical regions of the human brain ([Gosselin et al., 2011](#)). By expressing exposure directly in terms of induced EMF or SAR in specific regions, the combination of multiple sources also becomes straightforward. Also, it allows a direct assessment of different source contributions according to geographical location or usage.

Variations due to geographical location in the far-field of transmitters should only be addressed with validated propagation models (e.g. [Andersen et al., 2007](#); [Frei et al., 2009a](#)), and not with, e.g. simplistic distance metrics. For near-field exposure, e.g. from mobile phones, the orientation of the source with respect to the body is relatively well defined; however, due to the output power control of modern mobile devices, there can be large variation in exposure depending on geographical location (more than twofold) and, even more importantly, the communication system (a factor of 100 or more). The assessment of these variations is typically addressed in terms of measurements in situ ([Wiaart et al., 2000](#); [Kühn, 2009](#); [Kelsh et al., 2010](#)).

(c) *Measurement of the very close near field below 10 MHz*

The assessment of human exposure at frequencies between 30 MHz and 6 GHz is well established. International standards and national guidelines provide detailed assessment methods that are well specified with relatively low uncertainty. The measurement of incident fields at frequencies below 10 MHz is also well established. However, there is comparatively little research on the measurement of induced fields at frequencies below 10 MHz. The problems

associated with induced-field measurement at frequencies below 10 MHz include:

- Strong spatial non-uniformity of the fields, requiring high resolution of measurements;
- Strong temporal variation in the fields, especially from signals with transients, requiring equipment to have a large operating bandwidth;
- Field values measured very close to the source greatly overestimate the induced values, i.e. compliance often needs to be demonstrated by assessment of the induced fields;
- High variation in the permittivity and conductivity of tissues, making human modelling (e.g. development of phantoms) difficult;
- Practical limitations in the use of time-domain numerical electromagnetic solvers at low frequencies, resulting in slow convergence; and
- Limitations in the applicability of certain frequency-domain numerical electromagnetic solvers (e.g. electro-quasistatic solvers) due to assumptions and approximations.

(d) Measurement of signals with complex modulations

Today, most broadband field probes, as well as personal exposure meters, are calibrated with narrow-band (single-frequency) continuous wave signals. However, the measured signals differ greatly from continuous wave signals in terms of variation in time-domain amplitude and signal bandwidth. Variation in the time-domain amplitude of modern communication signals (peak-to-average power ratio [PAPR] of up to 14) places great demands on the linearity of the detectors in broadband probes and exposure meters, and in spectrum analysers. These requirements are often not fulfilled for the detectors and filters in traditional field probes

and exposure meters, such that these respond differently when comparing continuous wave and waveforms applying modern modulation schemes. For compliance testing, field probes can be calibrated with the actual test signals. For measurements in situ, e.g. with exposure meters, such a calibration is not straightforward since the real-life communication-signal characteristics might not always remain constant during measurement. Care should be taken also when using narrow-band receivers, i.e. spectrum analysers, when measuring complex-modulation waveforms. Also, these receivers require modulation-specific measurement settings, e.g. filter, detector, resolution bandwidth, sweep time etc. to perform field measurements with reasonably small uncertainties ([Joseph et al., 2002, 2008](#); [Olivier & Martens, 2005, 2006](#)).

1.5 Interaction of RF-EMF with biological systems

Although numerous experimental studies have been published on the non-thermal biological effects of RF-EMF, multiple computational analyses based on biophysical and thermodynamic considerations have concluded that it is theoretically implausible for physiological effects (except for reactions mediated by free radical pairs) to be induced at exposure intensities that do not cause an increase in tissue temperature ([Foster, 2000](#); [Adair, 2002, 2003](#); [Sheppard et al., 2008](#)).

RF electromagnetic radiation is classed as non-ionizing radiation as it comprises photons that do not have sufficient energy to break chemical bonds or ionize biological molecules ([Stuchly, 1979](#)). The energy of a photon of an electromagnetic wave is given by $E = hf$, where h is Planck's constant (6.626×10^{-34} J•s or 4.136×10^{-15} eV•s) and f is frequency, thus the energy of a photon in the RF spectrum varies from approximately 4.1×10^{-6} eV (6.6×10^{-25} J) at 1 GHz to 1.2×10^{-3} eV

(2.0×10^{-22} J) at 300 GHz. This is thus far less than the minimum amount of energy needed to ionize organic materials or metals, which is approximately 5–10 eV.

When a biological body (animal or human) or tissue is exposed to an RF-EMF, the RF energy is scattered and attenuated as it penetrates body tissues. Energy absorption is largely a function of the radiation frequency and the composition of the exposed tissue. Because of the high dielectric constant of water, the water content of the tissue determines to a large extent the penetration of a frequency-specified electromagnetic wave. The rate of energy absorbed by or deposited per unit mass per unit time is the specific absorption rate (SAR); this value is proportional to the root-mean-square (rms) of the induced electrical field strength $[E]^2$ and to the electrical conductivity (σ) of the tissue per tissue density (ρ):

$$\text{SAR} = [E]^2 \cdot \sigma / \rho$$

The SAR expressed in units of watts per kilogram (or mW/g) can also be estimated from measurements of the rise in temperature caused by RF-energy absorption in tissue:

$$\text{SAR} = C_p \cdot \delta T / \delta t$$

where C_p is the specific heat of the tissue or medium, $\delta T / \delta t$ is the initial rise in temperature over time. Values for the dielectric constant and conductivity vary substantially over the RF range (30 MHz to 300 GHz).

To cause a biological response, the EMF must penetrate the exposed biological system and induce internal EMFs. RF-energy absorption depends on incident field parameters (frequency, intensity, polarization), zone of exposure (near field or far field), characteristics of the exposed object (size, geometry, dielectric permittivity and electric conductivity), and absorption or scattering effects of objects near the exposed body ([Stuchly, 1979](#)).

Based on the relationship between wavelength (λ) and frequency

$$c = f \cdot \lambda$$

where c is the speed of light (3×10^8 m/s), it is obvious that the wavelength of RF radiation varies substantially between 30 kHz (10 km) and 300 GHz (0.1 cm). At the frequencies used for mobile phones (approximately 1–2 GHz), the corresponding wavelengths are 30 and 15 cm. Considering that near-field exposures occur at distances from a radiating antenna within approximately one wavelength of the radiated EMF and that far-field exposures occur at distances that exceed one wavelength of the radiated EMF, it is clear that reactive near-field and far-field exposures may occur, depending on the frequency of the incident field and the distance of the exposed person from the radiating antenna. Both near-field and far-field exposures can occur with the use of wireless telecommunication devices. In the near-field region, the electric and magnetic fields are decoupled and not uniform, wave impedance varies from point to point, power is transferred back and forth between the antenna and the surrounding object, and the energy distribution is a function of both the incident angle and distance from the antenna ([Lin, 2007](#)). Because the electric and magnetic fields are decoupled in the near field, the induced field can be obtained by combining the independent strengths of the electric and magnetic fields, i.e. the electric and the magnetically induced electric fields inside the body ([Lin, 2007](#)).

1.5.1 Thermal effects

The most recognized effect of RF radiation in biological systems is tissue heating. The absorption of RF-EMF energy by biological systems generates an oscillating current that is transferred into molecular motion of charged particles and water molecules, which are strongly dipolar and

are the major component of biological tissues. Polar molecules move to align themselves with the EMF to minimize the potential energy of the dipoles. Absorption and resonant oscillations in polar subgroups of macromolecules (e.g. proteins, DNA) are largely damped by collisions with surrounding water molecules. Damping or friction slows the motion of the oscillator. These collisions disperse the energy of the RF signal into random molecular motion. Tissue heating occurs because the rotational motion of molecular dipoles is hindered by the viscosity of water and interactions with other molecules, i.e. the rotational energy is transferred to the surrounding aqueous environment as heat. The magnitude of motion that results from the interaction of polar substances with electric fields is dependent on the strength and frequency of the field. In addition, the actual increase in temperature is dependent on the ability of the organism to thermoregulate. At high frequencies where the orientation of dipoles cannot keep up with the oscillations of the field, the system behaves like a non-polar substance (Stuchly, 1979).

As electrical fields penetrate complex biological tissues, the electric field is reduced as a result of dielectric constituents becoming polarized in response to the field. Standards for RF exposure of workers and the general population are based on protection against adverse effects that might occur due to increases in tissue or body temperature of 1 °C (wbSAR, ~4 W/kg) or less (after applying safety factors). Because RF-energy penetration and induced effects are dependent on the frequency of incident-field parameters and the composition of exposed tissues, quantifying SARs in small averaging regions is more relevant for evaluations of human health effects. Estimates of SARs in the head of individuals exposed to RF radiation during use of mobile phones that operate at a power output of 0.25 W indicate that the emitted energy would cause a rise in brain temperature of approximately 0.1 °C (Van Leeuwen *et al.*, 1999; Wainwright, 2000);

therefore, it has been suggested it is unlikely that effects in the brain would be caused by increases in temperature (Repacholi, 2001). However, it is possible that temperature-sensitive molecular and physiological effects occur already with an increase of the temperature of ≤ 0.1 °C, while temperature changes approaching 1 °C are likely to affect several biological processes (Foster & Glaser, 2007).

Rates of temperature increase may be important in affecting a physiological change. Indeed, microwave-induced heating has been attributed to a rapid rate of heating 1–10 °C/s, which leads to acoustic waves due to expansion of tissue water. This auditory effect associated with brief pulses (1–10 μ s) at frequencies of 1–10 GHz and peak power-densities of $\sim 10^4$ W/m² (10³ mW/cm²) occurs with only small increases in temperature in the head (Foster & Glaser, 2007). Low levels of exposure to RF radiation may result in small temperature changes that cause conformational changes in temperature-sensitive proteins and induce the expression of heat-shock proteins; studies on the effects of low intensity RF-EMF exposures on temperature changes and expression of heat-shock proteins are described in Section 4 of this *Monograph*.

1.5.2 Physiological effects

Non-thermal effects (or effects associated with a negligible increase in temperature) are defined as biological changes that occur with body temperature changes that are < 1 °C, below measurable heating, or in the range of thermal noise. Several arguments have been presented against the plausibility of a non-thermal mechanism by which RF radiation could affect physiological changes; these include: (a) damping effects of the water surrounding biological structures are too strong to allow resonances to exist at radiofrequencies (Adair, 2002); (b) the relaxation time – the time for a molecule to return from an excited state to equilibrium – for excitations produced

by RF fields (e.g. vibrations in molecules), is similar to the relaxation time for thermal noise, and shorter than the lifetime of the absorption and transfer of energy into resonant modes of oscillating elements in biological systems ([Adair, 2003](#)); and (c) the perturbation of the biological structure induced by the applied field must be greater than the effects of random thermal motion and the effects of other dissipative forces, such as viscous damping by the surrounding medium ([Foster, 2000](#)). Random thermal motion of charged components in biological systems (i.e. thermal noise) creates random fluctuating EMFs. [Adair \(2003\)](#) has concluded that it is unlikely that RF radiation with a power density of less than 10 mW/cm^2 (100 W/m^2) could have a significant effect on biological processes by non-thermal mechanisms.

[Sheppard et al. \(2008\)](#) have evaluated several potential mechanisms of interaction of RF radiation with biological systems and concluded that, other than heating and possible effects on reactions mediated by free radical pairs, RF field strengths in excess of system noise (collisions among various molecular oscillators generated largely by thermal agitation) could not alter physiological activities without also causing detectable tissue heating. Some mechanistic considerations addressed by these authors include:

- *Endogenous electric fields* involved in physiological processes (e.g. embryonic development, wound healing, and neuronal activity) have strengths in the range 1–200 V/m. While neuronal circuit oscillations were affected *in vitro* by extremely low-frequency electric fields, no mechanisms for inducing changes in cell-membrane potential at frequencies above ~10 MHz have been demonstrated. Furthermore, the net field effect on such a biological system would be the sum of the endogenous and applied fields. Thus, to alter a biological response such as ion

transport through a membrane channel, the amplitude of the external signal would need to be of the same order of magnitude as the endogenous field ([Adair, 2003](#); [Sheppard et al., 2008](#)).

- *Specialized sensory systems* may be capable of detecting weak EMFs by integrating signals from numerous sensors over space and time. While specific sensory systems have been shown to exist for low-frequency, infrared and visible radiation, there is no evidence for the existence of RF-sensitive receptors in biological systems ([Sheppard et al., 2008](#)). However, some sensory systems may respond to very small increases in temperature ($< 0.1 \text{ }^\circ\text{C}$).
- *Effects of weak RF fields that do not cause heating* would be likely to require frequency-dependent resonant absorption or multiple-photon absorption to induce an amplified signal strong enough to overcome intrinsic molecular noise ([Sheppard et al., 2008](#)). This is because the photon energy of RF radiation is much smaller than thermal energy at body temperature ($k \cdot T$, where k is the Boltzmann constant, $1.38 \times 10^{-23} \text{ J/K}$ ($8.62 \times 10^{-5} \text{ eV/K}$), and T is the absolute temperature), i.e. $27 \times 10^{-3} \text{ eV}$ per oscillating mode at body temperature. However, biological systems appear to absorb RF signals like a broadband receiver rather than eliciting line spectra characteristic of resonant vibrational motion ([Prohofsky, 2004](#); [Sheppard et al., 2008](#)). In addition, RF electric field strengths of up to 200 V/m cannot transfer sufficient energy to organelles or biological molecules to alter biological activities or affect thermal noise (kT) fluctuations, such as the opening of voltage-gated ion channels, spatial arrangements of membrane-associated ions, collision rates of charged ligands with proteins, or enzyme reaction kinetics ([Adair, 2002, 2003](#);

[Sheppard et al., 2008](#)). [Adair \(2002\)](#) suggested that, while coupling of RF-EMF to biological systems may exhibit resonance behaviour, damping of the vibrational motion by interactions with the aqueous environment prevents the absorption of sufficient energy to induce a biological effect. To significantly affect a biological system, the response from the RF signal must be comparable to the effect of thermal noise ([Adair, 2003](#)).

- *RF-EMF may be directed to specific sites* of a biological structure, leading to local areas of enhanced field strength. However, the smallest focal spot of concentrated energy would have a radius of the order of a wavelength, which is much larger than most cells (e.g. at 300 GHz, $\lambda = 1000 \mu\text{m}$). Thus, on a cellular basis, RF-energy absorption is very small. [Fröhlich \(1968\)](#) has suggested that incident RF energy may be captured by a large group of oscillating dipoles and integrated into a single mode of coherent vibrational energy. For this to occur and produce a coherent response, [Sheppard et al. \(2008\)](#) suggested that the energy stored in the coupled oscillators would need to be comparable to thermal energy and protected from damping by water or other molecules. In addition, energy and thermal diffusion prevent the formation of significant temperature differences at the cellular and subcellular levels.
- *In order for RF electric fields to induce small changes in protein structure* that would affect binding of substrates or ligands to enzymes or receptor proteins, extremely high field strengths would be required ($\sim 10^9 \text{ V/m}$) ([Sheppard et al., 2008](#)).

Since living systems are not in thermal equilibrium, mechanistic theories on interactions between RF-EMF and biological tissues must consider the non-equilibrium and nonlinearity

of these systems. [Binhi & Rubin \(2007\)](#) suggest that biochemical effects may be induced by weak EMFs in targeted systems that are in non-equilibrium states in which the time to transition from an intermediate metastable state to a final active or inactive state may be less than the thermalization time of the induced field.

[Prohofsky \(2004\)](#) has suggested that protein conformation might be affected by RF radiation if amplitudes of specific vibrational modes were altered. However, only intermolecular vibrational modes of proteins and the surrounding tissue are possible at RF frequencies, because high-frequency intramolecular resonant vibrational modes exist above several hundred GHz. Further, this author concluded that the biological effects of RF radiation in macromolecules (proteins and DNA) can only be due to temperature changes, because the absorbed energy associated with intermolecular vibrations is rapidly thermalized; the relaxation time for coupling RF waves to surrounding water (i.e. damping) is faster than the speed with which it can be transferred to intramolecular resonant modes. A non-thermal effect might exist if there were a very strong energy coupling between the intermolecular and intramolecular modes. Exceptions to the above-mentioned considerations are proteins such as myoglobin or haemoglobin, in which the haem group can oscillate in the protein pocket at lower frequencies (184 GHz is the lowest mode in myoglobin) ([Prohofsky, 2004](#)).

Any theories on the potential effects on biological systems of RF energy at low field strengths must account for the facts that biological systems do not exist at equilibrium, that the dynamic nature of these systems is controlled by enzyme-mediated reactions, and that primary effects may be amplified by nonlinear biological processes ([Georgiou, 2010](#)). The reproducibility of reported effects may be influenced by exposure characteristics (including SAR or power density, duration of exposure, carrier frequency, type of modulation, polarization, continuous versus

intermittent exposures, pulsed-field variables, and background electromagnetic environment), biological parameters (including cell type, growth phase, cell density, sex, and age) and environmental conditions (including culture medium, aeration, and antioxidant levels) ([Belyaev, 2010](#)).

A biophysical theory on how low-intensity RF-EMF exposures might affect physiological functions involves the alteration of ligand binding to hydrophobic sites in receptor proteins ([Chiabrera et al., 2000](#)). Collisions of the ligand ion in the hydrophobic region of the receptor protein result in loss of its vibrational energy. In order for RF exposures to affect the binding probability of an ion ligand with a membrane protein receptor, basal metabolic energy would have to amplify the effect of the RF field by maintaining the cell in thermodynamic non-equilibrium. Otherwise, the low-intensity exposure would be negligible compared with thermal noise. Other elements of this model that were used to evaluate the effects of low-intensity RF exposures on ligand binding are the extremely fast (“instantaneous”) rearrangement of atoms in the hydrophobic core of protein by the ligand ion, the fact that the endogenous field at the protein boundaries is large enough to exclude water molecules from the hydrophobic core, and that the ion-collision frequency near the hydrophobic binding site is much less than it is in water. The authors of this study noted that thermal noise must be taken into account when evaluating potential biological effects of RF exposures ([Chiabrera et al., 2000](#)).

Demodulation of pulsed RF signals (e.g. GSM pulsed at 217 Hz) might produce low-frequency electric fields ([Challis, 2005](#)). To confirm a biological effect from a low-frequency, amplitude-modulated RF signal, a nonlinear response in the biological sample would be expected ([Balzano & Sheppard, 2003](#)). Except for the case of an incident flux of RF energy at extremely high field-strength pulses that causes mechanical vibrations, most oscillators in a biological system respond linearly to the incident low-energy

photons in the RF spectrum; the dispersion of RF energy into random molecular motion energy occurs without generating harmonics of the incident signal in the energy spectrum of re-radiated photons by the exposed material. However, the authors of this study considered the possibility that demodulation of high-frequency incident RF signals might produce nonlinear interactions with biochemically induced transient oscillators in living tissues (e.g. uncoupled electrons of free radicals) by extracting low-energy signals. If this occurred, then the spectrum of RF-emission energy emitted from the exposed tissue would be altered, producing a second harmonic that would show up as a spectral line at twice the frequency of the incident signal ([Balzano & Sheppard, 2003](#)). Sensitive, frequency-selective instruments are available to detect the presence of frequency-doubling signals produced by nonlinear interactions between amplitude-modulated RF signals and molecular oscillators vibrating in unison in living cells ([Balzano, 2003](#)). Exposure of several different types of cell and tissue to continuous wave fields (input powers of 0.1 or 1 mW) in a double-resonant cavity at the resonant frequency of the loaded cavity for each sample (~880–890 MHz) did not emit second harmonic signals at twice the frequency of the incident signal ([Kowalczyk et al., 2010](#)). SAR values were approximately 11 mW/g for cells and 2.5 mW/g for tissues exposed to 1 mW RF fields. Although these results were inconsistent with the hypothesis that living cells can act as effective radio receivers and demodulate RF energy, a second harmonic response may be elicited by much more intense continuous waves (which would be likely to cause rapid heating) or very short-pulsed RF signals ([Kowalczyk et al., 2010](#)). [Sheppard et al. \(2008\)](#) concluded that it is unlikely that modulated RF fields significantly affect physiological activities of membranes, because non-thermal stimulation of cell membranes has not been observed above approximately 10 MHz and the voltage across a cell membrane from an

amplitude-modulated RF electric field of 100 V/m is much lower than the low-frequency voltage noise associated with membrane voltage fluctuations. Much higher incident field strengths, at levels that would cause significant tissue heating, would be needed to create electric fields comparable with endogenous fields.

Lipid-protein complexes appear to be more sensitive to perturbations from RF radiation at membrane phase-transition temperatures ([Liburdy & Penn, 1984](#); [Allis & Sinha-Robinson, 1987](#)). [Blackman et al. \(1989\)](#) suggested that the chick brain surface is also poised at a phase transition at physiological temperatures, and the long-range order that occurs in such a state would minimize the thermal noise limitations calculated for single-phase systems on signal detection of weak RF radiation. Consistent with this hypothesis, [Blackman et al. \(1991\)](#) observed that RF radiation-induced calcium-ion efflux-changes occurred only within the narrow temperature range of 36–37 °C.

The aggregation of dielectric objects by attractive forces between them is referred to as the pearl-chain effect ([Challis, 2005](#)). RF fields of about 125 V/m and at frequencies of up to about 100 MHz can produce oscillating fields in cells that enhance their attraction. At higher frequencies the induced dipoles might not have sufficient time to reverse direction and, therefore, stronger fields would be needed to produce the same attractive energy.

Electroporation is a process by which short pulses (~100 μs) of strong electric fields (e.g. 10–100 kV/m) are applied to cell membranes to induce transient pores that allow uptake of drugs, DNA, or other membrane-impermeable substances ([Foster, 2000](#); [Sheppard et al., 2008](#)). These changes occur without causing significant tissue heating or thermal damage.

1.5.3 Magnetic-field effects

Low-frequency magnetic fields might produce biological effects if they induce ferromagnetic resonance in tissues that contain high concentrations of iron particles (magnetite) ([Challis, 2005](#)).

Free radicals, which are highly reactive molecules or ions with unpaired electrons, are formed when radical pairs dissociate. By altering the recombination of short-lived radical pairs with antiparallel spins, low-intensity magnetic fields may increase the concentration of free radicals ([Challis, 2005](#); [Georgiou, 2010](#)). The expected increase in radical concentration is 30% or less ([Timmel et al., 1998](#)). The extent to which this increase can produce oxidative stress-induced tissue damage (e.g. membrane-lipid peroxidation or DNA damage) is not known. Furthermore, radicals are also a part of normal cellular physiology, being involved in intracellular signal transduction ([Finkel, 2003](#)). Therefore, even small effects on radical concentration could potentially affect multiple biological functions. By prolonging the lifetime of free radicals, RF fields can increase the probability of free-radical-induced biological damage. To affect DNA recombination and thus the repair of damage caused by radicals, external magnetic fields must act over the times that the radical pairs dissociate ($> 10^{-9}$ s); hence, [Adair \(2003\)](#) concludes that the effect of RF fields on free-radical concentrations would likely be limited to about 10 MHz or less. Resonance phenomena occur below 10 MHz, and may result in biological effects from low-level RF fields at about 1 MHz ([Henbest et al., 2004](#); [Ritz et al., 2009](#)).

[Georgiou \(2010\)](#) cited several studies that provide evidence for the induction of oxidative stress via the free-radical pair mechanism in biological systems exposed to RF radiation; some of the reported effects include increased production of reactive oxygen species, enhancement of oxidative stress-related metabolic processes, an increase in DNA single-strand breaks, increased

lipid peroxidation, and alterations in the activities of enzymes associated with antioxidative defence. Furthermore, many of the changes observed in RF-exposed cells were prevented by (pre)treatment with antioxidants.

1.5.4 Conclusion

In conclusion, tissue heating is the best-established mechanism for RF radiation-induced effects in biological systems. However, there are also numerous reports of specific biological effects from modulated RF-EMF, particularly low-frequency modulated fields (see Section 4). Mechanistic studies will be needed to determine how effects that are reproducible might be occurring, e.g. via the induction of reactive oxygen species, induction of ferromagnetic resonance, demodulation of pulsed RF signals, or alteration of ligand binding to hydrophobic sites in receptor proteins. Although it has been argued that RF radiation cannot induce physiological effects at exposure intensities that do not cause an increase in tissue temperature, it is likely that not all mechanisms of interaction between weak RF-EMF (with the various signal modulations used in wireless communications) and biological structures have been discovered or fully characterized. Biological systems are complex and factors such as metabolic activity, growth phase, cell density, and antioxidant level might alter the potential effects of RF radiation. Alternative mechanisms will need to be considered and explored to explain consistently observed RF-dependent changes in controlled studies of biological exposure (see Section 4 for examples of reported biological effects). While the debate continues on whether or not non-thermal biological effects occur as a result of exposures to low-intensity RF radiation, it may be difficult to specify observed effects as non-thermal because of the high sensitivities of certain physiological responses to small increases in temperature.

1.6 Exposure to RF radiation

Exposure of workers and the general community to RF radiation can occur from many different sources and in a wide variety of circumstances. These exposures can be grouped into three major categories: personal, occupational and environmental.

1.6.1 Personal exposure

The general community can come into contact with several potentially important sources of RF radiation as part of their personal life, involving some degree of choice, including use of a mobile phone, other communication technologies, or household devices (see Section 1.2).

(a) Mobile phones

(i) Increase in mobile-phone subscriptions

Analogue mobile phones were first introduced around 1980 and GSM phones in the mid-1990s. Over the past two decades, the number of people owning a mobile phone has increased rapidly around the world. For example, the number of mobile-phone subscribers in the USA has risen from 0.34 million in 1985 to 109 million in 2000, and 263 million in 2008 ([InfoPlease, 2011](#)). WHO has estimated that at the end of 2009 there were 4.6 billion mobile-phone subscriptions globally ([WHO, 2010b](#)). Fig 1.17 illustrates the rapid rise in mobile-phone subscriptions compared with other types of phone and Internet usage over the past decade, although it should be noted that the number of subscriptions does not equate to number of users, as some people have more than one subscription and a single subscription can be used by more than one person.

This rapid increase in mobile-phone use is not just restricted to the industrialized countries. Fig 1.17 shows the increase in mobile-phone subscriptions from 2000 to 2007 in high-, middle- and low-income countries ([World Bank, 2009](#)). While industrialized countries continue to

Fig. 1.17 Mobile-phone subscriptions per 100 people in high-, middle-, and low-income countries, 2000 and 2007

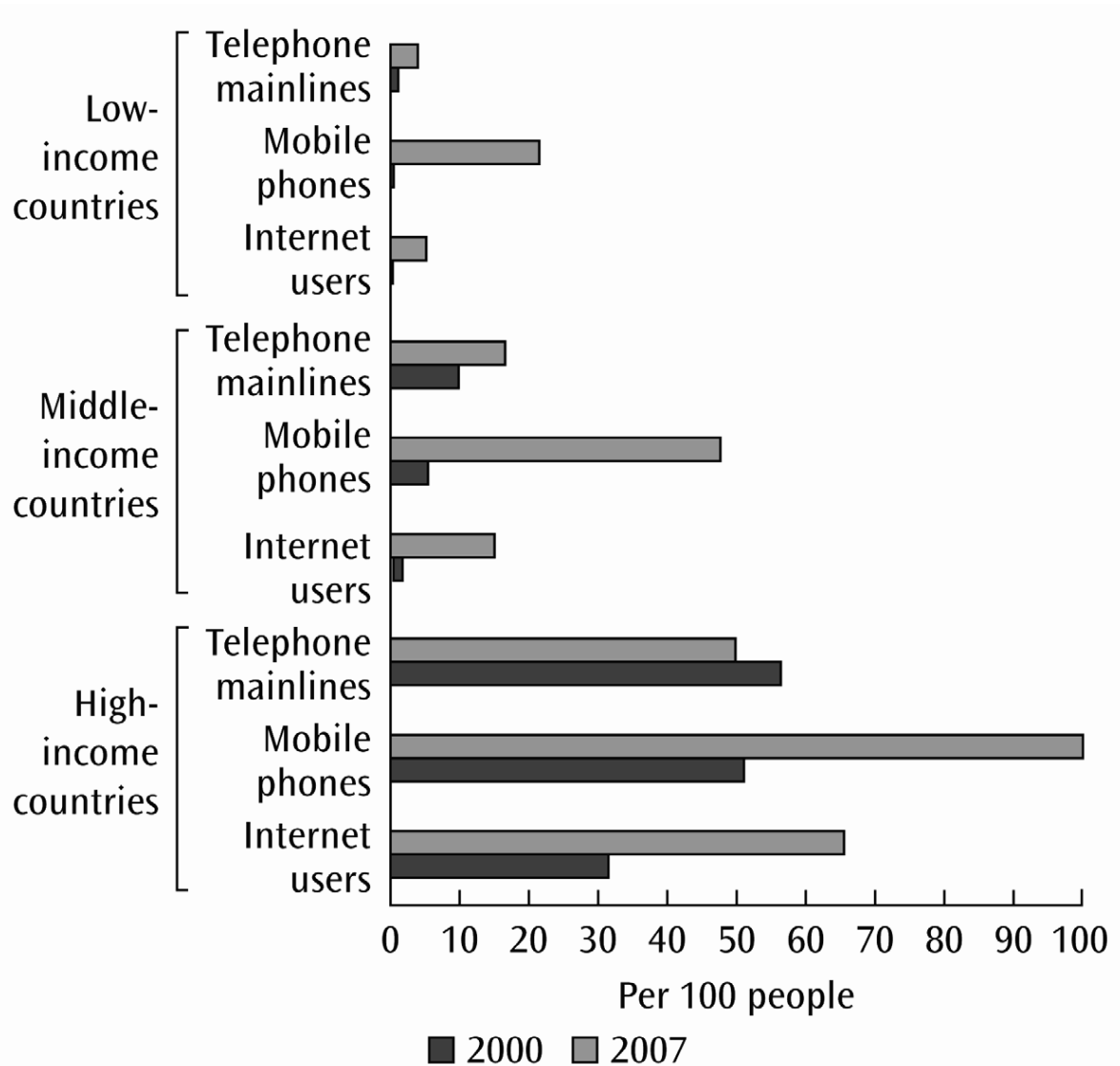

© World Bank
From [World Bank; International Monetary Fund \(2009\)](#)

have the highest number of subscriptions per 100 people, the percentage increase over this time has been much greater in low- and middle-income countries. In low-income countries, subscription rates in 2000 were negligible, but in 2007 they were 25% of the rate in high-income countries, while in middle-income countries the rise was from about 10 to 50 subscriptions per 100 people, to reach about 50% of the rate in high-income countries in 2007.

There have also been considerable changes in the types of mobile phone used over the past 10 years, which has important implications for RF exposure of the user (see Section 1.2). Earlier mobile phones used analogue technology, which emitted waves of 450–900 MHz. Digital phones, with RF frequencies of up to 2200 MHz, were introduced in the mid-1990s and by the year 2000 had almost completely replaced analogue phones. The largest growth in recent years has been for smartphones, which allow the user access to a wide range of non-voice data applications (taking photographs, Internet access, playing games, music, and recording videos). In the USA, 18% of phones in 2010 were smartphones, up from 13% in 2008 ([Nielsen, 2010](#)).

(ii) Mobile-phone use among children

Within the increasing subscription figures, there have been questions raised about increasing use of mobile phones by children. As was seen in Section 1.3, published dosimetry studies using phantom heads have found that RF absorption can be higher in children than in adults, due to anatomical and physiological differences. A recent study used a modified version of the Interphone questionnaire in 317 children in secondary school (median age, 13 years) in one state of Australia, and found that 80% used a mobile phone ([Redmayne et al., 2010](#)). Data on national use of mobile phones in 2009, collected by the Australian Bureau of Statistics (ABS), has shown that 31% of Australian children had a mobile phone, with the highest ownership being

in the age group 12–14 years (76%) ([ABS, 2009](#)). Similar rates of mobile-phone use by children were found in three major cities in Hungary in 2005, where 76% of children in secondary school owned a mobile phone, 24% used a mobile phone daily to make calls, and an additional 33% used mobile phones to make calls at least several times per week ([Mezei et al., 2007](#)).

While the increase in mobile-phone subscriptions over the past 15 years is well documented, less is known about changes in call frequency and duration over that time. One study in Finland found that the median duration of calls per month was 186 minutes in 2007, increasing to 221 minutes in 2009, while the average monthly number of calls increased slightly from 52 to 57 calls ([Heinävaara et al., 2011](#)). The daily local RF exposure of the general public has increased by several orders of magnitude with the introduction and proliferation of mobile handsets. This has triggered concern among health agencies and the public, since the tissue with the highest exposure is the brain. Figs 1.18 and 1.19 display the frequency of worst-case SAR from mobile phones, measured according to [IEEE \(2003\)](#) and [CENELEC \(2001\)](#) guidelines.

Fig. 1.18 represents the typical SAR values for Europe (mean psSAR-10 g, 0.74) and Fig. 1.19 for North America (mean psSAR-1 g, 0.96). The different averaging masses are due to different legal regulations in Europe and the USA. These values are a considerable percentage of the limit values (see Section 1.7). A recent statistical analysis of the SAR database of the Federal Communications Commission (FCC) found that the SAR values of newer phones are typically lower than those of older phones, despite the greatly reduced size (see Section 1.3).

(iii) Exposure metrics for epidemiological studies

To develop suitable exposure metrics for use in epidemiological studies on RF exposure from mobile phones and health effects such as cancer, there is a need to access technical data such as

Fig. 1.18 Statistical distribution of maximum psSAR-10 g measured for 668 mobile phones, according to standard EN50361 ([CENELEC, 2001](#))

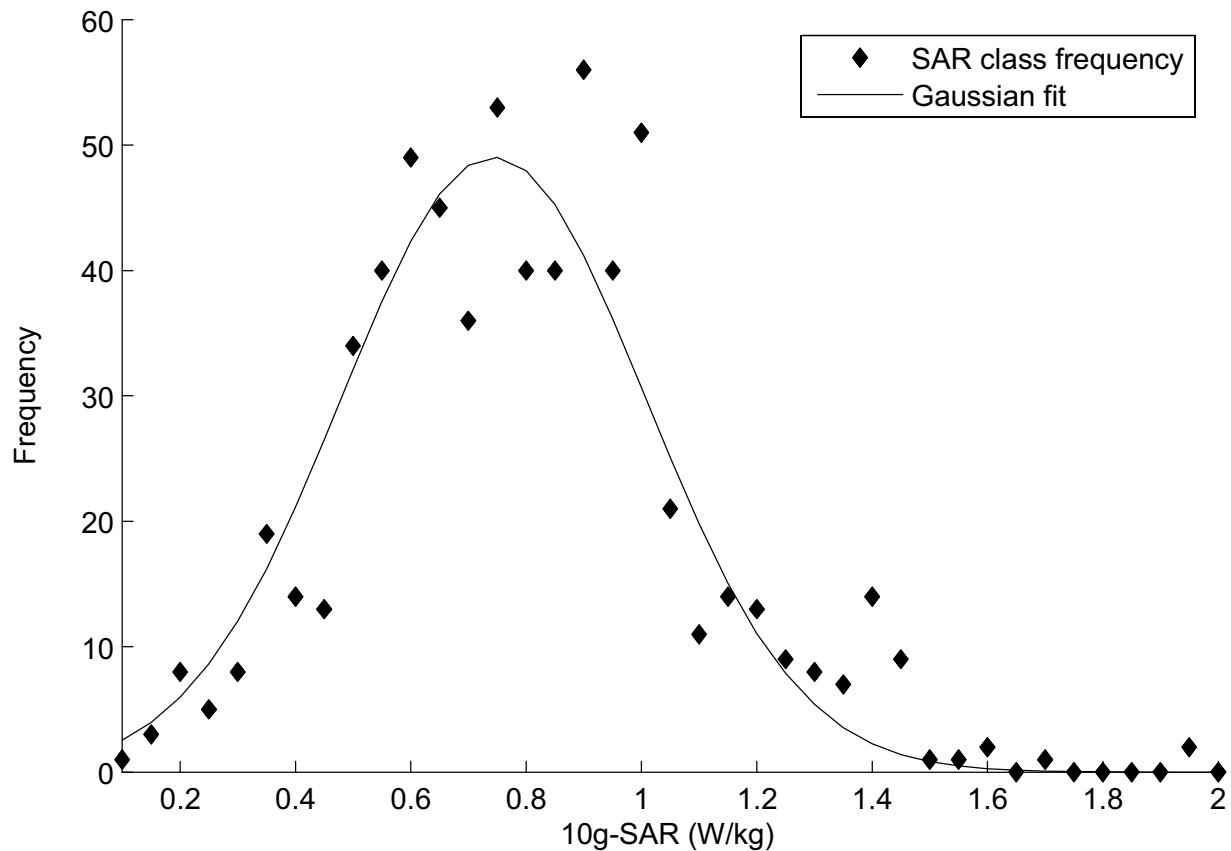

Data from German Federal Office for Radiation Protection, in [Kühn & Kuster \(2007\)](#)

the generation of phone, frequency, modulation and network-related factors that might influence the output power of the phone, as well as reliable information about the pattern of mobile-phone use from each subject. This includes such variables as reported number of calls, duration of calls and laterality, i.e. the side of the head on which the phone is most often placed by the subject when talking on the phone.

As exposure data related to mobile-phone use are usually collected from the subjects themselves, several studies have been conducted to test the validity of this type of self-reported information. Several methods are available to validate self-report, including telephone-company records, software-modified phones

and hardware-modified phones ([Inyang *et al.*, 2008](#)). A study of 59 children in the seventh year of school (age 11–12 years) in Australia used GSM-type software-modified phones to record exposure details (e.g. number and duration of calls) to validate questionnaire data on mobile-phone use. This study found a modest correlation of 0.3 for recall of number of calls, but almost no correlation (0.1) for duration ([Inyang *et al.*, 2009](#)). There was little difference with the main findings for different demographic groups, although for some subgroups, numbers were small. This study was carried out over one week and a possible explanation of the poor correlations is that the change in phone type imposed by the study protocol (from 3G to GSM) may have

Fig. 1.19 Statistical distribution of maximum psSAR-1 g measured for 687 mobile phones, according to standard IEEE-1528 ([CENELEC, 2001](#))

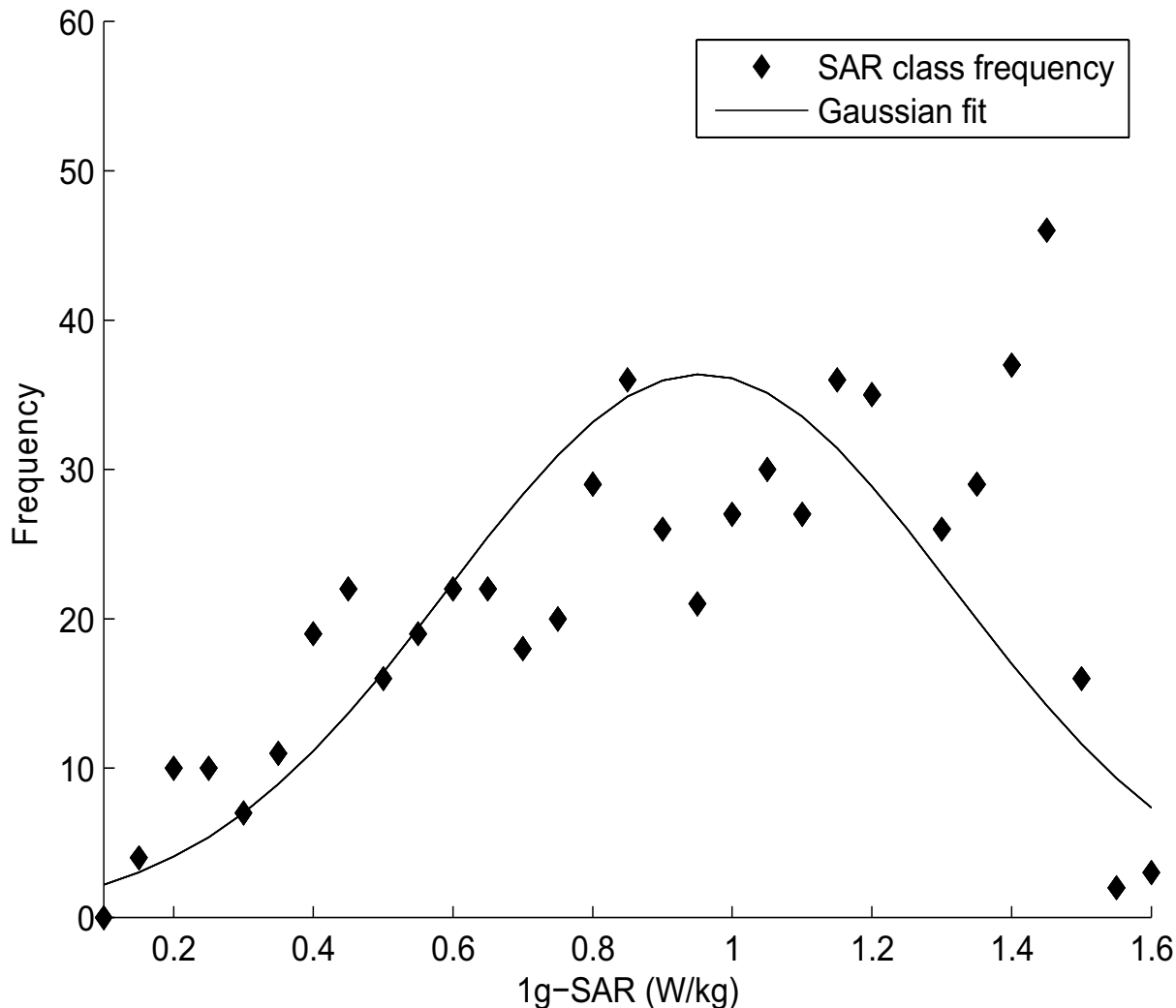

Data from Federal Communications Commission, in [Kühn & Kuster \(2007\)](#)

resulted in a change in phone-use behaviour for many of the children.

Another potential problem is differential recall of mobile-phone use in case-control studies. In the CEFALO case-control study of brain tumours in adolescents, a validation study was undertaken to estimate the effect of both random and systematic errors in 59 cases (26% of all cases who owned a mobile phone) and 91 controls (22% of all controls who owned a mobile phone) for whom phone-use data were available

from the mobile-phone provider ([Aydin *et al.*, 2011](#)). The study found that cases overestimated their number of calls by 9% on average, and controls overestimated by 34% on average. Cases also overestimated the duration of their calls by 52% on average, while controls overestimated by a much greater 163%, suggesting that duration-of-call data from self-reports are less reliable and may be more prone to recall bias than self-reports of number of calls in studies of cancer in children.

Such differential reporting between cases and controls was not such a problem in two validation studies undertaken as part of the Interphone case-control study of brain tumours in adults. A 6-month volunteer study used the Interphone questionnaire and either phone records or software-modified phones in 11 countries and found that, although there was considerable random error, there was fair to moderate agreement for both number and duration of calls, with weighted kappas ranging from 0.20 to 0.60 ([Vrijheid et al., 2006](#)). In addition, there was some systematic error, as heavy users tended to overestimate their use, while lighter users tended to underestimate theirs. There was also some heterogeneity between countries. A subsequent validation study among subjects from five countries in the Interphone study compared reported mobile-phone use against phone records over an average of two years. This substudy found that the extent of underreporting of number of calls (0.8) and of over-reporting of call duration (1.4) was similar in each group. Differential recall was greater with longer periods of recall, although numbers were small for the group with longest recall period ([Vrijheid et al., 2009b](#)). More recently, a pilot study in Finland for the prospective cohort study of mobile-phone users (COSMOS study) validated reported phone use against phone-company records for 418 subjects who had a single operator ([Heinävaara et al., 2011](#)). The authors found that overestimation of reported mobile-phone use was common and there was moderate agreement ($\kappa = 0.60$) for monthly average duration of calls, although there was more overestimation and less agreement as the call duration increased. A further small validation study in 60 engineers and scientists, who are not representative of the wider community, used mobile-phone records to validate self-reporting and found similar agreement; the conclusion was, that reporting monthly use was more reliable than weekly or daily use ([Shum et al., 2011](#)).

Laterality, i.e. against which ear the mobile phone is mainly held during calls, is another important factor that can influence estimations of exposure within the head. Laterality does not always coincide with the subject's dominant hand and may be related to other activities, such as writing. A validation study of self-reported laterality with hardware-modified phones found that agreement between the information from these phones and self-reported laterality was modest, with a kappa of only 0.3 ([Inyang et al., 2010](#)). [Schüz \(2009\)](#) demonstrated that laterality effects are similar across exposure categories and highlighted the problem of possible reporting bias. The Interphone study has addressed this problem in a sensitivity analysis, whereby different allocations of side-of-head were used; this caused only minor reductions in the odds ratios for the highest quintile of exposure, which suggests that the findings are not sensitive to errors in the recall of laterality of phone use ([Cardis et al., 2011a](#)).

Mobile phones are low-powered RF transmitters, operating at frequencies between 450 and 2700 MHz, with peak powers in the range of 0.1 to 2 W, the power being highest during a call. The handset only transmits RF power when it is turned on, but the newer smartphones regularly give short bursts of power to check e-mails and other Internet services. One study has found that mobile-phone output power is usually higher in rural areas where base stations are further apart, whereas the other factors examined in the study (length of call, moving/stationary, indoor/outdoor) were found to be of less importance as predictors of power output from the phone ([Hillert et al., 2006](#)).

Using a mobile phone in areas of good reception (such as in cities where mobile phone-base stations are close together) also decreases exposure as it allows the phone to transmit at reduced power. Conversely, people using a phone in rural areas where mobile-phone reception is poorer may receive higher RF exposure. This was one

factor examined in a study of 512 subjects in 12 countries who were asked to use GSM software-modified phones; the study, monitored date, time and duration of each call, frequency band and power output for a month ([Vrijheid et al., 2009a](#)). The main predictors of power output were the study location, the network, and the duration of the call, with shorter calls being associated with higher power output. The measured power levels in GSM networks were substantially higher than the average levels theoretically achievable, which has important implications for estimating exposure in epidemiological studies. Rural location was only a major factor in Sweden, where subjects were living in very sparsely populated areas; these results are consistent with those of an earlier paper from [Lönn et al. \(2004\)](#) in Sweden, who reported that the highest power level was used about 50% of the time in the rural areas, but only about 25% of the time in urban areas. This highlights the problem of identifying genuinely sparsely populated rural areas where major differences in power output can be found. Another paper from the Interphone study reported an investigation of the effects of parameters that were thought to influence the level of RF SAR in the brain. Total cumulative specific energy was estimated, based on data collected during the Interphone study, to assess the relative importance of the different factors and these results were used to develop an algorithm, which was tested on study subjects in five countries ([Cardis et al., 2011b](#)). This study found that the type of phone with the highest mean total specific cumulative energy (TSCE) was AMPS800 (5165 J/kg), followed by D-AMPS800 (3946 J/kg), GSM800/900 (2452 J/kg), GSM1800 (4675 J/kg), CDMA1900 (1855 J/kg), and CDMA800 (164 J/kg). The main determinants were communication system, frequency band, and number and duration of mobile-phone calls. The study also identified several uncertainties in relation to SAR estimation, including those related to spatial SAR distribution for each phone

class, error in recall of phone use, and laterality and uncertainties about the most biologically relevant dose metric.

A study in the USA examined the impact of phone type and location by use of software-modified phones driven over several pre-determined routes ([Kelsh et al., 2010](#)). This study found that RF levels were highest for the older analogue phones, intermediate for GSM and TDMA phones, and lowest for CDMA phones. The main predictors of RF level were phone technology and, to a lesser extent, degree of urbanization.

Patterns of personal mobile-phone use have been changing as technology has changed and this can have implications for the strength of the RF field experienced by the user. One important development has been the introduction of the short message service (SMS), which was originally designed for GSM to allow sending non-voice text messages ([Herring, 2004](#)). SMS was first introduced in 1993, but use increased rapidly in the mid-2000s. Text messaging using SMS leads to lower RF exposure than voice calls in two ways: the phone is usually held at least 30 cm from the body during the writing and sending of an SMS and the duration of power output is much shorter (about 11 seconds) than the duration of a voice call.

As with SMS, other mobile-phone communication innovations have been developed that result in lower potential for SAR exposure than voice calls. A person using a mobile phone at least 30 cm away from the body, e.g. when accessing the Internet, with a hands-free device for voice calls or “push-to-talk” with the phone held in front of the head, will therefore have a much lower exposure to RF than someone holding the handset against the head during a voice call.

(b) DECT phones

Another important source of personal RF exposure is the home use of DECT phones, which have been replacing traditional handsets in the home. As the DECT base-station is within

the home and at most some tens of metres from the handset, the average power generated by the DECT phone is less than that of a mobile phone, where the base station may be up to some kilometres away. However, the power output of a DECT base station in close proximity to a person may be comparable to that of a 3G phone, so proximity to a DECT phone base-station should be taken into account when estimating RF exposure in epidemiological studies in which sizeable numbers of subjects have used 3G phones. A recent study of Australian schoolchildren found that 87% had a DECT phone at home, and although there was only a weak correlation ($r = 0.38$) between mobile-phone and DECT-phone use, this suggests that DECT-phone use needs to be considered in the assessment of RF exposure ([Redmayne et al., 2010](#)).

(c) *Other communication technologies and domestic sources*

The incident-field exposures from typical devices used in home and office environments have been assessed ([Kühn et al., 2007a](#)). The maximum E-field exposure values for different device categories are summarized in [Table 1.13](#). The incident-field exposure from cellular base stations may be exceeded by the exposure from these devices due to the generally closer distances involved.

Additionally, an incident exposure of 1 V/m translates to a psSAR value in the brain that is approximately 10 000 times lower than the maximum exposure from a handset. Thus, handsets are by far the most dominant source of RF exposure for the general population.

Within homes there are many other potential sources of RF exposure, including baby monitors, microwave ovens, Wi-Fi, Bluetooth, various types of radios and remote-controlled toys. A study of 226 households in lower Austria measured the peak power of emitted bursts of RF exposure from each of these types of devices in bedrooms, where the residents spend the most

Table 1.13 Worst-case E field at distances of 20 cm and 1 m from typical wireless indoor devices

Device class	Frequency range (MHz)	Worst-case E field (V/m)	
		20 cm	1 m
Baby surveillance	40 – 863	8.5	3.2
DECT	1880 – 1900	11.5	2.9
WLAN	2400 – 2484	3.9	1.1
Bluetooth	2402 – 2480	3.1	1.0
PC peripherals	27 – 40	≤ 1.5	≤ 1.5

DECT, digital enhanced cordless telecommunications; PC, personal computer; WLAN, wireless local area network

Adapted from [Kühn et al. \(2007a\)](#)

time in one position. The highest peak RF values were measured for mobile-phone and DECT base stations in the 2400-MHz band ([Tomitsch et al., 2010](#)).

1.6.2 Occupational exposure

There are many occupations involving potential sources of exposure to RF radiation in the workplace, the more important of which involve work with high-frequency dielectric heaters (PVC welding machines) and induction heaters, broadcast sources, high-power pulsed radars, and medical applications including MRI and diathermy.

(a) *High-frequency dielectric heaters and induction heaters*

High-frequency dielectric heaters (PVC welding machines) functioning at 27 MHz have traditionally involved the highest occupational exposures to RF ([Allen, 1999](#)). This is not a large sector of the industrial workforce, although it is estimated that there are about 1000–2000 PVC dielectric welders in Finland, which has a total population of about five million people. The whole-body average SAR for dielectric heater operators has been estimated to vary from 0.12 to

2 W/kg and it is not uncommon for these workers to report heating effects ([Jokela & Puranen, 1999](#)).

(b) *Broadcasting sources*

The rapid increase in mobile-phone use and other communication technologies worldwide has required increasing numbers of workers to undertake monitoring and maintenance. A study of exposure to RF radiation from two medium-sized antenna towers in Finland was conducted to document worker exposure ([Alanko & Hietanen, 2007](#)). These towers contained transmitting antennae of several different types, mobile-phone networks (GSM900 and GSM1800), radio and digital television substations and other radio systems. Although the measured power density was quite variable, the maximum instantaneous power density at this site was 2.3 W/m², which was recorded during maintenance tasks at the tower with the GSM1800 antennae. For the tower with both GSM900 and GSM1800 antennae, the maximum registered instantaneous power density inside the climbing space was 0.4 W/m². [The Working Group agreed with the authors who concluded that exposures will depend on the different types of antennae located on the towers and that it is usually difficult to predict occupational RF exposures.]

The above approach to assess exposure is based on spot measurements and does not give an estimate of cumulative exposure over working time, which is the approach employed with other types of workplace hazards. Attempts have been made to employ this cumulative dose approach for exposure to RF radiation, but as there are usually many different sources of RF radiation present in a workplace, this is not straightforward. For example, such an approach was used to assess total exposure and estimate an annual dose on fast patrol boats in the Norwegian Navy, which carry high-frequency antennae and radar ([Baste et al., 2010](#)). This study found considerable variation in exposure at different points around the boats, the highest exposures and

annual dose being found in the captain's cabin. These estimates were done for three time periods (1950–79, 1980–94 and 1995+), and relied on recall of transmission characteristics over several decades. The estimated annual doses in the most recent period were about one third of those in the earliest period. The estimated annual doses for the period from 1995 and later ranged between 4.3 and 51 kVh/m.

(c) *Other potential sources of radiofrequency radiation in the workplace*

Portable radios, short-wave and surgical diathermy are other potential sources of RF radiation in the workplace, whereas base stations, microwave links and microwave ovens have been considered unlikely to give rise to substantial exposures ([Allen, 1999](#)). For example, a study of exposure to RF radiation in police officers operating speed guns (measurements made at the seated ocular and testicular positions) found that almost all of the 986 measurements made for 54 radar units were below the detection limit, the highest power-density reading being 0.034 mW/cm² ([Fink et al., 1999](#)).

1.6.3 *Environmental exposure*

The most common sources of RF in the general environment are mobile-phone base stations, which tend to be operated at the lowest power possible for reasons of network efficiency (see Section 1.2; [Allen, 1999](#)). The level of RF exposure is usually poorly correlated with proximity to the antenna, although there is considerable variation in output power from site to site (Section 1.2). A study regarding indoor incident-field exposure from cellular base-station sites was conducted by Austrian Research Centers (ARCS) in the city of Salzburg, Austria ([Coray et al., 2002](#)). [Table 1.14](#) shows two cumulative incident-field exposure values (sum of incident-field exposure from multiple transmitters at one site) measured at different distances from several base-station

Table 1.14 Measurement of indoor incident electric-field (E) strength at base stations in Salzburg, Austria^a

Base station	Measurement 1		Measurement 2	
	Distance to base station (m)	Cumulative incident E field (V/m)	Distance to base station (m)	Cumulative incident E field (V/m)
1	196	0.37	347	0.35
2	88	0.51	108	0.89
3	9	0.034	15	0.037
4	16	0.62	8	1.00
5	85	0.94	152	0.75
6	81	1.8	85	1.71
7	4	3.9	25	1.02
8	93	0.19	208	0.19
9	34	0.40	55	0.63
10	39	1.9	76	2.8
11	174	0.59	220	0.45
12	41	0.70	107	0.67
13	2.5	0.25	5.5	0.15

^a For each base station site, two examples of measurements of cumulative incident field exposure (sum of incident field exposure from multiple transmitters at one site) at different distances are shown.

Compiled by the Working Group from BAKOM Report, [Coray et al. \(2002\)](#)

sites. The values are between 0.1 and 1 V/m for distances of up to several hundreds of metres. Values greater than 1 V/m and up to 3.9 V/m were measured for distances of less than 86 m. These data also underline that the distance to the base station site has a poor correlation for the incident exposure. Similar results were reported in a study that also included outdoor measurement points and addressed the time dependence, i.e. traffic dependence of the exposure from cellular base stations. The results showed a substantial time dependence for base stations with multiple traffic channels. In these cases, clearly lower exposure can be expected at night and at weekends ([Bornkessel et al., 2007](#)).

In an attempt to measure typical exposure to RF radiation over a whole week, volunteers in a Swiss study were asked to wear an RF exposimeter and to complete an activity diary ([Frei et al., 2009b](#)). The main contributions to exposure were found to come from mobile-phone base stations (32.0%), mobile-phone handsets (29.1%) and DECT phones (22.7%).

[Breckenkamp et al.](#) undertook a validation study of exposure to RF radiation in 1132 households in Germany located within 500 m of at least one mobile-phone base station (average number of base stations, 3.4; average number of antennae, 17) ([Breckenkamp et al., 2008](#)). An exposure model was developed, based on 15 parameters related to the base station and the antennae, from the database of the federal network agency and information about the home from the residents and interviewer. Dosimetric measurements were undertaken in the bedroom of the home in 2006. There was considerable variability across cities (range of kappa values, 0.04–0.49), with higher kappa related to low-density housing with buildings comprising more than three floors. There was greater agreement for households located less than 300 m from the base stations and the authors concluded that the model was only useful where high-precision input data were available.

Little is known about geographical variation in exposures in different settings in the general community, but published data related

to exposures within different forms of transport, homes, offices and outdoors in five European countries were reviewed in a recent study ([Joseph et al., 2010](#)). Power density (mW/m^2) was measured in each microenvironment and highest exposures were measured in transportation, followed by outdoor environments, offices and homes. In the Netherlands, the highest exposures were measured in the office environment. In all studies, the lowest exposures were in the home, with exposures of about $0.1 \text{ mW}/\text{m}^2$ recorded in all countries. In transport vehicles, virtually of the exposure was from mobile phones, whereas in offices and homes, the sources were quite variable between countries. [The Working Group suggested that these conclusions should be treated with some caution, as it was not clear how representative the measured microenvironments were.]

In a feasibility study in Germany, the aim of which was to develop reliable exposure metrics for studies of health effects of exposure to RF radiation from mobile-phone base stations, data were collected on distance to base station and spot measurements at the homes of nine controls taking part in a case-control study of cancer. Distance from base station was a poor proxy for the total power density within the home due to the directional characteristics of the base-station beam, scattering, shielding and reflection of the radiated fields and the contribution to power density from other sources ([Schüz & Mann, 2000](#)). [The Working Group noted that use of this metric would be likely to result in considerable exposure misclassification.]

A further study of a random sample of 200 subjects in France used a personal exposure meter to estimate the doses, time patterns and frequencies of RF exposures with measurements of electric-field strength in 12 different bands at regular intervals over 24 hours ([Viel et al., 2009](#)). This allowed differentiation of different sources of RF radiation, including mobile-phone base stations. For each of GSM, DCS and UMTS, more

than 96% of the measurements were below the detection limit and the median of the maximum levels for all three systems ranged between 0.05 and $0.07 \text{ V}/\text{m}$. In addition, exposures were found to vary greatly at similar distances from GSM and DCS base stations, although two peaks were observed (at 280 m mainly in urban areas, and 1000 m mainly in periurban areas), although most distances exceeded the 300 m within which the exposure model developed by [Breckenkamp et al. \(2008\)](#) was found to have the highest agreement with measured levels.

In another study by [Frei et al. \(2009a\)](#), the aim was to develop a model to predict personal exposure to RF radiation. One hundred and sixty-six subjects carried a personal dosimeter for one week and completed a diary. Important predictors of exposure were housing characteristics, ownership of communication devices, time spent in public transport, and other behavioural aspects, with about half of the variance being explained by these factors.

A range of personal exposure meters is now available. These are more robust for the purposes of exposure assessment in epidemiological studies, and a considerable step forward compared with the traditional spot-measurement approach, which is usually chosen for compliance purposes and does not result in a representative estimate of personal exposure ([Mann, 2010](#)). [The Working Group noted that care needs to be taken in interpreting the results of personal exposure measurements, because of the low sensitivity and the failure to account for the fact that they respond to TDMA signals, which may lead to an overemphasis of DECT, Wi-Fi and GSM phone signals in average exposure. Because burst powers may have been measured for these signals, rather than average powers, any exposure proportions attributed to source categories in these studies should be treated with caution when assessing exposure for epidemiological studies.]

1.7 Exposure guidelines and standards

Guidelines and standards for limiting human exposure to RF fields have been developed by several organizations, the most prominent being those of the International Commission on Non-Ionizing Radiation (ICNIRP) and the Institute of Electrical and Electronic Engineers (IEEE). ICNIRP published its present RF guidelines in 1998 ([ICNIRP, 1998](#)) and restated them in 2009 ([ICNIRP, 2009a](#)). IEEE published its present guidelines in 2005 ([IEEE, 2005](#)), but its 1999 guidelines are still used in some countries ([IEEE, 1999](#)).

These guidelines contain restrictions on exposure that are intended to assist those with responsibility for the safety of the general public and workers. The guidelines provide clearly defined exposure levels below which the established acute health effects of exposure are avoided. Exposures can be measured or calculated and compared with these values. If exposures are found to be above the guideline values, measures are put in place to reduce exposure. The guidelines apply to all human exposures to EMFs, irrespective of how such exposures arise, and they do not make specific mention of sources.

The guidelines are not mandatory by themselves, but have been adopted by regulatory authorities and governments in many countries/regions of the world in a variety of different ways. Some regulatory regimes focus on limiting exposures of the public and/or workers, while others focus on limiting product emissions (to control exposures) as part of the certification process before placing products on the market. For example, harmonized technical standards have been implemented in Europe that provide a basis for assessing exposures from equipment such as mobile phones and ensuring that exposures are below values taken from the ICNIRP guidelines. The values in the 1999 IEEE guidelines are used

in a similar way in countries such as the USA and Canada.

1.7.1 Scientific basis

Both ICNIRP and IEEE have reviewed the broad base of the scientific evidence in developing their guidelines and arrived at similar conclusions regarding the evidence for health effects. This consensus is well expressed in the following excerpt taken from the ICNIRP 2009 restatement of its guidelines ([ICNIRP, 2009b](#)):

It is the opinion of ICNIRP that the scientific literature published since the 1998 guidelines has provided no evidence of any adverse effects below the basic restrictions and does not necessitate an immediate revision of its guidance on limiting exposure to high frequency EMFs. The biological basis of such guidance remains the avoidance of adverse effects such as ‘work stoppage’ caused by mild whole body heat stress and/or tissue damage caused by excessive localized heating.

Absorption of RF fields in the body tissues leads to the deposition of energy in these tissues and this energy adds to that produced by metabolism. This energy imposes an additional thermoregulatory burden on the organism and the temperature can increase if the energy absorption rises above a certain level (see Section 1.3). Localized temperature increase can occur in response to localized absorption of energy and the core body temperature can go up in response to generalized absorption of energy throughout the body tissues. The ICNIRP guidelines ([ICNIRP, 1998](#)) conclude from the literature that:

Established biological and health effects in the frequency range from 10 MHz to a few GHz are consistent with responses to a body temperature rise of more than 1 °C. This level of temperature increase results from exposure of individuals under moderate environmental conditions to a wbSAR of approximately 4 W/kg for about 30 minutes.

Table 1.15 Basic restrictions on SAR (W/kg), as taken from the ICNIRP and IEEE exposure guidelines

Body region	Workers/controlled			General public/uncontrolled		
	ICNIRP (1998)	IEEE (1999)	IEEE (2005)^d	ICNIRP (1998)	IEEE (1999)	IEEE (2005)
Whole body ^a	0.4 (6)	0.4 (6)	0.4	0.08 (6)	0.08 (30)	0.08
Head and trunk ^{a,b}	10 (6) [10]	8 (6) [1]	10 (6) [10]	2 (6) [10]	1.6 (30) [1]	2 (30) [10]
Extremities ^{a,b,c}	20 (6) [10]	20 (6) [10]	20 (6) [10]	4 (6) [10]	4 (30) [10]	4 (30) [10]

^a In round brackets after the SAR value is the averaging time in minutes. The averaging times vary with frequency in the IEEE guidelines and the values given are for the 400 MHz to 2 GHz range typically used for mobile communication.

^b In square brackets (where relevant) is the averaging mass in grams: the averaging mass is specified as a contiguous tissue volume by ICNIRP and as in the shape of a cube by IEEE.

^c Extremities are taken as the hands, wrists, feet and ankles in the context of the [IEEE \(1999\)](#) guidelines, distal from the knees and elbows in the [IEEE \(2005\)](#) guidelines, and as the entire limbs in the context of the ICNIRP guidelines.

^d The restrictions apply over the frequency range 100 kHz to 6 GHz in the case of [IEEE \(1999\)](#).

ICNIRP, International Commission on Non-Ionizing Radiation Protection; IEEE, Institute of Electrical and Electronics Engineers; SAR, specific absorption rate.

Compiled by the Working Group

Effects due to whole-body heating are also considered for frequencies below 10 MHz and down to 100 kHz; however, wavelength becomes progressively larger in relation to the body dimensions as frequency decreases to below 10 MHz and coupling to the fields becomes progressively weaker, with the result that less energy is absorbed. Above 10 GHz, absorption of RF fields by the body tissues becomes so strong that the RF fields are considered to be absorbed within a few millimetres of the body surface; hence the guidelines are designed to restrict surface heating.

A further class of thermal effect can be elicited with pulse-modulated RF waveforms, including certain radar signals. This effect is known as the microwave auditory effect and occurs as a result of energy absorption from successive RF pulses, causing pulsed thermal expansion of the head tissues ([ICNIRP, 2009a](#)). [ICNIRP \(1998\)](#) states that repeated or prolonged exposure to microwave auditory effects may be stressful and potentially harmful, and it provides additional guidance for restricting exposures to pulse-modulated fields to avoid this effect.

1.7.2 Basic restrictions

Considering the evidence relating to whole-body heating and localized heating of parts of the body, ICNIRP and IEEE have specified the basic restriction quantities shown in [Table 1.15](#). The information presented here is a summary of the main aspects of the restrictions in the guidelines and serves to provide a simplified comparison for the purposes of this *Monograph*.

From [Table 1.15](#) it is clear that the various sets of guidelines contain similar restriction values and have many common features. Moreover, the 2005 guidelines from IEEE have brought the ICNIRP and IEEE guidelines even closer: the SAR values are now identical and the residual differences now only pertain to averaging times, definition of the extremities, and the shape of the mass used with localized SAR restrictions.

IEEE and ICNIRP both frame their guidelines in terms of two tiers. The first tier includes a wbSAR value that is a factor of 10 lower than the 4 W/kg mentioned above, while the second tier includes restriction values that are five times lower than those in the first tier. In the case of the ICNIRP guidelines, these tiers are presented as restrictions for exposure of workers (tier 1)

Table 1.16 Basic restrictions on induced current density or induced electric field between 30 kHz and 10 MHz, as taken from the ICNIRP and IEEE exposure guidelines

Body region	Workers/controlled				General public/uncontrolled			
	ICNIRP (1998)^a (mA/m ²)	IEEE (1999)^b (mA/m ²)	IEEE (2005)^c (mV/m)	ICNIRP (2010)^d (mV/m)	ICNIRP (1998)^a (mA/m ²)	IEEE (1999)^b (mA/m ²)	IEEE (2005)^c (mV/m)	ICNIRP (2010)^d (mV/m)
Whole body	-	350	-	270	-	157	-	135
CNS	10	-	-	-	2	-	-	-
Brain	-	-	885	-	-	-	294.5	-
Heart	-	-	5647	-	-	-	5647	-
Extremities	-	-	626.9	-	-	-	626.9	-
Other tissues	-	-	626.9	-	-	-	209.3	-

^a Peak rms current density in mA/m², averaged over 1 cm² area perpendicular to the current direction. Applies to the CNS tissues. Applicable frequency range is 1 kHz to 10 MHz.

^b Peak rms current density in mA/m², averaged over any 1 cm² area of tissue in 1 second. Applies anywhere in the body. Applicable frequency range is 3 kHz to 100 kHz.

^c Peak rms internal electric field in mV/m, averaged over a straight-line segment of 5 mm length, oriented in any direction. The averaging time for an rms measurement is 0.2 s. Applicable frequency range is 3.35 kHz to 5 MHz. Values are rounded to four significant digits.

^d Internal electric field in mV/m, averaged over a contiguous tissue volume of 2 × 2 × 2 mm³. The 99th percentile value of the electric field for a specific tissue should be compared with the basic restriction. Applicable frequency range is 3 kHz to 10 MHz.

CNS, central nervous system; rms, root-mean-square value of the electric field strength

Note: All numbers denote the frequency in kHz; all limits in this frequency range increase linearly with frequency. Limits for contact currents also apply (not shown here).

Compiled by the Working Group

and the general public (tier 2). ICNIRP explains that the lower basic restrictions for exposure of the general public take into account the fact that their age and health status may differ from those of workers. The first tier in the IEEE guidelines is described as for controlled environments (subject to a RF safety programme as prescribed by IEEE) and the second tier as for uncontrolled environments, as accessible to the general public.

Electrical effects caused by stimulation of the peripheral and central nervous system are also considered below 10 MHz, although the maximum sensitivity to these effects occurs at considerably lower frequencies, in the tens of hertz to a few kilohertz region ([ICNIRP, 2010](#)). The guidelines should be referred to for further information about these effects; however, the restrictions are summarized in [Table 1.16](#) for frequencies between 30 kHz and 10 MHz.

1.7.3 Reference levels

The guidelines also contain reference levels (called maximum permissible exposures, or MPEs, by IEEE) expressed in terms of electric- and magnetic-field strengths, or plane-wave equivalent power-density incident on the body (see Glossary). Measured or calculated values can be compared with these quantities to verify that the basic restrictions on SAR or induced current/electric fields are not exceeded.

References

- ABS; Australian Bureau of Statistics (2009). *Children's Participation in Culture and Leisure Activities, Australia*. ABS (cat. no. 4901.0). Available at: <http://www.abs.gov.au>
- Adair RK (2002). Vibrational resonances in biological systems at microwave frequencies. *Biophys J*, 82: 1147–1152. doi:10.1016/S0006-3495(02)75473-8 PMID:11867434
- Adair RK (2003). Biophysical limits on athermal effects of RF and microwave radiation. *Bioelectromagnetics*, 24: 39–48. doi:10.1002/bem.10061 PMID:12483664
- Adey WR, Byus CV, Cain CD *et al.* (1999). Spontaneous and nitrosourea-induced primary tumors of the central nervous system in Fischer 344 rats chronically exposed to 836 MHz modulated microwaves. *Radiat Res*, 152: 293–302. doi:10.2307/3580329 PMID:10453090
- AFSSET (2010). *Evaluation des risques sanitaires liés à l'utilisation du scanner corporel à ondes 'millimétriques'*. Provision 100. Agence Française de Sécurité Sanitaire de l'Environnement et du Travail. Rapport d'Expertise Collective, février 2010.
- AGNIR (2001). *Possible health effects from terrestrial trunked radio (TETRA)*. Report of an Advisory Group on Non-ionising Radiation. Documents of the NRPB, 12(2). Available at: www.hpa.org.uk.
- AGNIR (2003). *Health effects from radiofrequency electromagnetic fields. Report of an independent Advisory Group on Non-ionising Radiation*. Documents of the NRPB, 14(2). Available at: www.hpa.org.uk.
- Alanko T & Hietanen M (2007). Occupational exposure to radiofrequency fields in antenna towers. *Radiat Prot Dosimetry*, 123: 537–539. doi:10.1093/rpd/ncl505 PMID:17166878
- Allen SG (1999). Rapporteur report: Sources and exposure metrics from RF epidemiology (Part 1). *Radiat Prot Dosimetry*, 83: 143–147.
- Allen SG, Blackwell RP, Chadwick PJ (1994). Review of occupational exposure to optical radiation and electric and magnetic fields with regard to the proposed CEC Physical Agents Directive, Chilton. *NRPB*, R265: 1–68.
- Allis JW & Sinha-Robinson BL (1987). Temperature-specific inhibition of human red cell Na⁺/K⁺ ATPase by 2,450-MHz microwave radiation. *Bioelectromagnetics*, 8: 203–212. doi:10.1002/bem.2250080211 PMID:3040008
- Andersen JB, Nielsen JO, Pedersen GF *et al.* (2007). Room electromagnetics. *Antennas and Propagation Magazine, IEEE*, 49: 27–33. doi:10.1109/MAP.2007.376642
- Anderson V (2003). Comparisons of peak SAR levels in concentric sphere head models of children and adults for irradiation by a dipole at 900 MHz. *Phys Med Biol*, 48: 3263–3275. doi:10.1088/0031-9155/48/20/001 PMID:14620057
- ANFR (2004). Protocol de mesure in situ. Technical Report 2.1, Agence National de Frequence.
- ANSI/IEEE (1991). C95.1, *IEEE Standard for Safety Levels with Respect to Human Exposure to Radio Frequency Electromagnetic Fields, 3kHz to 300 GHz*. New York, NY.
- ANSI/IEEE (2002a). C95.3, *Recommended Practice for Measurements and Computations of Radio Frequency Electromagnetic Fields With Respect to Human Exposure to Such Fields, 100kHz–300GHz*. New York, NY: International Committee on Electromagnetic Safety, The Institute of Electrical and Electronics Engineers Inc.
- ANSI/IEEE (2002b). C95.6, *IEEE Standard for Safety Levels with Respect to Human Exposure to Electromagnetic fields, 0–3 kHz*. New York, NY.
- Aslan E (1970). Electromagnetic radiation survey meter. *IEEE Trans Instrum Meas*, IM-19: 368–372. doi:10.1109/TIM.1970.4313930
- Aydin D, Feychting M, Schüz J *et al.* (2011). Impact of random and systematic recall errors and selection bias in case-control studies on mobile phone use and brain tumors in adolescents (CEFALO study). *Bioelectromagnetics*, 32: 396–407. doi:10.1002/bem.20651 PMID:21294138
- Baba M, Suzuki Y, Taki M *et al.* (2005). Three dimensional visualization of the temperature distribution in a phantom for the assessment of localized exposure to microwaves In *Bioelectromag*, Soc. Annual Meeting, June 2005, Dublin, Ireland: Bioelectromagnetic Society, pp. 250–251.
- Bakker JF, Paulides MM, Christ A *et al.* (2010). Assessment of induced SAR in children exposed to electromagnetic plane waves between 10 MHz and 5.6 GHz. [Epub.] *Phys Med Biol*, 55: 3115–3130.
- Balzano Q (2003). RF nonlinear interactions in living cells–II: detection methods for spectral signatures. *Bioelectromagnetics*, 24: 483–488. doi:10.1002/bem.10125 PMID:12955753
- Balzano Q, Chou CK, Cicchetti R *et al.* (2000). An efficient RF exposure system with precise whole-body average SAR determination for in vivo animal studies at 900 MHz. *IEEE Trans Microw Theory Tech*, 48: 2040–2049. doi:10.1109/22.884193
- Balzano Q & Sheppard A (2003). RF nonlinear interactions in living cells–I: nonequilibrium thermodynamic theory. *Bioelectromagnetics*, 24: 473–482. doi:10.1002/bem.10126 PMID:12955752
- Bangay Z & Zombolas C (2003). Advanced measurement of microwave oven leakage. *Radiat Prot Australas*, 19: 47–51.
- Bassen H, Herman W, Hoss R (1977). EM probe with fiber optic telemetry system. *Microwave J*, 20: 35–47.
- Bassen H, Swicord M, Abita J (1975). A miniature broadband electric field probe. *Annals of the New York*

- Academy of Sciences *Biological Effects of Nonionizing Radiation*, 247: 481–493.
- Bassen HI & Smith GS (1983). Electric field probes - A review. *IEEE Trans Antenn Propag*, 31: 710–718. doi:10.1109/TAP.1983.1143126
- Baste V, Mild KH, Moen BE (2010). Radiofrequency exposure on fast patrol boats in the Royal Norwegian Navy—an approach to a dose assessment. *Bioelectromagnetics*, 31: 350–360. doi:10.1002/bem.20562 PMID:20054844
- Beard B, Kainz W, Onishi T *et al.* (2006). Comparisons of computed mobile phone induced SAR in the SAM phantom to that in anatomically correct models of the human head. *IEEE Trans Electromagn Compat*, 48: 397–407. doi:10.1109/TEMC.2006.873870
- Beiser A (1995). *Concepts of modern physics*, 5th ed. New York: McGraw-Hill
- Belyaev IY (2010). *Dependence of non-thermal biological effects of microwaves on physical and biological variables: implications for reproducibility and safety standards*. In: *Non-thermal effects and mechanisms of interaction between electromagnetic fields and living matter*. ICEMS Monograph, Giuliani L, Soffritti M, editors. Bologna, Italy: National Institute for the Study and Control of Cancer and Environmental Diseases “Bernardino Ramazzini”, pp. 187–217.
- Bernardi P, Cavagnaro M, Pisa S, Piuze E (2003). Specific absorption rate and temperature elevation in a subject exposed in the far-field of radio-frequency sources operating in the 10–900-MHz range. *IEEE Trans Biomed Eng*, 50: 295–304. doi:10.1109/TBME.2003.808809 PMID:12669986
- Binhi VN & Rubin AB (2007). Magnetobiology: the kT paradox and possible solutions. *Electromagn Biol Med*, 26: 45–62. doi:10.1080/15368370701205677 PMID:17454082
- Bit-Babik G, Guy AW, Chou CK *et al.* (2005). Simulation of exposure and SAR estimation for adult and child heads exposed to radiofrequency energy from portable communication devices. *Radiat Res*, 163: 580–590. doi:10.1667/RR3353 PMID:15850420
- Blackman CF, Benane SG, House DE (1991). The influence of temperature during electric- and magnetic-field-induced alteration of calcium-ion release from in vitro brain tissue. *Bioelectromagnetics*, 12: 173–182. doi:10.1002/bem.2250120305 PMID:1854354
- Blackman CF, Kinney LS, House DE, Joines WT (1989). Multiple power-density windows and their possible origin. *Bioelectromagnetics*, 10: 115–128. doi:10.1002/bem.2250100202 PMID:2540755
- Bornkessel C, Schubert M, Wuschek M, Schmidt P (2007). Determination of the general public exposure around GSM and UMTS base stations. *Radiat Prot Dosimetry*, 124: 40–47. doi:10.1093/rpd/ncm373 PMID:17933788
- Boutry CM, Kuehn S, Achermann P *et al.* (2008). Dosimetric evaluation and comparison of different RF exposure apparatuses used in human volunteer studies. *Bioelectromagnetics*, 29: 11–19. doi:10.1002/bem.20356 PMID:17694536
- Breckenkamp J, Neitzke HP, Bornkessel C, Berg-Beckhoff G (2008). Applicability of an exposure model for the determination of emissions from mobile phone base stations. *Radiat Prot Dosimetry*, 131: 474–481. doi:10.1093/rpd/ncn201 PMID:18676976
- Buddhikot MM, Kennedy I, Mullany F, Viswanathan H (2009). Ultra-broadband femtocells via opportunistic reuse of multi-operator and multi-service spectrum *Bell Labs Technical Journal*, 13: 129–144. doi:10.1002/bltj.20340
- Bürgi A, Theis G, Siegenthaler A, Rösli M (2008). Exposure modeling of high-frequency electromagnetic fields. *J Expo Sci Environ Epidemiol*, 18: 183–191. doi:10.1038/sj.jes.7500575 PMID:17410112
- Burkhardt M, Poković K, Gnos M *et al.* (1996). Numerical and experimental dosimetry of Petri dish exposure setups. *Bioelectromagnetics*, 17: 483–493. doi:10.1002/(SICI)1521-186X(1996)17:6<483::AID-BEM8>3.0.CO;2-# PMID:8986366
- Cardis E, Armstrong BK, Bowman JD *et al.* (2011a). Risk of brain tumours in relation to estimated RF dose from mobile phones: results from five Interphone countries. *Occup Environ Med*, 68: 631–640. doi:10.1136/oemed-2011-100155 PMID:21659469
- Cardis E, Varsier N, Bowman JD *et al.* (2011b). Estimation of RF energy absorbed in the brain from mobile phones in the Interphone Study. *Occup Environ Med*, 68: 686–693. doi:10.1136/oemed-2011-100065 PMID:21659468
- CENELEC (2001). *Basic standard for the measurement of Specific Absorption Rate related to human exposure to electromagnetic fields from mobile phones (300 MHz–3 GHz)*, EN50361.
- CENELEC (2005). *Basic standard to demonstrate the compliance of fixed equipment for radio transmission (110 MHz - 40 GHz) intended for use in wireless telecommunication networks with the basic restrictions or the reference levels related to general public exposure to radio frequency electromagnetic fields, when put into service*, EN50400.
- CENELEC (2008). *Basic standard for the in-situ measurement of electromagnetic field strength related to human exposure in the vicinity of base stations*. CLC/TC 106X, EN50492.
- Challis LJ (2005). Mechanisms for interaction between RF fields and biological tissue. *Bioelectromagnetics*, 26: S7S98–S106. doi:10.1002/bem.20119 PMID:15931683
- Chavannes N, Tay N, Nikoloski N, Kuster N (2003). Suitability of FDTD based TCAD tools for RF design of mobile phones. *IEEE Antennas and Propagation Magazine*, 45: 52–66. doi:10.1109/MAP.2003.1282180
- Chiabrera A, Bianco B, Moggia E, Kaufman JJ (2000). Zeeman-Stark modeling of the RF EMF interaction with ligand binding. *Bioelectromagnetics*, 21: 312–324.

- doi:10.1002/(SICI)1521-186X(200005)21:4<312::AID-BEM7>3.0.CO;2-# PMID:10797459
- Chou CK & Guy AW (1982). Systems for exposing mice to 2,450-MHz electromagnetic fields. *Bioelectromagnetics*, 3: 401–412. doi:10.1002/bem.2250030403 PMID:7181963
- Christ A, Gosselin MC, Christopoulou M *et al.* (2010a). Age-dependent tissue-specific exposure of cell phone users. *Phys Med Biol*, 55: 1767–1783. doi:10.1088/0031-9155/55/7/001 PMID:20208098
- Christ A, Kainz W, Hahn EG *et al.* (2010b). The Virtual Family—development of surface-based anatomical models of two adults and two children for dosimetric simulations. *Phys Med Biol*, 55: N23–N38. doi:10.1088/0031-9155/55/2/N01 PMID:20019402
- Christ A & Kuster N (2005). Differences in RF energy absorption in the heads of adults and children. *Bioelectromagnetics*, 26: Suppl 7S31–S44. doi:10.1002/bem.20136 PMID:16142771
- Christ A, Samaras T, Klingenberg A, Kuster N (2006). Characterization of the electromagnetic near-field absorption in layered biological tissue in the frequency range from 30 MHz to 6,000 MHz. *Phys Med Biol*, 51: 4951–4965. doi:10.1088/0031-9155/51/19/014 PMID:16985280
- Christ A, Samaras T, Neufeld E *et al.* (2007). SAR distribution in human beings when using body-worn RF transmitters. *Radiat Prot Dosimetry*, 124: 6–14. doi:10.1093/rpd/ncm377 PMID:17652110
- Conil E, Hadjem A, Lacroux F *et al.* (2008). Variability analysis of SAR from 20 MHz to 2.4 GHz for different adult and child models using finite-difference time-domain. *Phys Med Biol*, 53: 1511–1525. doi:10.1088/0031-9155/53/6/001 PMID:18367785
- Cooper TG (2002). NRPB-W24 Report “Occupational Exposure to Electric Magnetic Fields in the Context of the ICNIRP Guidelines”. National Radiological Protection Board Report.
- Cooper TG, Allen SG, Blackwell RP *et al.* (2004). Assessment of occupational exposure to radiofrequency fields and radiation. *Radiat Prot Dosimetry*, 111: 191–203. doi:10.1093/rpd/nch334 PMID:15266067
- Cooper TG, Mann SM, Khalid M, Blackwell RP (2006). Public exposure to radio waves near GSM microcell and picocell base stations. *J Radiol Prot*, 26: 199–211. doi:10.1088/0952-4746/26/2/005 PMID:16738416
- Cooray V (2003). *The lightning flash*. Power and Energy Series 34. London, UK: The Institution of Engineering and Technology
- Coray R, Krähenbühl P, Riederer M *et al.* (2002). *Immissionen in Salzburg*. Technical report, BAKOM, Switzerland.
- Crawford ML (1974). Generation of standard EM fields using TEM transmission cells. *IEEE Transact EMC*, 16: 189–195.
- deSalles AA, Bulla G, Rodriguez CE (2006). Electromagnetic absorption in the head of adults and children due to mobile phone operation close to the head. *Electromagn Biol Med*, 25: 349–360. doi:10.1080/15368370601054894 PMID:17178592
- Dimbylow P (2005). Resonance behaviour of whole-body averaged specific energy absorption rate (SAR) in the female voxel model, NAOMI. *Phys Med Biol*, 50: 4053–4063. doi:10.1088/0031-9155/50/17/009 PMID:16177529
- Dimbylow P (2007a). SAR in the mother and foetus for RF plane wave irradiation. *Phys Med Biol*, 52: 3791–3802. doi:10.1088/0031-9155/52/13/009 PMID:17664577
- Dimbylow P & Bolch W (2007b). Whole-body-averaged SAR from 50 MHz to 4 GHz in the University of Florida child voxel phantoms. *Phys Med Biol*, 52: 6639–6649. doi:10.1088/0031-9155/52/22/006 PMID:17975288
- Dimbylow PJ (1997). FDTD calculations of the whole-body averaged SAR in an anatomically realistic voxel model of the human body from 1 MHz to 1 GHz. *Phys Med Biol*, 42: 479–490. doi:10.1088/0031-9155/42/3/003 PMID:9080530
- Dimbylow PJ (2002). Fine resolution calculations of SAR in the human body for frequencies up to 3 GHz. *Phys Med Biol*, 47: 2835–2846. doi:10.1088/0031-9155/47/16/301 PMID:12222849
- Dimbylow PJ, Khalid M, Mann S (2003). Assessment of specific energy absorption rate (SAR) in the head from a TETRA handset. *Phys Med Biol*, 48: 3911–3926. doi:10.1088/0031-9155/48/23/008 PMID:14703166
- Dimbylow PJ, Nagaoka T, Xu XG (2009). A comparison of foetal SAR in three sets of pregnant female models. *Phys Med Biol*, 54: 2755–2767. doi:10.1088/0031-9155/54/9/011 PMID:19369706
- Djafarzadeh R, Crespo-Valero P, Zefferer M *et al.* (2009). *Organ and cns tissue region specific evaluation of the time-averaged far-field exposure in various human body models*. In: *Abstract Collection of BioEM 2009 Davos, the Joint Meeting of the Bioelectromagnetics Society and the European BioElectromagnetics Association*, June 14–19, Davos, Switzerland. Poster presentation P-28 in Poster session 2: Dosimetry (June 16).
- Ebert S (2009). *EMF Risk Assessment: Exposure Systems for Large-Scale Laboratory and Experimental Provocation Studies*. ETH Zurich, Diss. ETH No. 18636, p. 212
- European Commission (2010). *Communication from the Commission to the European Parliament and the Council on the use of security scanners at EU airports*. COM (2010) 311 Final.
- European Telecommunications Standards Institute (2010). *Digital Enhanced Cordless Telecommunications (DECT)*. ETSI-EN300175–2 V2.3.1. Sophia Antipolis Cedex, France: ETSI.
- Fernández C, Bulla G, Pedra A, de Salles A (2005). *Comparison of Electromagnetic Absorption Characteristics in the Head of Adult and a Children for*

- 1800 MHz Mobile Phones, IEEE MTT-S Conference, July 25–28, pp. 523–526.
- Findlay RP & Dimbylow PJ (2005). Effects of posture on FDTD calculations of specific absorption rate in a voxel model of the human body. *Phys Med Biol*, 50: 3825–3835. doi:10.1088/0031-9155/50/16/011 PMID:16077229
- Findlay RP & Dimbylow PJ (2010). SAR in a child voxel phantom from exposure to wireless computer networks (Wi-Fi). *Phys Med Biol*, 55: N405–N411. doi:10.1088/0031-9155/55/15/N01 PMID:20647607
- Findlay RP, Lee AK, Dimbylow PJ (2009). FDTD calculations of SAR for child voxel models in different postures between 10 MHz and 3 GHz. *Radiat Prot Dosimetry*, 135: 226–231. doi:10.1093/rpd/ncp118 PMID:19589878
- Fink JM, Wagner JP, Congleton JJ, Rock JC (1999). Microwave emissions from police radar. *Am Ind Hyg Assoc J*, 60: 770–776. PMID:10671181
- Finkel T (2003). Oxidant signals and oxidative stress. *Curr Opin Cell Biol*, 15: 247–254. doi:10.1016/S0955-0674(03)00002-4 PMID:12648682
- Fixsen D (2009). The temperature of the cosmic microwave background. *Astrophys J*, 707: 916–920. doi:10.1088/0004-637X/707/2/916
- Foster KR (2000). Thermal and nonthermal mechanisms of interaction of radio-frequency energy with biological systems. *IEEE Trans Plasma Sci*, 28: 15–23. doi:10.1109/27.842819
- Foster KR (2007). Radiofrequency exposure from wireless LANs utilizing Wi-Fi technology. *Health Phys*, 92: 280–289. doi:10.1097/01.HP.0000248117.74843.34 PMID:17293700
- Foster KR & Glaser R (2007). Thermal mechanisms of interaction of radiofrequency energy with biological systems with relevance to exposure guidelines. *Health Phys*, 92: 609–620. doi:10.1097/01.HP.0000262572.64418.38 PMID:17495663
- Frei P, Mohler E, Bürgi A *et al.*; QUALIFEX team (2009a). A prediction model for personal radio frequency electromagnetic field exposure. *Sci Total Environ*, 408: 102–108. doi:10.1016/j.scitotenv.2009.09.023 PMID:19819523
- Frei P, Mohler E, Neubauer G *et al.* (2009b). Temporal and spatial variability of personal exposure to radio frequency electromagnetic fields. *Environ Res*, 109: 779–785. doi:10.1016/j.envres.2009.04.015 PMID:19476932
- Fröhlich H (1968). Long range coherence and energy storage in biological systems. *Int J Quantum Chem*, 2: 641–649. doi:10.1002/qua.560020505
- Fujimoto M, Hirata A, Wang J *et al.* (2006). FDTD-Derived Correlation of Maximum Temperature Increase and Peak SAR in Child and Adult Head Models Due to Dipole Antenna *IEEE Trans Electromagn Compat*, 48: 240–247. doi:10.1109/TEMC.2006.870816
- Gabriel C (2005). Dielectric properties of biological tissue: variation with age. *Bioelectromagnetics*, 26: Suppl 7S12–S18. doi:10.1002/bem.20147 PMID:16142779
- Gajsek P, D'Andrea JA, Mason PA *et al.* (2003). *Mathematical modelling using experimental and theoretical methods*. In: *Biological effects of Electromagnetic Fields*. Stavroulakis P, editor. Springer Verlag, pp. 118–170. [to be found in Google Books]
- Gandhi OP, Lazzi G, Tinniswood A, Yu QS (1999). Comparison of numerical and experimental methods for determination of SAR and radiation patterns of handheld wireless telephones. *Bioelectromagnetics*, 4: Suppl 493–101. doi:10.1002/(SICI)1521-186X(1999)20:4+<93::AID-BEM11>3.0.CO;2-8 PMID:10334718
- Gati A, Hadjem A, Wong M-F, Wiart J (2009). Exposure induced by WCDMA mobiles phones in operating networks. *IEEE Trans Wirel Comm*, 8: 5723–5727. doi:10.1109/TWC.2009.12.080758
- Georgiou CD (2010). *Oxidative stress-induced biological damage by low-level EMFs: mechanism of free radical pair electron-spin polarization and biochemical amplification*. In: *Non-thermal effects and mechanisms of interaction between electromagnetic fields and living matter*. ICEMS Monograph, Giuliani L, Soffritti M, editors. Bologna, Italy: National Institute for the Study and Control of Cancer and Environmental Diseases “Bernardino Ramazzini”, pp. 63–113.
- Gosselin MC, Christ A, Kühn S, Kuster N (2009). Dependence of the Occupational Exposure to Mobile Phone Base Stations on the Properties of the Antenna and the Human Body. *IEEE Trans Electromagn Compat*, 51: 227–235. doi:10.1109/TEMC.2009.2013717
- Gosselin MC, Kühn S, Crespo-Valero P *et al.* (2011). Estimation of head tissue-specific exposure from mobile phones based on measurements in the homogeneous SAM head. *Bioelectromagnetics*, n/a doi:10.1002/bem.20662 PMID:21416476
- Guy AW (1971). Analyses of electromagnetic fields induced in biological tissue by thermographic studies on equivalent phantom models. *IEEE Trans Microw Theory Tech*, 34: 671–680. doi:10.1109/TMTT.1986.1133416
- Guy AW, Wallace J, McDougall JA (1979). Circular polarized 2450-MHz waveguide system for chronic exposure of small animals to microwaves. *Radio Sci*, 14: 6S63–74. doi:10.1029/RS014i06Sp00063
- Hadjem A, Lautru D, Dale C *et al.* (2005a). Study of specific absorption rate (sar) induced in the two child head models and adult heads using a mobile phone *IEEE Trans MTT*, 53: 4–11. doi:10.1109/TMTT.2004.839343
- Hadjem A, Lautru D, Gadi N *et al.* (2005b). *Influence of the ear's morphology on Specific Absorption Rate (SAR) Induced in a Child Head using two source models*. IEEE MTT-S Conference, June 12–17.

- Hansen VW, Bitz AK, Streckert JR (1999). RF exposure of biological systems in radial waveguides. *IEEE Transact EMC*, 41: 487–493.
- Heinävaara S, Tokola K, Kurttio P, Auvinen A (2011). Validation of exposure assessment and assessment of recruitment methods for a prospective cohort study of mobile phone users (COSMOS) in Finland: a pilot study. *Environ Health*, 10: 14 doi:10.1186/1476-069X-10-14 PMID:21385407
- Henbest KB, Kukura P, Rodgers CT *et al.* (2004). Radio frequency magnetic field effects on a radical recombination reaction: a diagnostic test for the radical pair mechanism. *J Am Chem Soc*, 126: 8102–8103. doi:10.1021/ja048220q PMID:15225036
- Henderson SI & Bangay MJ (2006). Survey of RF exposure levels from mobile telephone base stations in Australia. *Bioelectromagnetics*, 27: 73–76. doi:10.1002/bem.20174 PMID:16283652
- Herring S (2004). Slouching toward the ordinary: current trends in computer-mediated communication. *New Media Soc*, 6: 26–36. doi:10.1177/1461444804039906
- Hillert L, Ahlbom A, Neasham D *et al.* (2006). Call-related factors influencing output power from mobile phones. *J Expo Sci Environ Epidemiol*, 16: 507–514. doi:10.1038/sj.jes.7500485 PMID:16670713
- Hirata A, Fujimoto M, Asano T *et al.* (2006a). Correlation between maximum temperature increase and peak SAR with different average schemes and masses *IEEE Trans Electromagn Compat*, 48: 569–578. doi:10.1109/TEMC.2006.877784
- Hirata A, Fujiwara O, Shiozawa T (2006b). Correlation between peak spatial-average SAR and temperature increase due to antennas attached to human trunk. *IEEE Trans Biomed Eng*, 53: 1658–1664. doi:10.1109/TBME.2006.877798 PMID:16916100
- Hirata A, Ito N, Fujiwara O (2009). Influence of electromagnetic polarization on the whole-body averaged SAR in children for plane-wave exposures. *Phys Med Biol*, 54: N59–N65. doi:10.1088/0031-9155/54/4/N02 PMID:19141885
- Hirata A, Morita M, Shiozawa T (2003). Temperature increase in the human head due to a dipole antenna at microwave frequencies. *IEEE Trans Electromagn Compat*, 45: 109–116. doi:10.1109/TEMC.2002.808045
- Hirata A, Shirai K, Fujiwara O (2008). On averaging mass of SAR correlating with temperature elevation due to a dipole antenna *Progr. Electrom. Research*, 84: 221–237. doi:10.2528/PIER08072704
- Hombach V, Meier K, Burkhardt M *et al.* (1996). The dependence of EM energy absorption upon human head modeling at 900 MHz. *IEEE Trans Microw Theory Tech*, 44: 1865–1873. doi:10.1109/22.539945
- HPA (2008). Report on MRI
- Hurt WD, Ziriaux JM, Mason PA (2000). Variability in EMF permittivity values: implications for SAR calculations. *IEEE Trans Biomed Eng*, 47: 396–401. doi:10.1109/10.827308 PMID:10743782
- IARC (2002). Non-ionizing radiation, Part 1: static and extremely low-frequency (ELF) electric and magnetic fields. *IARC Monogr Eval Carcinog Risks Hum*, 80: 1–395. PMID:12071196
- ICNIRP; International Commission on Non-Ionizing Radiation Protection (1998). Guidelines for limiting exposure to time-varying electric, magnetic, and electromagnetic fields (up to 300 GHz). *Health Phys*, 74: 494–522. PMID:9525427.
- ICNIRP; International Commission on Non-Ionizing Radiation Protection (2009a). Exposure to high frequency electromagnetic fields, biological effects and health consequences (100 kHz to 300 GHz). la Vecchia P, Matthes R, Ziegelberger G *et al.*, editors. pp. 1–392. Available at: <http://www.icnirp.de/>
- ICNIRP; International Commission on Non-Ionizing Radiation Protection (2009b). Statement on the guidelines for limiting exposure to time varying electric, magnetic, and electromagnetic fields (up to 300 ghz) *Health Phys*, 97: 257–258.
- ICNIRP; International Commission on Non-Ionizing Radiation Protection (2010). Guidelines for limiting exposure to time-varying electric and magnetic fields (1 Hz to 100 kHz). *Health Phys*, 99: 818–836. PMID:21068601
- IEEE (1999). *Standard for Safety Levels with Respect to Human Exposure to Radio Frequency Electromagnetic Fields, 3 KHz to 300 GHz, C95, 1*.
- IEEE (2003). *Recommended Practice for Determining the Spatial-Peak Specific Absorption Rate (SAR) in the Human Body Due to Wireless Communications Devices: Measurement Techniques*, 1528/D1.2. Piscataway, NJ, USA
- IEEE (2005). C95.1, *IEEE Standard for Safety Levels with Respect to Human Exposure to Radio Frequency Electromagnetic Fields, 100 kHz-300 GHz*.
- InfoPlease (2011). Available at: <http://www.infoplease.com/ipa/A0933563.html>
- Inyang I, Benke G, McKenzie R *et al.* (2010). A new method to determine laterality of mobile telephone use in adolescents. *Occup Environ Med*, 67: 507–512. doi:10.1136/oem.2009.049676 PMID:19955574
- Inyang I, Benke G, McKenzie R, Abramson M (2008). Comparison of measuring instruments for radiofrequency radiation from mobile telephones in epidemiological studies: implications for exposure assessment. *J Expo Sci Environ Epidemiol*, 18: 134–141. doi:10.1038/sj.jes.7500555 PMID:17327852
- Inyang I, Benke G, Morrissey J *et al.* (2009). How well do adolescents recall use of mobile telephones? Results of a validation study. *BMC Med Res Methodol*, 9: 36 doi:10.1186/1471-2288-9-36 PMID:19523193
- IPEM (2010). *Guidance on the measurement and use of EMF and EMC*, Report 98. York, UK: Institute of Physics

- and Engineering in Medicine. Available at: <http://www.ipem.ac.uk/publications/ipemreports/Pages/GuidanceontheMeasurementandUseofEMFandEMC.aspx>
- ITU (2008). *Radio Regulations*, Volume 1. International Telecommunication Union. Articles Edition 2008. Available at: <http://www.itu.int/pub/R-REG-RR/en>
- Jaspard F, Nadi M, Rouane A (2003). Dielectric properties of blood: an investigation of haematocrit dependence. *Physiol Meas*, 24: 137–147. doi:10.1088/0967-3334/24/1/310 PMID:12636192
- Jokela K & Puranen L (1999). Occupational RF exposures. *Radiat Prot Dosimetry*, 83: 119–124.
- Jokela K, Puranen L, Gandhi OP (1994). Radio frequency currents induced in the human body for medium-frequency/high-frequency broadcast antennas. *Health Phys*, 66: 237–244. doi:10.1097/00004032-199403000-00001 PMID:8106240
- Jóó E, Szász A, Szendrő P (2006). Metal-framed spectacles and implants and specific absorption rate among adults and children using mobile phones at 900/1800/2100 MHz. *Electromagn Biol Med*, 25: 103–112. doi:10.1080/15368370600719042 PMID:16771299
- Joseph W, Frei P, Roösl M *et al.* (2010). Comparison of personal radio frequency electromagnetic field exposure in different urban areas across Europe. *Environ Res*, 110: 658–663. doi:10.1016/j.envres.2010.06.009 PMID:20638656
- Joseph W, Olivier C, Martens L (2002). A robust, fast and accurate deconvolution algorithm for EM-field measurements around GSM and UMTS base stations with a spectrum analyser. *IEEE Trans Instrum Meas*, 51: 1163–1169. doi:10.1109/TIM.2002.808026
- Joseph W, Verloock L, Martens L (2008). Accurate determination of the electromagnetic field due to wimax base station antennas. *Electromagnetic Compatibility IEEE Transactions*, 50: 730–735.
- Jung KB, Kim TH, Kim JL *et al.* (2008). Development and validation of reverberation-chamber type whole-body exposure system for mobile-phone frequency. *Electromagn Biol Med*, 27: 73–82. doi:10.1080/15368370701878895 PMID:18327716
- Kainz W, Christ A, Kellom T *et al.* (2005). Dosimetric comparison of the specific anthropomorphic mannequin (SAM) to 14 anatomical head models using a novel definition for the mobile phone positioning. *Phys Med Biol*, 50: 3423–3445. doi:10.1088/0031-9155/50/14/016 PMID:16177519
- Kainz W, Nikoloski N, Oesch W *et al.* (2006). Development of novel whole-body exposure setups for rats providing high efficiency, National Toxicology Program (NTP) compatibility and well-characterized exposure (No. 20) *Physics in Medicine and Biology*, 51: 5211–5229. PMID:17019034.
- Kanda M (1993). Standard probes for electromagnetic field measurement. *IEEE Trans Antenn Propag*, AP-41: 1349–1364. doi:10.1109/8.247775
- Kännälä S, Puranen L, Sihvonen AP, Jokela K (2008). Measured and computed induced body currents in front of an experimental RF dielectric heater. *Health Phys*, 94: 161–169. doi:10.1097/01.HP.0000286776.79411.1c PMID:18188050
- Kawai H, Nagaoka T, Watanabe S *et al.* (2010). Computational dosimetry in embryos exposed to electromagnetic plane waves over the frequency range of 10 MHz–1.5 GHz *Phys Med Biol*, 55: 1–11. doi:10.1088/0031-9155/55/1/N01 PMID:19949261
- Kelsh MA, Shum M, Sheppard AR *et al.* (2010). Measured radiofrequency exposure during various mobile-phone use scenarios. *J Expo Sci Environ Epidemiol*, doi:10.1038/jes.2010.12 PMID:20551994
- Keshvari J & Lang S (2005). Comparison of radio frequency energy absorption in ear and eye region of children and adults at 900, 1800 and 2450 MHz. *Phys Med Biol*, 50: 4355–4369. doi:10.1088/0031-9155/50/18/008 PMID:16148398
- Khalid M, Mee T, Peyman A *et al.* (2011). *Exposure to electromagnetic fields from wireless computer networks: duty factor of Wi-Fi devices operating in schools: Non-Ionizing Radiation & Children's Health*. International Joint Workshop, 18–20 May, 2011. Ljubljana, Slovenia.
- Kim BC & Park S-O (2010). Evaluation of RF electromagnetic field exposure levels from cellular base stations in Korea. *Bioelectromagnetics*, 31: 495–498. PMID:20564176
- Kowalczyk C, Yarwood G, Blackwell R *et al.* (2010). Absence of nonlinear responses in cells and tissues exposed to RF energy at mobile phone frequencies using a doubly resonant cavity. *Bioelectromagnetics*, 31: 556–565. doi:10.1002/bem.20597 PMID:20607742
- Kramer A, Müller P, Lott U *et al.* (2006). Electro-optic fiber sensor for amplitude and phase detection of radio frequency electromagnetic fields. *Opt Lett*, 31: 2402–2404. doi:10.1364/OL.31.002402 PMID:16880836
- Kühn S (2009). *EMF Risk Assessment: Exposure Assessment and Compliance Testing in Complex Environments*. Swiss Federal Institute of Technology, Zurich, Switzerland: Hartung-Gorre Verlag Konstanz. PhD thesis, Diss. ETH Nr. 18637, Defense: 29 September 2009, doi:10.3929/ethz-a-006037728.10.3929/ethz-a-006037728
- Kühn S, Cabot E, Christ A *et al.* (2009a). Assessment of the radio-frequency electromagnetic fields induced in the human body from mobile phones used with hands-free kits. *Phys Med Biol*, 54: 5493–5508. doi:10.1088/0031-9155/54/18/010 PMID:19706964
- Kühn S, Gosselin M, Crespo-Valero P, *et al.* (2010). *Cumulative Exposure in Time and Frequency Domains of the Central Nervous System*. Final Report SNF 405740-113591 SNF NRP57 Source for Table 1.6

- Kühn S, Jennings W, Christ A, Kuster N (2009b). Assessment of induced radio-frequency electromagnetic fields in various anatomical human body models. *Phys Med Biol*, 54: 875–890. doi:10.1088/0031-9155/54/4/004 PMID:19141880
- Kühn S, Kuster N (2007). *Experimental EMF exposure assessment*. In: *Handbook of Biological Effects of Electromagnetic Fields*, 3rd ed. Barnes FS, Greenebaum B, editors. Boca Raton: CRC Press.
- Kühn S, Schmid T, Kuster N (2007b). *System specific probe calibration*. Presentation at the IEEE TC-34 / FCC SAR round table meeting, College Park, MD, USA, October 18, 2007.
- Kühn S, Urs Lott S, Kramer A *et al.* (2007a). Assessment methods for demonstrating compliance with safety limits of wireless devices used in home and office environments. *IEEE Trans Electromagn Compat*, 49: 519–525. doi:10.1109/TEMC.2007.903042
- Kuster N & Balzano Q (1992). Energy absorption mechanism by biological bodies in the near field of dipole antennas above 300 MHz. *IEEE Trans Vehicular Technol*, 41: 17–23. doi:10.1109/25.120141
- Kuster N & Schönborn F (2000). Recommended minimal requirements and development guidelines for exposure setups of bio-experiments addressing the health risk concern of wireless communications. *Bioelectromagnetics*, 21: 508–514. doi:10.1002/1521-186X(200010)21:7<508::AID-BEM4>3.0.CO;2-F PMID:11015115
- Kuster N, Schuderer J, Christ A *et al.* (2004). Guidance for exposure design of human studies addressing health risk evaluations of mobile phones. *Bioelectromagnetics*, 25: 524–529. doi:10.1002/bem.20034 PMID:15376239
- Kuster N, Torres VB, Nikoloski N *et al.* (2006). Methodology of detailed dosimetry and treatment of uncertainty and variations for in vivo studies. *Bioelectromagnetics*, 27: 378–391. doi:10.1002/bem.20219 PMID:16615059
- Lee A-K, Byun J-K, Park J-S *et al.* (2009). Development of 7-year-old Korean child model for computational dosimetry *ETRI J*, 31: 237–239. doi:10.4218/etrij.09.0208.0342
- Lee A-K, Choi H-D, Choi J-I (2007). Study on SARs in Head Models With Different Shapes by Age Using SAM Model for Mobile Phone Exposure at 835 MHz. *IEEE Trans Electromagn Compat*, 49: 302–312. doi:10.1109/TEMC.2007.897124
- Lee AK & Yun J (2011). A Comparison of Specific Absorption Rates in SAM Phantom and Child Head Models at 835 and 1900 MHz. *IEEE Trans Electromagn Compat*, 99: 1–9.
- Lee C, Lee C, Park SH, Lee JK (2006). Development of the two Korean adult tomographic computational phantoms for organ dosimetry. *Med Phys*, 33: 380–390. doi:10.1118/1.2161405 PMID:16532944
- Lévêque P, Dale C, Veyret B, Wiart J (2004). Dosimetric analysis of a 900-MHz rat head exposure system. *IEEE Trans Microw Theory Tech*, 52: 2076–2083. doi:10.1109/TMTT.2004.831984
- Liburdy RP & Penn A (1984). Microwave bioeffects in the erythrocyte are temperature and pO₂ dependent: cation permeability and protein shedding occur at the membrane phase transition. *Bioelectromagnetics*, 5: 283–291. doi:10.1002/bem.2250050215 PMID:6732882
- Lin JC (2007). Dosimetric comparison between different quantities for limiting exposure in the RF band: rationale and implications for guidelines. *Health Phys*, 92: 547–553. doi:10.1097/01.HP.0000236788.33488.65 PMID:17495655
- Lönn S, Forssén U, Vecchia P *et al.* (2004). Output power levels from mobile phones in different geographical areas; implications for exposure assessment. *Occup Environ Med*, 61: 769–772. doi:10.1136/oem.2003.012567 PMID:15317918
- Lu Y, Yu J, Ren Y (1994). Dielectric properties of human red blood cells in suspension at radio frequencies. *Bioelectromagnetics*, 15: 589–591. doi:10.1002/bem.2250150612 PMID:7880172
- Mann S (2010). Assessing personal exposures to environmental radiofrequency electromagnetic fields. *C R Phys*, 11: 541–555. doi:10.1016/j.crhy.2010.11.005
- Mantiply ED, Pohl KR, Poppell SW, Murphy JA (1997). Summary of measured radiofrequency electric and magnetic fields (10 kHz to 30 GHz) in the general and work environment. *Bioelectromagnetics*, 18: 563–577. doi:10.1002/(SICI)1521-186X(1997)18:8<563::AID-BEM5>3.0.CO;2-0 PMID:9383245
- Martens L (2005). Electromagnetic safety of children using wireless phones: a literature review. *Bioelectromagnetics*, 26: Suppl 7S133–S137. doi:10.1002/bem.20150 PMID:16059915
- Martínez-Búrdalo M, Martín A, Anguiano M, Villar R (2004). Comparison of FDTD-calculated specific absorption rate in adults and children when using a mobile phone at 900 and 1800 MHz. *Phys Med Biol*, 49: 345–354. doi:10.1088/0031-9155/49/2/011 PMID:15083675
- McIntosh RL & Anderson V (2010). SAR versus S(inc): What is the appropriate RF exposure metric in the range 1–10 GHz? Part II: Using complex human body models. *Bioelectromagnetics*, 31: 467–478. PMID:20354998
- Meyer FJ, Davidson DB, Jakobus U, Stuchly MA (2003). Human exposure assessment in the near field of GSM base-station antennas using a hybrid finite element/method of moments technique. *IEEE Trans Biomed Eng*, 50: 224–233.
- Mezei G, Benyi M, Muller A (2007). Mobile phone ownership and use among school children in three Hungarian cities. *Bioelectromagnetics*, 28: 309–315. doi:10.1002/bem.20270 PMID:17216610
- Moros EG, Straube WL, Pickard WF (1999). The radial transmission line as a broad-band shielded exposure system for microwave irradiation of large numbers

- of culture flasks. *Bioelectromagnetics*, 20: 65–80. doi:10.1002/(SICI)1521-186X(1999)20:2<65::AID-BEM1>3.0.CO;2-W PMID:10029133
- Nagaoka T, Kunieda E, Watanabe S (2008). Proportion-corrected scaled voxel models for Japanese children and their application to the numerical dosimetry of specific absorption rate for frequencies from 30 MHz to 3 GHz. *Phys Med Biol*, 53: 6695–6711. doi:10.1088/0031-9155/53/23/004 PMID:18997264
- Nagaoka T, Togashi T, Saito K *et al.* (2007). An anatomically realistic whole-body pregnant-woman model and specific absorption rates for pregnant-woman exposure to electromagnetic plane waves from 10 MHz to 2 GHz. *Phys Med Biol*, 52: 6731–6745. doi:10.1088/0031-9155/52/22/012 PMID:17975294
- Nagaoka T, Watanabe S (2009). *Estimation of variability of specific absorption rate with physical description of children exposed to electromagnetic field in the VHF band*. International conference of the IEEE EMBS.
- Narda STS (2005). *Electric Field Probe For EMR-200 and EMR-300*. (December 16, 2005). Available at: <http://www.narda-sts.com>.
- NASA (2011). *Sun FactSheet*. National Aeronautics and Space Administration. Available at: <http://nssdc.gsfc.nasa.gov/planetary/factsheet/sunfact.html>
- NCRP; National Council on Radiation Protection and Measurements (1986). *Biological Effects and Exposure Criteria for Radiofrequency Electromagnetic Fields*. NCRP Report 86, Recommendations of the National Council on Radiation Protection and Measurements.
- Neubauer G, Preiner P, Cecil S *et al.* (2009). The relation between the specific absorption rate and electromagnetic field intensity for heterogeneous exposure conditions at mobile communications frequencies. *Bioelectromagnetics*, 30: 651–662. PMID:19551765
- Nielsen (2010). *Media industry fact sheet*. Available at: <http://blog.nielsen.com/nielsenwire/press/nielsen-fact-sheet-2010.pdf>
- Nikoloski N, Fröhlich J, Samaras T *et al.* (2005). Reevaluation and improved design of the TEM cell in vitro exposure unit for replication studies. *Bioelectromagnetics*, 26: 215–224. doi:10.1002/bem.20067 PMID:15768424
- NOAA (2011). *Science on a Sphere: Annual lightning flash rate*. Available at: <http://www.srh.noaa.gov/>
- Olivier C & Martens L (2005). Optimal settings for narrow-band signal measurements used for exposure assessment around GSM base stations. *IEEE Trans Instrum Meas*, 54: 311–317. doi:10.1109/TIM.2004.838114
- Olivier C & Martens L (2006). Theoretical derivation of the stochastic behavior of a WCDMA signal measured with a spectrum analyzer. *IEEE Trans Instrum Meas*, 55: 603–614. doi:10.1109/TIM.2006.870330
- Petersen RC & Testagrossa PA (1992). Radio-frequency electromagnetic fields associated with cellular-radio cell-site antennas. *Bioelectromagnetics*, 13: 527–542. doi:10.1002/bem.2250130608 PMID:1482416
- Peyman A, Gabriel C (2002). *Variation of the dielectric properties of biological tissue as a function of age*. Final Technical Report, Department of Health, UK.
- Peyman A & Gabriel C (2007). Development and characterization of tissue equivalent materials for frequency range 30 – 300 MHz *Electron Lett*, 43: 19–20 doi:10.1049/el:20073455
- Peyman A, Gabriel C, Grant EH *et al.* (2009). Variation of the dielectric properties of tissues with age: the effect on the values of SAR in children when exposed to walkie-talkie devices. *Phys Med Biol*, 54: 227–241. doi:10.1088/0031-9155/54/2/004 PMID:19088390
- Peyman A, Holden SJ, Watts S *et al.* (2007). Dielectric properties of porcine cerebrospinal tissues at microwave frequencies: in vivo, in vitro and systematic variation with age. *Phys Med Biol*, 52: 2229–2245. doi:10.1088/0031-9155/52/8/013 PMID:17404466
- Peyman A, Khalid M, Calderon C *et al.* (2011). Assessment of exposure to electromagnetic fields from wireless computer networks (Wi-Fi) in schools; results of laboratory measurements. *Health Phys*, 100: 594–612. doi:10.1097/HP.0b013e318200e203
- Peyman A, Rezazadeh AA, Gabriel C (2001). Changes in the dielectric properties of rat tissue as a function of age at microwave frequencies. *Phys Med Biol*, 46: 1617–1629. doi:10.1088/0031-9155/46/6/303 PMID:11419623
- Poković K (1999). *Advanced Electromagnetic Probes for Near-Field Evaluations*. PhD thesis, Diss. ETH Nr. 13334, Zurich.
- Poković K, Schmid T, Fröhlich J, Kuster N (2000b). Novel probes and evaluation procedures to assess field magnitude and polarization. *IEEE Trans Electromagn Compat*, 42: 240–245. doi:10.1109/15.852419
- Poković K, Schmid T, Kuster N (2000a). Millimeter-resolution E-field probe for isotropic measurement in lossy media between 100 MHz and 20 GHz. *IEEE Trans Instrum Meas*, 49: 873–878. doi:10.1109/19.863941
- Porter SJ, Capstick MH, Faraci F, Flintoft ID (2005). *AR testing of hands-free mobile telephones*. *Mobile Telecommunications and Health Research Programme*. Available at: [http://www.mthr.org.uk/research_projects/dti_funded_projects/porter\(sar\).htm](http://www.mthr.org.uk/research_projects/dti_funded_projects/porter(sar).htm)
- SProhofsky EW (2004). RF absorption involving biological macromolecules. *Bioelectromagnetics*, 25: 441–451. doi:10.1002/bem.20013 PMID:15300730
- Redmayne M, Inyang I, Dimitriadis C *et al.* (2010). Cordless telephone use: implications for mobile phone research. *J Environ Monit*, 12: 809–812. doi:10.1039/b920489j PMID:20383359
- Repacholi MH (2001). Health risks from the use of mobile phones. *Toxicol Lett*, 120: 323–331. doi:10.1016/S0378-4274(01)00285-5 PMID:11323191
- Ritz T, Wiltshko R, Hore PJ *et al.* (2009). Magnetic compass of birds is based on a molecule with optimal directional sensitivity. *Biophys J*, 96: 3451–3457. doi:10.1016/j.bpj.2008.11.072 PMID:19383488

- Rudge AW (1970). An electromagnetic radiation probe for near-field measurements at microwave frequencies. *J Microw Power*, 5: 155–174.
- Samaras T, Kalampaliki E, Sahalos JN (2007). Influence of Thermophysiological Parameters on the Calculation of Temperature Rise in the Head of Mobile Phone Users *IEEE Trans Electromagn Compat*, 49: 936–939. doi:10.1109/TEMC.2007.908257
- Schmid G, Lager D, Preiner P *et al.* (2007b). Exposure caused by wireless technologies used for short-range indoor communication in homes and offices. *Radiat Prot Dosimetry*, 124: 58–62. doi:10.1093/rpd/ncm245 PMID:17566000
- Schmid G, Neubauer G, Illievich UM, Alesch F (2003). Dielectric properties of porcine brain tissue in the transition from life to death at frequencies from 800 to 1900 MHz. *Bioelectromagnetics*, 24: 413–422. doi:10.1002/bem.10122 PMID:12929160
- Schmid G, Preiner P, Lager D *et al.* (2007a). Exposure of the general public due to wireless LAN applications in public places. *Radiat Prot Dosimetry*, 124: 48–52. doi:10.1093/rpd/ncm320 PMID:17562659
- Schmid G & Überbacher R (2005). Age dependence of dielectric properties of bovine brain and ocular tissues in the frequency range of 400 MHz to 18 GHz. *Phys Med Biol*, 50: 4711–4720. doi:10.1088/0031-9155/50/19/019 PMID:16177499
- Schönborn F, Burkhardt M, Kuster N (1998). Differences in energy absorption between heads of adults and children in the near field of sources. *Health Phys*, 74: 160–168. doi:10.1097/00004032-199802000-00002 PMID:9450585
- Schubert M, Bornkessel C, Wuschek M, Schmidt P (2007). Exposure of the general public to digital broadcast transmitters compared to analogue ones. *Radiat Prot Dosimetry*, 124: 53–57. doi:10.1093/rpd/ncm337 PMID:17617635
- Schuderer J, Schmid T, Urban G *et al.* (2004a). Novel high-resolution temperature probe for radiofrequency dosimetry. *Phys Med Biol*, 49: N83–N92. doi:10.1088/0031-9155/49/6/N04 PMID:15104331
- Schuderer J, Spät D, Samaras T *et al.* (2004b). In Vitro Exposure Systems for RF Exposures at 900 MHz. *IEEE Trans Microw Theory Tech*, 52: 2067–2075. doi:10.1109/TMTT.2004.832010
- Schüz J (2009). Lost in laterality: interpreting “preferred side of the head during mobile phone use and risk of brain tumour” associations. *Scand J Public Health*, 37: 664–667. doi:10.1177/1403494809341096 PMID:19581357
- Schüz J & Mann S (2000). A discussion of potential exposure metrics for use in epidemiological studies on human exposure to radiowaves from mobile phone base stations. *J Expo Anal Environ Epidemiol*, 10: 600–605. doi:10.1038/sj.jea.7500115 PMID:11140443
- Seibersdorf Research (2011). *Precision Conical Dipole PCD 8250*. Available at: <http://www.seibersdorf-laboratories.at>
- Sektion NIS (2002). *BUWAL und Sektion Hochfrequenz, EMV und Verkehr*. Mobilfunk-Basisstationen (GSM). Messempfehlung. February 2002.
- Sheppard AR, Swicord ML, Balzano Q (2008). Quantitative evaluations of mechanisms of radiofrequency interactions with biological molecules and processes. *Health Phys*, 95: 365–396. doi:10.1097/01.HP.0000319903.20660.37 PMID:18784511
- Shum M, Kelsh MA, Sheppard AR, Zhao K (2011). An evaluation of self-reported mobile phone use compared to billing records among a group of engineers and scientists. *Bioelectromagnetics*, 32: 37–48. doi:10.1002/bem.20613 PMID:20857456
- Singal T (2010). *Wireless communications*. New Delhi: Tata McGraw Hill Education Private Limited.
- Smith GS (1981). Analysis of miniature electric field probes with resistive transmission lines. *IEEE Trans Microw Theory Tech*, MTT-29: 1213–1224. doi:10.1109/TMTT.1981.1130534
- Stuchly MA (1979). Interaction of radiofrequency and microwave radiation with living systems. A review of mechanisms. *Radiat Environ Biophys*, 16: 1–14. doi:10.1007/BF01326892 PMID:382232
- Taurisano MD & Vander Vorst A (2000). Experimental thermographic analysis of thermal effects induced on a human head exposed to 900 MHz fields of mobile-phones. *IEEE Trans Microw Theory Tech*, 48: 2022–2032. doi:10.1109/22.884191
- Thurai M, Goodridge VD, Sheppard RJ, Grant EH (1984). Variation with age of the dielectric properties of mouse brain cerebrum. *Phys Med Biol*, 29: 1133–1136. doi:10.1088/0031-9155/29/9/009 PMID:6483977
- Thurai M, Steel MC, Sheppard RJ, Grant EH (1985). Dielectric properties of developing rabbit brain at 37 degrees C. *Bioelectromagnetics*, 6: 235–242. doi:10.1002/bem.2250060304 PMID:3836667
- Timmel CR, Till U, Brocklehurst B *et al.* (1998). Effects of weak magnetic fields on free radical recombination reactions. *Mol Phys*, 95: 71–89. doi:10.1080/00268979809483134
- Tinniswood AD, Furse CM, Gandhi OP (1998). Power deposition in the head and neck of an anatomically based human body model for plane wave exposures. *Phys Med Biol*, 43: 2361–2378. doi:10.1088/0031-9155/43/8/026 PMID:9725610
- Togashi T, Nagaoka T, Kikuchi S *et al.* (2008). TDTD calculations of specific absorption rate in fetus caused by electromagnetic waves from mobile radio terminal using pregnant woman model. *IEEE Trans Microw Theory Tech*, 56: 554–559. doi:10.1109/TMTT.2007.914625
- Togo H, Shimizu N, Nagatsuma T (2007). Near-field mapping system using fiber-based electro-optic probe

- for specific absorption rate measurement *IEICE Trans Electron*, 90: C436–442. doi:10.1093/ietele/e90-c.2.436
- Tomitsch J, Dechant E, Frank W (2010). Survey of electromagnetic field exposure in bedrooms of residences in lower Austria. *Bioelectromagnetics*, 31: 200–208. PMID:19780092
- Uusitupa T, Laakso I, Ilvonen S, Nikoskinen K (2010). SAR variation study from 300 to 5000 MHz for 15 voxel models including different postures. *Phys Med Biol*, 55: 1157–1176. doi:10.1088/0031-9155/55/4/017 PMID:20107250
- Valberg PA (1995). Designing EMF experiments: what is required to characterize “exposure”? *Bioelectromagnetics*, 16: 396–401, discussion 402–406. doi:10.1002/bem.2250160608 PMID:8789071
- Van Leeuwen GM, Lagendijk JJ, Van Leersum BJ *et al.* (1999). Calculation of change in brain temperatures due to exposure to a mobile phone. *Phys Med Biol*, 44: 2367–2379. doi:10.1088/0031-9155/44/10/301 PMID:10533916
- Vermeeren G, Gosselin MC, Kühn S *et al.* (2010). The influence of the reflective environment on the absorption of a human male exposed to representative base station antennas from 300 MHz to 5 GHz. *Phys Med Biol*, 55: 5541–5555. doi:10.1088/0031-9155/55/18/018 PMID:20808028
- Vermeeren G, Joseph W, Olivier C, Martens L (2008). Statistical multipath exposure of a human in a realistic electromagnetic environment. *Health Phys*, 94: 345–354. doi:10.1097/01.HP.0000298816.66888.05 PMID:18332726
- Viel JF, Clerc S, Barrera C *et al.* (2009). Residential exposure to radiofrequency fields from mobile phone base stations, and broadcast transmitters: a population-based survey with personal meter. *Occup Environ Med*, 66: 550–556. doi:10.1136/oem.2008.044180 PMID:19336431
- Vrijheid M, Armstrong BK, Bédard D *et al.* (2009b). Recall bias in the assessment of exposure to mobile phones. *J Expo Sci Environ Epidemiol*, 19: 369–381. doi:10.1038/jes.2008.27 PMID:18493271
- Vrijheid M, Cardis E, Armstrong BK *et al.* Interphone Study Group (2006). Validation of short term recall of mobile phone use for the Interphone study. *Occup Environ Med*, 63: 237–243. doi:10.1136/oem.2004.019281 PMID:16556742
- Vrijheid M, Mann S, Vecchia P *et al.* (2009a). Determinants of mobile phone output power in a multinational study: implications for exposure assessment. *Occup Environ Med*, 66: 664–671. doi:10.1136/oem.2008.043380 PMID:19465409
- Wainwright P (2000). Thermal effects of radiation from cellular telephones. *Phys Med Biol*, 45: 2363–2372. doi:10.1088/0031-9155/45/8/321 PMID:10958200
- Wang J & Fujiwara O (2003). Comparison and evaluation of electromagnetic absorption characteristics in realistic human head models of adult and children for 900-MHz mobile telephones. *IEEE Trans Microw Theory Tech*, 51: 966–971. doi:10.1109/TMTT.2003.808681
- Wang J, Fujiwara O, Kodera S, Watanabe S (2006). FDTD calculation of whole-body average SAR in adult and child models for frequencies from 30 MHz to 3 GHz. *Phys Med Biol*, 51: 4119–4127. doi:10.1088/0031-9155/51/17/001 PMID:16912372
- Whiteside H & King RWP (1964). The loop antenna as a probe. *IEEE Trans Antenn Propag*, AP-12: 291–297. doi:10.1109/TAP.1964.1138213
- WHO (2010a). *Radio frequency (RF) fields - new 2010 research agenda*. Available at: http://whqlibdoc.who.int/publications/2010/9789241599948_eng.pdf.
- WHO (2010b). Fact Sheet N°193
- Wiat J, Dale C, Bosisio AD, Le Cornec A (2000). Analysis of the Influence of the Power Control and Discontinuous Transmission on RF Exposure with GSM Mobile Phones. *IEEE Trans Electromagn Compat*, 42: 376–385. doi:10.1109/15.902307
- Wiat J, Hadjem A, Gadi N *et al.* (2005). Modeling of RF head exposure in children. *Bioelectromagnetics*, 26: Suppl 7S19–S30. doi:10.1002/bem.20155 PMID:16142772
- Wiat J, Hadjem A, Gadi N *et al.* (2007). *RF Exposure assessment in children head: Present questions and future challenges*. International Conference on Electromagnetics in Advanced Applications (ICEAA), Sept. 17–21, Torino, pp. 1034–1035.
- Wiat J, Hadjem A, Wong MF, Bloch I (2008). Analysis of RF exposure in the head tissues of children and adults. *Phys Med Biol*, 53: 3681–3695. doi:10.1088/0031-9155/53/13/019 PMID:18562780
- Wickersheim K-A & Sun M-H (1987). Fiberoptic thermometry and its applications. *J Microw Power*, 22: 85–94.
- Willett JC, Bailey JC, Leteinturier C, Krider EP (1990). Lightning electromagnetic radiation field spectra in the interval from 0.2 to 20 MHz. *J Geophys Res*, 95: D1220367–20387. doi:10.1029/JD095iD12p20367
- World Bank; International Monetary Fund (2009). *Global Monitoring Report 2009: A Development Emergency*. Washington DC, USA. Available at: <https://openknowledge.worldbank.org/handle/10986/2625>
- Wu T, Tan L, Shao Q *et al.* (2011). Chinese adult anatomical models and the application in evaluation of RF exposures. *Phys Med Biol*, 56: 2075–2089. doi:10.1088/0031-9155/56/7/011 PMID:21386138

2. CANCER IN HUMANS

This section is a review of the large body of epidemiological evidence from studies of exposure of occupational groups and the general population to radiofrequency (RF) radiation from diverse sources, including from the use of mobile telephones. The results of these studies comprise a large amount of data, which could not be fully reproduced here. The Working Group included studies that assessed specific sources of RF radiation or job titles that were specifically linked to RF radiation. Studies that were excluded used job titles only for classification, or source surrogates only, without specifically addressing RF exposure. The Tables in this section summarize the main findings, but do not uniformly capture the results for all exposure metrics or all subgroups given in the original publications. In the text, the Working Group provides comments on those findings that are of greatest relevance to the evaluation, e.g. risk in the overall exposed group, patterns of change in risk with increasing exposure (such as a monotonic increase in risk with increasing exposure), and changes in risk with duration of exposure or latency.

2.1 Occupational exposure

The occupational environment is one domain in which humans are exposed to RF radiation. Many occupational circumstances entail regular or occasional exposure to RF radiation from fixed or mobile sources. A wide variety of workers are involved, including military and security personnel using walkie-talkie devices, radar operators, radio and television antenna maintenance and repair workers, welders performing dielectric (high-frequency) welding and sealing of plastics, workers using RF radiation for drying or testing operations, and physiotherapists employing medical diathermy equipment. Only a limited number of studies have assessed the risk of cancer in relation to either measured or inferred levels of exposure. There have been

a large number of epidemiological studies of workers who were not evaluated in terms of their exposure to RF radiation, but rather with respect to their exposure to electric or magnetic fields (EMF), extremely low-frequency (ELF) fields, i.e. $< 300\text{Hz}$ ([IARC, 2002](#)), or microwaves (MW), and an even larger number of studies in which it might be suspected that some workers were likely to have been exposed to RF radiation. The Working Group did not include these studies in the present review because it was not certain that sizable fractions of the workers in such studies were actually exposed to RF radiation, or at what levels they were exposed. This review is therefore limited to occupational studies in which the investigators made an effort to specifically document or assess exposures to RF radiation in the workers considered to be exposed.

2.1.1 Cancer of the brain

(a) Case-control studies

[Thomas et al. \(1987\)](#) conducted a death-certificate-based case-control study in selected counties of the north-eastern and southern United States of America (USA). The cases were men who had died from tumours of the brain or other parts of the central nervous system (CNS) at age ≥ 30 years between 1978 and 1981. Diagnoses were verified in hospital records. One control decedent, whose cause of death was not brain cancer, epilepsy, stroke, suicide or homicide, was selected for each case, and matched by age and year of death, and usual area of residence. The next-of-kin of the study subjects were interviewed: participation rates were 74% for cases and 63% for controls. For each job held since age 15 years, the job title and a brief description of the work, the industry, the location, the employment dates, and the hours worked per week were obtained. Two methods were used to classify men according to their occupational exposure to MW or RF radiation: one was based on a selection of broad job titles [most of which would have had mixed or predominant exposure to EMF frequencies other than RF], while in the other an industrial hygienist classified each job according to exposure to RF radiation, lead and soldering fumes. Data from 435 cases and 386 controls were analysed. Only results based on the industrial hygienist's classification are reviewed here. [While controls were individually matched to cases, there was a deficit of controls, possibly due to poorer participation, but no mention was made of adjusting for the matching variables in the analysis; thus there may have been uncorrected bias due to study design in the calculated odds ratios (ORs).] Risk of brain tumours was increased in those ever occupationally exposed to RF radiation (OR, 1.7; 95% CI, 1.1–2.7) adjusted for educational level ([Table 2.1](#)); however, the odds ratio decreased when men also exposed to soldering fumes or lead were removed from

the exposed group, and dropped even further when those who might also have had exposure to organic solvents were removed from the exposed group. [This study was one of the few to directly attempt to address possible confounding of occupational exposure to RF radiation with coexposure to soldering fumes, lead and organic solvents. It was limited by the fact that it was based on death certificates (the dead controls were unlikely to accurately represent the population from which the dead cases came) and on an analysis that may not have controlled for bias due to the matched design.]

[Berg et al. \(2006\)](#) analysed data obtained from cases (glioma and meningioma) and controls using a detailed questionnaire on occupational exposure to what the authors described as RF/MW/EMF, which formed part of the data collected in the German component of the INTERPHONE study (as described in Section 2.2.2 in relation to [Schüz et al., 2006a](#)). Participants were asked screening questions about use of industrial heating equipment to process food, to bond, seal, and weld materials, or to melt, dry, and cure materials. Questions were also asked about manufacturing semiconductor chips or microelectronic devices; using radar; maintaining electromagnetic devices used to treat or diagnose diseases; working with or nearby to broadcasting and telecommunications antennae and masts; using different kinds of transmitters; and using amateur (“ham”) radio. When a participant screened positive for one of these activities, further questions were asked to determine whether the occupation entailed exposure to RF/MW/EMF. Each person was classified as having: no exposure (responded negatively to the screening questions, or were positive for some activities thought not to entail exposure); no probable exposure (exposure existed but probably not exposed continuously during working hours in any activity); probable exposure (probably exposed continuously during working hours in at least one activity); or high exposure

Table 2.1 Case-control studies on cancer of the brain and occupational exposure to radiofrequency radiation

Reference, study location and period	Total cases	Total controls	Control source (hospital, population)	Exposure assessment	Organ site (ICD code)	Exposure categories	Exposed cases	Relative risk (95% CI)	Comments
Thomas et al. (1987) USA, 1979–81	435	386	Death certificates of residents who had died from a cause other than brain tumour, epilepsy, stroke, suicide or homicide, matched to cases by age and year at death, and area of residence	Next-of-kin interviews regarding employment history and other risk factors for brain tumours. Exposure classified according to job title and results of previous studies, and by an industrial hygienist	Brain	<i>Occupational exposure to MW or RF based on assessment by the industrial hygienist</i>			Restricted to white men aged > 30 yr. Methods of statistical analysis were not described. Covariates: matched by age and year at death, and area of residence, but not included as covariates in the unmatched analysis
						Never exposed		1.0	
						Ever exposed		1.7 (1.1–2.7)	
						Ever exposed, excluding those with co-exposure to soldering fumes or lead		1.4 (0.7–3.1)	
						Ever exposed, excluding those with co-exposure to organic solvents	2	0.4 (NR)	

Table 2.1 (continued)

Reference, study location and period	Total cases	Total controls	Control source (hospital, population)	Exposure assessment	Organ site (ICD code)	Exposure categories	Exposed cases	Relative risk (95% CI)	Comments
Berg et al. (2006) Germany, 2000–03	381 cases of meningioma, 366 cases of glioma	1494, of whom 732 matched to glioma and 762 to meningioma cases	2449 controls frequency-matched on age, sex and centre, were derived from population registries, 63% participated. Subsequently, controls were matched to cases on a 2:1 basis	CAPI mostly in hospital for cases, and at home for controls. Interview included questions about job title and specific occupational activities followed by expert assessment of exposure to RF/MW	Glioma (C71.0–71.9; 9380–9383, 9390–9393, 9400–9401, 9410–9411, 9420–9421, 9440–9442, 9450–9451) and meningioma (C70.0; 9530–9539)	<i>Exposure to RF</i>			Aged 30–69 yr Covariates: SES, urban or rural, exposure to ionizing radiation, smoking history, age at diagnosis
						<i>Glioma</i>			
						Total exposure:			
						No/not probable	328	1.00	
						Probable/high exposure	38	1.04 (0.68–1.61)	
						Probable exposure:			
						No exposure	308	1.00	
						Not probable	20	0.84 (0.48–1.46)	
						Probable	16	0.84 (1.46–1.56)	
						High	22	1.22 (0.69–2.15)	
Duration of high exposure:									
Not highly exposed	344	1.00							
Highly exposed for < 10 yr	9	1.11 (0.48–2.56)							
Highly exposed for ≥ 10 yr	13	1.39 (0.67–2.88)							

Table 2.1 (continued)

Reference, study location and period	Total cases	Total controls	Control source (hospital, population)	Exposure assessment	Organ site (ICD code)	Exposure categories	Exposed cases	Relative risk (95% CI)	Comments
Berg et al. (2006) (contd.)						<i>Meningioma</i>			
						Total exposure:			
						No/not probable	355	1.00	
						Probable/high exposure	26	1.12 (0.66–1.87)	
						Probable exposure:			
						No exposure	340	1.00	
						Not probable	15	1.11 (0.57–2.15)	
						Probable	15	1.01 (0.52–1.93)	
						High	11	1.34 (0.61–2.96)	
						Duration of high exposure:			
						Not highly exposed	370	1.00	
						Highly exposed for < 10 yr	5	1.14 (0.37–3.48)	
						Highly exposed for ≥ 10 yr	6	1.55 (0.52–4.62)	

Table 2.1 (continued)

Reference, study location and period	Total cases	Total controls	Control source (hospital, population)	Exposure assessment	Organ site (ICD code)	Exposure categories	Exposed cases	Relative risk (95% CI)	Comments	
Karipidis et al. (2007) Australia, 1987–91	416	422	Population of four major centres as recorded by the electoral rolls for the Australian state of Victoria	Comprehensive job history, including self-reported RF exposure in each job, expert assessment by occupational hygienist and application of a community-based job-exposure matrix, FINJEM	Glioma (ICD-O codes 938–946)	<i>Total cumulative exposure to RF given by FINJEM (W/m².yr)</i>				Covariates: age, sex, and year of education
						Unexposed	396	1.00		
						> 0–11	4	0.57 (0.16–1.96)		
						> 11–52	8	1.80 (0.53–6.13)		
						> 52	6	0.89 (0.28–2.81)		
						<i>P</i> trend		0.91		
						<i>Self-reported duration of exposure (yr) to RF</i>				
						Unexposed	385	1.00		
						> 0–3	9	0.53 (0.23–1.21)		
						> 3–8	8	0.43 (0.18–1.00)		
						> 8	12	0.82 (0.37–1.82)		
						<i>P</i> trend		0.08		
						<i>Expert assessment of duration of exposure (yr) to RF</i>				
						Unexposed	381	1.00		
						> 0–3	10	1.20 (0.48–3.04)		
> 3–6	12	1.65 (0.66–4.17)								
> 6	11	1.57 (0.62–4.02)								
<i>P</i> trend		0.17								

Table 2.1 (continued)

Reference, study location and period	Total cases	Total controls	Control source (hospital, population)	Exposure assessment	Organ site (ICD code)	Exposure categories	Exposed cases	Relative risk (95% CI)	Comments	
Baldi et al. (2011) France, 1999–2001	221	442	Population selected from local electoral rolls and individually matched on age, sex and department of residence	Interviewer-administered face-to-face questionnaire, which included a lifetime occupational history documenting for each job held for ≥ 6 mo: job title, industry, begin and end dates, and details of tasks performed. Occupational hygienists assessed probability of exposure to RF and duration for each job.	CNS (70.0–70.9, 71.0–71.9, 72.2–72.9)	<i>Occupational exposure to RF</i>				95 males, 126 females. 70% of eligible cases participated and 69% of eligible and contactable controls. Covariates: exposure to pesticides, smoking, educational level
						All brain tumours (<i>n</i> = 221):				
						Unexposed	148	1.00		
						Exposed	7	1.50 (0.48–4.70)		
						Glioma (<i>n</i> = 105):				
						Unexposed	71	1.00		
						Exposed	7	1.44 (0.50–4.13)		
						Meningioma (<i>n</i> = 67):				
						Unexposed	61	1.00		
						Exposed	0	-		
Acoustic neurinoma (<i>n</i> = 32):										
Unexposed	31	1.00								
Exposed	1	0.40 (0.05–3.42)								
<i>Amateur radio practice</i>										
All brain tumours (<i>n</i> = 221):										
No	NR	1.00								
Yes	NR	1.39 (0.67–2.86)								

CAP, computer-assisted personal interview; FINJEM, FIN(nish) job-exposure matrix; mo, month; MW, microwave; NR, not reported; RF, radiofrequency radiation; SES, socioeconomic status; W, watt; yr, year

(certainly exposed continuously during working hours and sometimes at levels $> 0.08\text{W/kg}$ in at least one activity). Analyses included data from proxy interviews, and results were not sensitive to removal of proxy interview data. There was weak evidence that risk of glioma and of meningioma increased with increasing duration of high occupational exposure to RF/MW/EMF. For glioma, the odds ratio for < 10 years of high exposure relative to no exposure was 1.11 (95% CI, 0.48–2.56) and that for ≥ 10 years of high exposure was 1.39 (95% CI, 0.67–2.88); the analysis controlled for centre, sex, age at diagnosis, socioeconomic status, urban or rural area, exposure to ionizing radiation, and smoking history. The corresponding odds ratios for meningioma were 1.14 (95% CI, 0.37–3.48) and 1.55 (95% CI, 0.52–4.62) (Table 2.1). [The strengths of this study were its large size and evaluation of exposure at the job-activity level. Its main weaknesses included the small numbers of cases with high exposure and lack of associated consideration of other sources of exposure to RF radiation.]

Karipidis *et al.* (2007) reported on risk of glioma in relation to occupational exposure to RF radiation in a case–control study in five major population centres in the Australian state of Victoria. Cases were patients aged 20–70 years with glioma, newly diagnosed between July 1987 and December 1991, who were ascertained by screening the medical records of 14 major Melbourne (capital of Victoria) hospitals that together provided most of the neurosurgical services in the state. Completeness of ascertainment was checked against cancer-registry records of Victoria. Controls were randomly selected from the electoral rolls and frequency-matched to cases by age and sex; the electoral rolls covered about 85% of citizens at that time. Controls were excluded if they had a history of brain tumour, stroke or epilepsy. Participants completed a self-administered work-history questionnaire, which included queries about occupation, employer, industry, main tasks and duties, equipment used,

start and finish dates, number of hours worked per day, number of days worked per week and whether or not they had been exposed to RF radiation, for all jobs undertaken since age 12 years that had lasted ≥ 3 months. Work histories were checked for completeness at a subsequent face-to-face interview. For 44% of cases and 2% of controls, a next-of-kin proxy completed the work history. In addition to the self-report, exposure to RF radiation was assessed from the work history by use of the Finnish National Job-Exposure Matrix (FINJEM; a community-based job-exposure matrix developed by the Finnish Institute of Occupational Health) and by review of the work histories by an expert occupational hygienist. Four categories of cumulative exposure were created for each exposure measure: unexposed, and thirds of the ranked exposure distributions for all exposed subjects. Results were adjusted for age, sex and years of schooling (a surrogate for socioeconomic status). Data on occupational exposure were obtained for 414 cases and 421 controls, i.e. 66% and 65%, respectively, of those eligible and contactable [respective numbers not contacted were not given]. With FINJEM, 18 cases and 17 controls were classified as exposed to RF radiation, 29 and 48 by self-report and 33 and 25 by expert assessment. Only in the case of classification based on expert assessment of exposure was there any consistent indication that risk of glioma increased with exposure to RF radiation: relative to those who were not exposed, odds ratios were 1.20 (95% CI, 0.48–3.04) for > 0 –3 years of exposure, 1.65 (95% CI, 0.66–4.17) for > 3 –6 years and 1.57 (95% CI, 0.62–4.02) for > 6 years (Table 2.1). Analyses excluding participants with proxy information showed no major differences in results. [The use of multiple measures of occupational exposure to RF radiation, including expert assessment of a comprehensive occupational history, was a strength of the study. It was limited by lack of inclusion of non-contactable subjects when estimating participation rates, by the large proportion of

cases requiring proxy respondents and by the comparatively small number of subjects who were exposed to RF radiation. FINJEM provides a probably incomplete assessment of occupational exposure to RF radiation.]

[Baldi et al. \(2011\)](#) reported on a case-control study of people aged ≥ 16 years, newly diagnosed with cancer of the primary CNS between mid-1999 and mid-2001 in the administrative region of Gironde in south-western France. Patients with neurofibromatosis, Von Hippel-Lindau disease or AIDS were excluded. Controls were selected from local electoral rolls, which automatically register all French subjects, and individually matched to cases by age, sex and department of residence. Participation rates were 70% of eligible cases and 69% of eligible and contactable controls. Occupational exposure to RF radiation was assessed by two occupational hygienists from lifetime histories of jobs that had lasted ≥ 6 months (including job title, industry, dates each job began and ended, details of tasks performed), which were collected by face-to-face interview. Information on use of amateur radio was also collected. The odds ratio for occupational exposure to RF radiation and all tumours of the brain was 1.50 (95% CI, 0.48–4.70), while for use of amateur radio it was 1.39 (95% CI, 0.67–2.86) ([Table 2.1](#)). [The Working Group noted the comparatively small size of the study and the small number of exposed subjects, which appeared to have precluded analysis at multiple exposure levels; the exposure assessment based on a comparatively limited occupational history, and an estimated participation rate for controls that was not based on all potentially eligible participants.]

(b) Cohort studies

[Lilienfeld et al. \(1978\)](#) reported on a retrospective cohort study of USA employees and their dependents who had worked or lived at the United States embassy in Moscow during 1953–1976 and, for comparison, employees and their

dependents at other United States embassies in eastern Europe who had not served in Moscow over the same period. There were unusual levels of background exposure to MW in the embassy in Moscow. The maximum measured levels were $5 \mu\text{W}/\text{cm}^2$ for 9 hours per day, $15 \mu\text{W}/\text{cm}^2$ for 18 hours per day, and $< 1 \mu\text{W}/\text{cm}^2$ thereafter for non-overlapping time periods between 1953 and 1975 and between 1975 and 1976. Only background levels of exposure to MW were recorded in other eastern-European embassies. Relevant health information and follow-up data were obtained from the medical records of employees and their dependents (held by the Department of State) and a health-history questionnaire sent to each employee or dependent who could be located. Death certificates were sought for all decedents. The analysis was based only on subjects who could be traced ($> 90\%$): 1719 Moscow employees and 1224 dependents known to have lived with them in the embassy, and 2460 employees at other embassies and 2072 dependents known to have lived with them. For embassy employees, 194 deaths were ascertained; of these, there was sufficient information for 181 for inclusion in the analysis, and death certificates were available for 125. There were no deaths from tumours of the brain or other parts of the CNS in Moscow employees, compared with 0.9 expected on the basis of comparable mortality rates in the USA [standardized mortality ratio, SMR, 0; 95% CI, 0–4.1]. For other embassy employees, there were five deaths from tumours of the brain or other parts of the CNS, with 1.5 expected (SMR, 3.3; 95% CI, 1.1–7.7). For dependents known to have lived in the relevant embassy, $> 90\%$ were traced, 67 deaths were ascertained, 62 death certificates were available. There were no observed deaths from tumours of the brain or other parts of the CNS (0.15 expected) [SMR, 0; 95% CI, 0–24.6] for the Moscow embassy and 1 death was observed (0.19 expected) for the other embassies ([Table 2.2](#)). [This study was available only in a United States government report; it was not published in the

peer-reviewed literature. Its main weaknesses were the small sizes of the two cohorts and the small number of deaths from cancer of the CNS observed. The long and continuous exposure to high background levels of MW in the Moscow Embassy was a strength. Possible confounding factors were not addressed.]

[Milham \(1988a, b\)](#) followed a cohort of people who were licensed as amateur radio-operators between 1 January 1979 and 16 June 1984 (a licence was valid for 5 years) and had addresses in Washington State or California. The full names and dates of birth of male cohort members (67 829 people; there were few females) were matched with deaths in Washington State and California. Only exact matches were accepted. Person-years at risk started on the effective current registration day and ended on the day of death, or on 31 December 1984. There were 232 499 person-years at risk and 2485 deaths; 29 deaths from cancer of the brain (International Classification of Disease Revision 8 [ICD-8] code 191) were observed and 20.8 expected [the death rates used to estimate the expected numbers were not specified], SMR for deaths from cancer of the brain was 1.39 (95% CI, 0.93–2.00) ([Table 2.2](#)). Licensees were further subdivided by licence class, i.e. Novice, Technician, General, Advanced and Extra. Novices were limited in their use of transmitter power and transmission frequencies; these conditions became more liberal as licence class rose. The average age increased with rising licence class; those holding higher-level licences may have generally been amateur radio operators for longer than those holding lower-level licences. Deaths from cancer of the brain were more frequent than expected for each licence class after Novice, but with little evidence of progressive increases as licence class rose ([Table 2.2](#)). [The main strength of this study was its clear and straightforward execution. Its weaknesses included lack of information about erroneous or missed links of cohort members to deaths, lack of consideration of possible migration of cohort

members from Washington State and California, limited validation of licence class as a surrogate for intensity and duration of exposure to RF radiation, and the small number of observed deaths from cancer of the brain. Possible confounding factors were not addressed.]

[Armstrong *et al.* \(1994\)](#) carried out a nested case-control analysis of the association of several cancers, including tumours of the brain, and exposure to pulsed electromagnetic fields (PEMFs; frequency range, 5–20 MHz) in two cohorts of electrical-utility workers in Quebec, Canada (21 749 men; follow-up, 1970–1988), and France (170 000 men; follow-up, 1978–1989), among whom 2679 cases of cancer were identified, 84 malignant tumours of the brain and 25 benign tumours of the brain. Utility-based job-exposure matrices were created with information obtained from surveys of samples of 466 (Quebec) and 829 (France) workers wearing exposure meters in 1991–1992. For malignant tumours, the odds ratios were 0.84 (95% CI, 0.47–1.50) for above-median exposure to PEMFs and 1.90 (95% CI, 0.48–7.58) for exposure at or above the 90th percentile, while for astrocytoma – the most common type of glioma – the odds ratio for exposure at or above the 90th percentile was 6.26 (95% CI, 0.30–132). For benign tumours, the odds ratio was 1.58 (95% CI, 0.52–4.78) for above-median exposure. None of the odds ratios for other subtypes of cancer of the brain were elevated ([Table 2.2](#)).

[Grayson \(1996\)](#) reported on risk of brain cancer related to exposure to equipment producing RF or MW (RF/MW) radiation in a case-control study conducted within a cohort of male members of the United States Air Force in 1970–89 ([Table 2.2](#)). Four matched controls were randomly selected for each case from all cohort members. Controls were not eligible if they had been diagnosed with leukaemia, cancer of the breast or melanoma “...because excess risks of these tumours have been associated with EMF exposures in other studies” [this exclusion was

not appropriate in a nested case-control study as if the excluded tumours were associated with EMF exposure, this could bias exposure in controls downwards, though probably only to a very small degree given the relative rarity of these cancers]. An expert panel assessed each job title-time couplet for probability of exposure to RF/MW radiation, which was recorded as “unexposed,” “possibly exposed” and “probably exposed.” Incident cases of cancer of the brain (ICD-9 code 191) were identified from hospital discharge records of serving personnel; confirmatory data (imaging or histopathology records) were not sought. Conditional logistic regression was used for the analysis; no potential confounders were included as covariates in the models. The odds ratio for cancer of the brain with ever-exposure to RF/MW was 1.39 (95% CI, 1.01–1.90). There was only weak evidence of a trend towards increasing odds ratio with increase in the value of the product of a score for probable intensity of exposure and duration of exposure. [The strengths of this study included its basis within a cohort, the careful design and the probably complete ascertainment of brain cancers occurring within the study period. It is limited by its lack of confirmation of diagnosis through access to diagnostic records, the reliance on occupational title to identify instances of potential exposure to RF/EMF radiation, and the uncertain accuracy of exposure quantification. Any bias due to these weaknesses would probably be towards the null and would weaken a dose-response relationship, if there were one.]

[Szmigielski \(1996\)](#) studied the incidence of cancer in the whole population of career military personnel in Poland from 1971 to 1985, averaging about 127 800 men over these 15 years. [This study appeared to be a cross-sectional study rather than a cohort study ([Table 2.2](#)).] Annual data were obtained on all career servicemen from personnel and health departments, and included numbers of servicemen, types of service posts and exposure to possible

carcinogenic factors during service, while military safety groups provided information on the number of personnel exposed to RF radiation. On average, 3720 men were considered to have been exposed to RF radiation each year. It was estimated that of these, 80–85% were exposed at $< 2 \text{ W/m}^2$ and the remainder at $2\text{--}6 \text{ W/m}^2$, but individual exposure levels could not be assigned. Exposure was largely to pulse-modulated RF radiation at 150–3500 MHz. Annual data on all men newly diagnosed with cancer were collected from records of military hospitals and the military medical board; in addition to type of cancer, they included duration and type of service and exposure to possible carcinogenic factors during service, including whether or not they were exposed to RF radiation. [It was unclear from the text whether information in individual health records may have been used, in addition to information applicable to all servicemen, in allocating a man diagnosed with cancer to the group exposed to RF radiation.]

[It appeared to the Working Group that these data were insufficient to permit calculation of annual age-specific rates of all cancers (in age groups of 10 years) and individual types of cancer in men exposed to RF radiation and men not exposed and thus to calculate ratios of incidence in the exposed group to that in the unexposed group for each year and for the whole period. The methods were described in limited detail and it was not stated how the rates or rate ratios were summarized across age groups and years and, in particular, whether cancer-incidence rate ratios based on all exposed and all unexposed men were age-standardized. The observed numbers of cases of all cancers or individual types of cancer were not presented, but could be approximated from average annual rates of incidence, from which it appeared that two to three cases of cancer of the nervous system and brain (ICD codes not specified) were diagnosed in men exposed to RF radiation over the 15 years, and about 54 cases in men not exposed.]

Table 2.2 Cohort studies of cancer of the brain and occupational exposure to radiofrequency radiation

Reference, study location	Total No. of subjects	Follow-up period	Exposure assessment	Organ site (ICD code)	Exposure categories	No. of cases/deaths	Relative risk (95% CI)	Covariates	Comments
Lilienfeld et al. (1978) United States embassies in eastern Europe	7475	1953–76	Worked or lived in the United States embassy in Moscow during study period. The maximum measured levels were 5 $\mu\text{W}/\text{cm}^2$ for 9 h/d, 15 $\mu\text{W}/\text{cm}^2$ for 18 h/d, and < 1 $\mu\text{W}/\text{cm}^2$ thereafter for non-overlapping periods between 1953 and 1975 and between 1975 and 1976	Brain and CNS (ICD-7 code 193)	<i>Role and location in eastern Europe</i>		SMR	Sex, age	SMRs are relative to the corresponding mortality rates in the USA. Contract report is available through the National Technical Information Service of the USA.
					Employed in the United States embassy in Moscow	0	0 [0–4.1]*		
					Dependent of a Moscow United States embassy employee	0	0 [0–24.6]*		
					Employed in a different United States embassy in eastern Europe	5	3.3 [1.1–7.7]*		
					Dependent of an employee at a different United States embassy in eastern Europe	1	5.3 [0.13–29]*		
Milham (1988a, b) USA	67 829	1979–84	Licensing as an amateur radio operator	Brain (191)	<i>Amateur radio operator licence class</i>		SMR		
					Novice	1	0.34		
					Technician	4	1.12		
					General	11	1.75		
					Advanced	11	1.74		
					Extra	2	1.14		
					All	29	1.39 (0.93–2.00)		

Table 2.2 (continued)

Reference, study location	Total No. of subjects	Follow-up period	Exposure assessment	Organ site (ICD code)	Exposure categories	No. of cases/deaths	Relative risk (95% CI)	Covariates	Comments		
Armstrong et al. (1994) Canada and France	191 749	1970–89	Exposure assessed through a job-exposure matrix based on about 1000 person-weeks of measurements from exposure meters worn by workers to derive estimates of short-duration PEMFs, or high-frequency transient fields.	Brain (191)	PEMFs			OR	SES	Nested case-control analysis. Controls for each case were selected at random from the cases risk set and matched by utility and year of birth. Exposure was counted only up to the date of diagnosis of the case.	
					Malignant cancer of the brain:						
					< Median	49	1.00				
					> Median	35	0.84 (0.47–1.50)				
					≥ 90th percentile	9	1.90 (0.48–7.58)				
					Astrocytoma:						
					< Median	22	1.00				
					> Median	12	0.89 (0.29–2.67)				
					≥ 90th percentile	3	6.26 (0.30–132)				
					Glioblastoma:						
					< Median	16	1.00				
					> Median	13	0.49 (0.19–1.28)				
					≥ 90th percentile	5	0.57 (0.08–3.91)				
					Other cancers:						
< Median	7	1.00									
> Median	6	2.67 (0.43–16.71)									
≥ 90th percentile	1	-									
Benign tumours of the brain:											
< Median	9	1.00									
> Median	16	1.58 (0.52–4.78)									
≥ 90th percentile	1	-									

Table 2.2 (continued)

Reference, study location	Total No. of subjects	Follow-up period	Exposure assessment	Organ site (ICD code)	Exposure categories	No. of cases/deaths	Relative risk (95% CI)	Covariates	Comments
Grayson (1996) USA	230 cases, 920 controls	1970–89	Job title-time-exposure matrix. Census of control histories was carried out at time of matched case's diagnosis. Exposure score was the sum of the products of duration of deployment in each job and the assessed probability of RF exposure in that job at that time.	Brain (191)	<i>RF/MW</i>		OR	Controls exactly matched to case on year of birth, race and presence in the cohort at the time when the case was diagnosed. Matching retained in analysis. Age, race, rank (senior or other) included as covariates.	United States Air Force personnel Nested case-control analysis within cohort study. All male members of United States Air Force. Rank associated with risk; senior officers at increased risk.
					Never exposed	94	1.00		
					Exposed	136	1.39 (1.01–1.90)		
					<i>RF/MW exposure score</i>				
					None	136	1.00		
					2–48	15	1.26 (0.71–2.24)		
					49–127	29	1.50 (0.90–2.52)		
128–235	25	1.26 (0.71–2.22)							
236–610	25	1.51 (0.90–2.51)							
Szmigielski (1996) Poland	Average of 127 800 men, yearly during 15 yr	1971–85	Military safety (health and hygiene) groups classified military service posts as having exposure, or not, to RF	Nervous system, including brain	<i>Occupational exposure to RF</i>		None specified	Cross-sectional study. Incidence rate ratio for all cancers, 2.07 (95% CI, 1.12–3.58) suggests possible upward bias in rate ratios.	
					Not exposed	[54]*			1.00
					Exposed	[2–3]*			1.91 (1.08–3.47)
					<i>P</i> value	< 0.05			
Tynes et al. (1996) Norway	2619 women	1961–91	Radio and telegraph operators with potential exposure to RF and ELF	Brain (ICD-7 code 193)	Radio and telegraph operators with potential exposure to RF and ELF	5	SIR, 1.0 (0.3–2.3)	Age, time since certification, calendar year, age at first childbirth	Women certified as radio and telegraph operators 1920–80

Table 2.2 (continued)

Reference, study location	Total No. of subjects	Follow-up period	Exposure assessment	Organ site (ICD code)	Exposure categories	No. of cases/deaths	Relative risk (95% CI)	Covariates	Comments
Lagorio et al. (1997) Italy	481 women	1962–92	Occupational history from plant records. RF generated by dielectric heat sealers. Exposure of 10 W/m ² equivalent power-density frequently exceeded.	Brain (191)	<i>Job title</i>			Sex, age, calendar period-specific regional person-year at risk	Mortality analysis restricted to women
					RF-sealer operators	1	10 [0.25–56]*		
					Other workers	0	0 [0–46]*		
					All female workers	1	5 [0.13–28]*		
Morgan et al. (2000) USA	195 775 Motorola employees	1976–96	Job-exposure matrix	Brain/CNS	<i>Cumulative exposure to RF</i>		<i>Rate ratio</i>	Age, sex, and race for external comparisons; and age, sex, and period of hire for internal comparisons	All employees of Motorola; exposure from cellular phones not assessed. Definition of exposure categories unclear.
					None	34	1.00		
					< Median	7	0.97 (0.37–2.16)		
					≥ Median	10	0.91 (0.41–1.86)		
					<i>Usual exposure to RF</i>				
					None	38	1.00		
					Low	7	0.92 (0.43–1.77)		
					Moderate	3	1.18 (0.36–2.92)		
					High	3	1.07 (0.32–2.66)		
					<i>Peak exposure to RF</i>				
					None	34	1.00		
					Low	10	0.98 (0.50–1.80)		
					Moderate	3	0.70 (0.21–1.77)		
					High	4	1.04 (0.36–2.40)		
					<i>Duration of exposure</i>				
					None	44	1.00		
≤ 5 yr	3	0.74 (0.22–1.84)							
> 5 yr	4	0.99 (0.35–2.26)							
<i>Cumulative exposure to RF</i>									
Males-low	23	1.00							
Males-high	8	1.11 (0.38–2.78)							
Females-low	18	1.00							
Females-high	2	0.58 (0.03–3.30)							

Table 2.2 (continued)

Reference, study location	Total No. of subjects	Follow-up period	Exposure assessment	Organ site (ICD code)	Exposure categories	No. of cases/deaths	Relative risk (95% CI)	Covariates	Comments
Groves et al. (2002) USA	40 581 men (271 women excluded)	1950–97	United States Navy personnel with potential for RF exposure; job classified as entailing low or high exposure	Brain (ICD-9 codes 191.0–191.9)	<i>Job-associated exposure to RF</i>		SMR	Age at cohort entry, attained age	White United States Navy (male) veterans of Korean War (1950–54)
					Low	51	1.01 (0.77–1.33)		
					High	37	0.71 (0.51–0.98)		
					Total cohort	88	0.86 (0.70–1.06)		
					Within-cohort comparison:				
					Low exposure	51	1.00		
High exposure	37	0.65 (0.43–1.01)							
Degraeve et al. (2009) Belgium	Military personnel (4417 men) in battalions equipped with radar, and 2932 controls	1968–2003	Exposure levels on the site where the battalion lived and worked were characterized, individual exposure assessment could not be conducted.	Cancer of eye, brain and nervous system (190–192)	Control cohort	2	1.00		Cause of death found for 71% of the men in the radar group and 70% in the control group.
					Radar-exposed	8	2.71 (0.42–17.49)		

* values calculated/deduced by the Working Group

d, day or days; ELF, extremely low-frequency electric and magnetic field; h, hour or hours; mo, month; MW, microwaves; OR, odds ratio; PEMFs, pulsed electromagnetic fields; RF, radiofrequency radiation; SES, socioeconomic status; SIR, standardized incidence ratio; SMR, standardized mortality ratio; W, watt; yr, year

The incidence rate ratio (IRR) for cancer of the nervous system and brain over the 15 years in those exposed to RF radiation was estimated to be 1.91 (95% CI, 1.08–3.47). The corresponding incidence rate ratio for all cancers was 2.07 (95% CI, 1.12–3.58). [The similarity of these two incidence rate ratios suggested the possibility of consistent upward bias in their estimation. It also appeared that the 95% confidence intervals had not been correctly calculated given their similar width and the large difference in the observed numbers on which they were based: 2–3 cancers of the nervous system and brain and about 32 cancers of all types.] Age-specific incidence rate ratios for all cancers ranged from 2.33 at age 20–29 years to 1.47 at age 50–59 years. [This was somewhat against the hypothesis that failure to standardize by age had increased the incidence rate ratios with exposure to RF radiation. The interpretation of this study was hampered by its cross-sectional design, in which risk of cancer was related only to current exposure to RF radiation; uncertainty about the accuracy of the classification of exposure; lack of a quantitative measure of exposure; lack of information on completeness of ascertainment of cancer incidence; lack of clarity concerning the analytical methods, including whether incidence rate ratios were age-standardized; and probable errors in the statistical analysis. Possible confounding factors were not addressed. The possibility that medical records accessed for men with cancer may have provided information that led them to being classified as exposed to RF radiation may explain the apparently high risks of cancer in men exposed to RF radiation in this study.]

[Tynes *et al.* \(1996\)](#) examined incidence of cancer in a cohort of 2619 Norwegian women who were certified as radio and telegraph operators between 1920 and 1980 ([Table 2.2](#)); 98% had worked on merchant navy ships. They were followed from 1961 to 1991 via the Norwegian cancer registry; 41 were lost to follow-up. Electric and magnetic fields were measured in the radio

rooms of three older Norwegian ships. They were below detection levels at radio-frequencies at the operators' desks and were considered to be comparable to those found at normal Norwegian workplaces. The age- and calendar period-adjusted standardized incidence ratio (SIR) for cancers of the brain and nervous system (ICD-7 code 193) was 1.0 (95% CI, 0.3–2.3; based on five cases) with reference to the national Norwegian female population. [The strengths of this study were its homogeneous cohort and near-complete follow-up; its principal weaknesses were the small number of cases of brain cancer and the probably low exposure of the cohort to RF radiation. Possible confounding factors were not addressed.]

[Lagorio *et al.* \(1997\)](#) reported on mortality from all causes and from specific cancers in a group of 201 men and 481 women employed in a plastic-ware manufacturing facility in Grosseto, Italy, from 1962 to 1992 and followed until death, or until the end of 1992 ([Table 2.2](#)) Those lost to follow-up were considered to be alive at the end of 1992. Vital status and cause of death were ascertained from the registry office of the municipality of residence and death. Workers were classified into three groups: RF-sealer operators, other labourers and white-collar workers. RF-sealer operators received the greatest exposure to RF radiation. They were also exposed to vinyl chloride monomer due to its volatilization from polyvinyl chloride (PVC) sheets during sealing. At the end of follow-up, 661 subjects were alive, 16 had died and 5 were lost to follow-up [details of tracing methods were not given]. The mortality analysis was restricted to women, who were mostly employed in the manufacturing department (6772 person-years in RF-sealer operators). There was one death ascribed to a tumour of the brain and 0.2 expected based on mortality rates in the regional population; this single death occurred in an RF-sealer operator (expected, 0.1). [The principal weakness of this study was its

small size. Possible confounding from exposure to vinyl chloride was not addressed.]

[Morgan et al. \(2000\)](#) studied a cohort of all employees of Motorola USA with at least 6 months of cumulative employment, who were employed for at least 1 day between 1976 and 1996, and followed to 31 December 1996. Deaths were ascertained through reference to the Social Security Administration Master Mortality File and the National Death Index. Death certificates were obtained from the state vital statistics offices and company benefits records, and causes of death were coded according to ICD-9. There were 195 775 workers, 2.7 million person-years of follow-up and 6296 deaths, 53 of which were attributed to cancer of the CNS [ICD-9 codes not stated]. No losses to follow-up were reported [it is probable that the 116 700 workers who had retired or whose employment had been terminated were assumed to be alive if no death record was found for them]. Exposure to RF radiation was assessed on the basis of a company-wide job-exposure matrix, developed through expert consultation, that categorized each of 9724 job titles into one of four exposure groups: background, low, moderate, and high, corresponding roughly to < 0.6 W, $0.6- < 2.0$ W, $2.0- < 5.0$ W, $5.0- < 50$ W and ≥ 50 W. About 45 500 employees were thought to have had usual exposures of ≥ 0.6 W, 8900 employees had a high usual exposure (≥ 50 W) and 9000 employees had unknown usual exposure. Relative to mortality in the combined populations of Arizona, Florida, Illinois, and Texas, where most Motorola facilities were located, the SMR for tumours of the CNS was 0.60 (95% CI, 0.45–0.78). Internal comparisons between categories of estimated cumulative, usual and peak exposure to RF radiation; duration of exposure; (cumulative exposure lagged 5, 10 and 20 years) and cumulative exposure in males and females separately, showed no consistent evidence of an increase in risk of tumours of the CNS with increasing estimated exposure to RF radiation ([Table 2.2](#)). [The main

strength of this study was the clear and straightforward execution and comprehensive analyses. Its weaknesses included lack of measured exposure to RF radiation on which to base the exposure classification; inadequate description of the exposure-validation study; lack of detail on how the links between cohort members and death records were established, and therefore uncertainty about completeness and accuracy of death ascertainment; the comparatively small number of observed deaths from tumours of the CNS; and possible conservative bias due to exclusion of mobile-phone use from the estimate of exposure to RF radiation. Possible confounding factors were not addressed.]

[Groves et al. \(2002\)](#) reported on an extended follow-up to death or to the end of 1997 for 40 890 United States Navy personnel originally studied by [Robinette et al. \(1980\)](#). These men were graduates of Class-A Navy technical training schools who had served on ships in the Korean War during 1950–54, and who had potentially been exposed to high-intensity radar. They were divided into two occupational groups considered by a consensus of Navy personnel involved in training and operations to have had high exposure to RF radiation (electronics, fire-control and aviation-electronics technicians: 20 109 men) or low exposure (radiomen, radar men and aviation electricians' mates: 20 781 men). Potential exposure in each job category was evaluated from the records for 435 men who had died and those of a randomly selected 5% of living men as “the sum of all power ratings of all fire control radars aboard the ship or search radars aboard the aircraft to which the technician was assigned multiplied by the number of months of assignment.” Ascertainment of death required use of Department of Veterans' Affairs and Social Security Administration records and the National Death Index. [Its completeness was uncertain.] It was necessary to impute moderate proportions of dates of entry into the cohort (1950–54) and dates of birth, because of missing

data. The analysis was limited to 40 581 men and SMRs were calculated with reference to all white men in the USA, standardized for age at entry to the cohort and attained age. Altogether, there were 51 deaths from cancer of the brain (ICD-9 codes 191.0–191.9); there was no evidence of any increase in risk of cancer of the brain associated with high exposure to RF radiation ([Table 2.2](#)). The SMRs for cancer of the brain were 0.86 (95% CI, 0.70–1.06) for the whole cohort, 1.01 (95% CI, 0.77–1.33) for the group with low exposure to RF radiation (usual exposures well below 1 mW/cm²) and 0.71 (95% CI, 0.51–0.98) for the group with high exposure to RF radiation (potential for exposures up to 100 kW/cm², but usually less than 1 mW/cm²). Within the cohort, the relative risk (RR) of death from cancer of the brain in the group with high exposure to RF radiation relative to the group with low exposure was 0.65 (95% CI, 0.43–1.01). [This appeared to have been an initially somewhat poorly documented cohort, for which follow-up was difficult and some missing data, including birth date, had to be imputed. While expert assessment permitted division of the cohort into groups with low and high exposure to RF radiation, no specific measurements of exposure were reported. Assessment of exposure appeared to have been limited to 1950–54. Possible confounding factors, such as occupational exposure to other agents, were not addressed.]

In a cohort of 4417 Belgian male professional military personnel who served in battalions equipped with radar for anti-aircraft defence, cause-specific mortality was compared with that of 2932 Belgian military personnel who served in battalions not equipped with radar ([Degraeve et al., 2009](#)). Administrative archives of the battalions were used to reconstruct a list of personnel serving in each battalion. Lists were matched to those of the Department of Human Resources of the Belgian Army to find the subjects' birthdays, which allowed retrieval of their Belgian national identity number. With this number, mortality

follow-up could be conducted. For military personnel who died before 1979, the registry only recorded month and year of birth, and thus for 35 dead military exact birth-dates were not available, matching was equivocal and the cause of death was not used. The registry was complete until 1997 and from 1998 to 2004, only for the northern, Dutch-speaking part of Belgium. In parallel, for all professional military personnel who died up to 31 December 2004, first-degree family members were sought and a questionnaire sent to enquire about likely cause of death. For the period of follow-up of this study, the Belgian cancer registry was incomplete, but the information on cases of cancer reported to the registry was reliable. Thus the cancer registry was used only for confirmation, but not for identification of cancer cases. The risk ratio for deaths from cancers of the eye, brain and nervous system in the cohort serving in battalions equipped with radar compared with the unexposed cohort was 2.71 (95% CI, 0.42–17.49) ([Table 2.2](#)). [The Working Group noted the difficulties in following-up the study population that may have affected the study results, as well the difficulty of attributing any possible increase in risk ratio to exposure to RF radiation, given possible confounding due to ionizing radiation also emitted by devices producing MW radiation.]

2.1.2 Leukaemia and lymphoma

(a) Case-control studies

No data were available to the Working Group.

(b) Cohort studies

[Lilienfeld et al. \(1978\)](#) reported on a retrospective cohort study of USA employees, and their dependents, who had worked or lived at the United States embassy in Moscow during 1953–76 (see Section 2.1.1 for details). The total risk ratio for leukaemia in the embassy employees was 2.5 (95% CI, 0.3–9.0).

[Milham \(1988a, b\)](#) followed a cohort of people who were licensed as amateur radio operators between 1 January 1979 and 16 June 1984 (see Section 2.1.1 for details). There was a borderline excess risk of death from lymphatic and haematopoietic neoplasms, from acute myeloid leukaemia, and from multiple myeloma and lymphoma ([Table 2.3](#)). There was no evidence for an increase in SMR for these neoplasms with higher license class (see Section 2.1.1. for discussion of the strengths and weaknesses of this study).

[Armstrong et al. \(1994\)](#) conducted a nested case–control study of cancers at different sites within cohorts of electrical workers in Quebec, Canada, and in France (see Section 2.1.1 for details). There were no excess risks for all haematological cancers, non-Hodgkin lymphoma (NHL) or for all leukaemias, or for any of the subtypes of leukaemia, associated with exposure to PEMF ([Table 2.3](#)). [The strengths and weaknesses of this study are described in Section 2.1.1.]

The study by [Szmigielski \(1996\)](#) is described in detail in Section 2.1.1. A significantly increased incidence rate ratio for cancers of the haematological system and lymphatic organs was reported ([Table 2.3](#)). [The results were difficult to interpret, as there were many methodological flaws in the design and analysis of the study. Main issues were that exact data on the age of the subjects in the cohort were missing and that collection of exposure data was potentially differential.]

[Tynes et al. \(1996\)](#) followed a cohort of 2619 Norwegian women who were certified as radio and telegraph operators between 1920 and 1980. There was no elevation in risk of lymphoma or leukaemia for those potentially exposed to RF radiation ([Table 2.3](#)). [The strengths of this study are discussed in Section 2.1.1; its principal weaknesses were the small number of cancer cases and the probably low exposure of the cohort to RF radiation. Possible confounding factors were not addressed.]

[Lagorio et al. \(1997\)](#) reported on mortality from all causes and from specific cancers in a group of plastic sealers in Italy (see Section 2.1.1 for details). There was one death (0.2 expected) ascribed to leukaemia in an RF-sealer operator ([Table 2.3](#)). [The principal weakness of this study was its small size. Possible confounding factors were not addressed.]

[Morgan et al. \(2000\)](#) reported on a 20-year follow-up of 195 775 employees of Motorola USA (described in Section 2.1.1) and considered death from lymphatic and haematopoietic malignancies ([Table 2.3](#)). Of these, there were 87 deaths from leukaemia, 19 from Hodgkin disease and 91 from NHL. Reduced odds ratios for lymphatic and haematopoietic malignancies and subtypes were seen among workers categorized as exposed (compared with non-exposed workers) in most categories of estimated exposure, duration of exposure and cumulative exposure lagged 5, 10 and 20 years. [The Working Group noted the small number of deaths from lymphoma and leukaemia in the exposed cohort, which, together with the other limitations mentioned in Section 2.1.1, complicated the interpretation of these findings.]

[Richter et al. \(2000\)](#) collected data on six patients claiming compensation for their cancer who visited the Unit of Occupational and Environmental Medicine at the Hebrew University-Hatlawah Medical School, Jerusalem in 1992–99. They were judged to have received high RF/MW radiation based on self-reports, information from manuals containing specifications of the equipment they had used and repaired, and results of sporadic measurements from their work and medical records. A study was then conducted of 25 co-workers of one of the patients and of other personnel with self-reported exposure to RF radiation. An increased risk of haematolymphatic malignancies was found (5 cases observed compared with 0.02 cases expected among Jewish men aged 20–54 years). [The Working Group noted that the results of

this study were very difficult to interpret, due to unclear definition of the study population, follow-up and exposure assessment.]

[Groves *et al.* \(2002\)](#) reported on mortality in a cohort of 40 890 male United States Navy personnel who had served on ships during the Korean War in 1950–54 in an extended follow-up to 1997 (described in more detail in Section 2.1.1). The cohort was divided into two subgroups on the basis of job title, with potential exposure to RF radiation based on expert assessment: 20 109 workers comprising a subcohort with high exposure to RF radiation (potential for exposures up to 100 kW/cm², but usually < 1 mW/cm²) and a subcohort of 20 781 workers with low exposure (usually well below 1 mW/cm²). A total of 182 deaths from lymphoma or multiple myeloma (91 each in the high- and low-exposure subcohorts) and 113 deaths from leukaemia (44 and 69 in the high- and low-exposure subcohorts, respectively) were identified in 1950–97. In both subcohorts, SMRs were not elevated for lymphoma and multiple myeloma, all leukaemias, lymphocytic leukaemia or non-lymphocytic leukaemia ([Table 2.3](#)). An internal comparison of high relative to low exposure to RF radiation elicited RRs of 0.91 (95% CI, 0.68–1.22) for lymphoma and multiple myeloma, 1.48 (95% CI, 1.01–2.17) for all leukaemias, 1.82 (95% CI, 1.05–3.14) for non-lymphocytic leukaemia and 1.87 (95% CI, 0.98–3.58) for acute non-lymphocytic leukaemia. An increased risk of all leukaemias was observed primarily in aviation-electronics technicians (RR, 2.60; 95% CI, 1.53–4.43, based on 23 deaths) and was highest for acute myeloid leukaemia (RR, 3.85; 95% CI, 1.50–9.84, based on 9 deaths). RRs for other job categories with high exposure were close to 1. This was interpreted as indicating a possible association, since aviation-electronics technicians who dealt primarily with mobile radar units may have had more potential to enter the beam path of an operating radar than members of other groups who worked with ship-mounted radars. [The limitations of this study

are discussed in Section 2.1.1, including limitations in the documentation of the cohort definition and difficulties in follow-up. Classification of exposure to RF radiation in the different groups was based on expert assessment. No measurement of RF radiation was provided.]

[Degrave *et al.* \(2009\)](#) compared a cohort of 4417 Belgian male professional military personnel who served in battalions equipped with radars for anti-aircraft defence with 2932 Belgian male professional military personnel who served at the same time in the same place in battalions not equipped with radars. Attempts were made to characterize exposure levels on the site where the battalion lived and worked, but individual exposure assessment could not be conducted. Administrative archives of the battalions were used to reconstruct a list of personnel serving in each battalion. These archives only provided first name, family names, and a unique identification number. Lists were matched to those of the Department of Human Resources of the Belgian Army to find the subjects' birthdays, which allowed retrieval of their Belgian national identity number. With this number, mortality follow-up could be conducted. The first source of information on cause of death was the official Belgian death registry, which collects anonymous data. Linkage was conducted using date of birth and date of death as matching variables (cause of death could be found for 71% of persons in the radar group and 70% in the control group). For military personnel who died before 1979, the registry only recorded month and year of birth, and exact birth-dates were not available for 35 of the dead, while matching was equivocal and the cause of death was not used. The registry was complete until 1997 and from 1998 to 2004, only for the Northern, Dutch-speaking part of Belgium. In parallel, for all professional military personnel who died up to 31 December 2004, first-degree family members were sent a questionnaire to enquire about the likely cause of death. For the period of follow-up of this study,

Table 2.3 Cohort studies of leukaemia and occupational exposure to radiofrequency radiation

Reference, study location	Total No. of subjects	Follow-up period	Exposure assessment	Organ site (ICD code)	Exposure categories	No. of cases/deaths	Relative risk (95% CI)	Covariates	Comments
Lilienfeld et al. (1978)	7475	1953–76	Worked or lived in the United States embassy in Moscow during study period. The maximum measured levels were 5 µW/cm ² for 9 h/d, 15 µW/cm ² for 18 h/d, and < 1 µW/cm ² thereafter for non-overlapping periods 1953–1975 and 1975–1976	Leukaemia	Embassy employees		2.5 (0.3–9.0)	Sex, age	SMRs are relative to the corresponding mortality rates in the USA. Contract report is available through the National Technical Information Service of the USA.
Milham (1988a, b) USA	67 829	1979–1984	Licensing as an amateur radio operator	Lymphatic and haematopoietic cancers	All leukaemia AML Multiple myeloma and lymphoma All lymphatic and haematopoietic cancers	89 36 15 43	<i>SMR</i> 1.23 (0.99–1.52) 1.24 (0.87–1.72) 1.76 (1.03–2.85) 1.62 (1.17–2.18)		The death rates used to estimate the expected numbers were not specified
					<i>By licence class:</i>				
					Novice	9	1.01 [0.46–1.92]*		
					Technician	18	1.63 [0.97–2.58]*		
					General	26	1.19 [0.78–1.74]*		
					Advanced	27	1.15 [0.76–1.67]*		
					Extra	9	1.34 [0.61–2.54]*		

Table 2.3 (continued)

Reference, study location	Total No. of subjects	Follow-up period	Exposure assessment	Organ site (ICD code)	Exposure categories	No. of cases/deaths	Relative risk (95% CI)	Covariates	Comments
Armstrong et al. (1994) Canada and France	191 749	1970–89	Exposures assessed through a job-exposure matrix based on about 1000 person-weeks of measurements from exposure meters worn by workers to derive estimates of short-duration PEMFs, or high-frequency transient fields.	Haematological	<i>PEMFs</i> All haematological cancers: < Median > Median ≥ 90th percentile NHL: < Median > Median ≥ 90th percentile All leukaemias: < Median > Median ≥ 90th percentile	167 135 28 54 56 13 57 38 9	OR 1.00 0.90 (0.65–1.25) 0.96 (0.48–1.90) 1.00 1.41 (0.83–2.38) 1.80 (0.62–5.25) 1.00 0.69 (0.40–1.17) 0.80 (0.19–3.36)	SES	Nested case–control analysis Controls for each case were selected at random from the cases risk set, and matched to the case by utility and year of birth. Exposure was counted only up to the date of diagnosis of the case.
Szmigielski (1996) Poland	Average of 127 800 men, yearly during 15 yr	1971–85	Military safety (health and hygiene) groups classified military service posts as having exposure, or not, to RF	Cancer of the haematopoietic system and lymphatic organs	<i>Occupational exposure to RF</i> Not exposed Exposed	[131]* [24]*	Incidence rate ratios 1.00 6.31 (3.12–14.32)	None specified	Cross-sectional study
Tynes et al. (1996) Norway	2619 women	1961–91	Radio and telegraph operators with potential exposure to RF and ELF fields	Lymphoma (ICD-7 code 201) Leukaemia (ICD-7 code 204)	<i>Potential exposure</i> Lymphoma Leukaemia	5 2	<i>SIR</i> 1.3 (0.4–2.9) 1.1 (0.1–4.1)	Age, time since certification, calendar year, age at first childbirth	Women certified as radio and telegraph operators, 1920–80

Table 2.3 (continued)

Reference, study location	Total No. of subjects	Follow-up period	Exposure assessment	Organ site (ICD code)	Exposure categories	No. of cases/deaths	Relative risk (95% CI)	Covariates	Comments
Lagorio et al. (1997) Italy	481 women	1962–92	Occupational history from plant records. RF generated by dielectric heat sealers. Exposure of 10 W/m ² equivalent power-density frequently exceeded.	Leukaemia (204–208)	<i>Job title</i> RF-sealer operators Other workers All female workers	 1 1 2	SMR [5.0 (1.27–27.85)]* [11.1]* 8.0 (1.0–28.8)	Sex, age, calendar period-specific regional person-year at risk	Mortality analysis; restricted to women
Richter et al. (2000) Israel	Co-workers (<i>n</i> = 25) of one of the six patients claiming compensation for their cancer, and other personnel with self-reported exposure to RF	1992–99	Self-reports, information from manuals containing specifications of the equipment they had used and repaired, and results of sporadic measurements from their work and from medical records.	Haemato-lymphatic malignancies	Jewish men aged 20–54 yr	5	SIR [250 (81.17–583.42)]*	None	[The Working Group noted that the results of this study were very difficult to interpret, due to unclear definition of the study population, follow-up, and exposure assessment.]

Table 2.3 (continued)

Reference, study location	Total No. of subjects	Follow-up period	Exposure assessment	Organ site (ICD code)	Exposure categories	No. of cases/deaths	Relative risk (95% CI)	Covariates	Comments
Morgan et al. (2000) USA	195 775	1976–96	Job-exposure matrix, developed through expert consultation that categorized each of 9724 job titles into different RF exposure groups: background, low, moderate, and high, corresponding roughly to < 0.6 W, 0.6 to < 2.0 W, 2.0 to < 5.0 W, 5.0 to < 50 W and ≥ 50 W, respectively	All lymphatic/haematopoietic cancers (n = 203)	<i>Cumulative exposure to RF</i>		Rate ratio	Age, sex, and race for external comparisons; and age, sex, and period of hire for internal comparisons	All employees of Motorola; exposure from cellular telephones not assessed. Definition of exposure categories unclear
					None	148	1.00		
					< Median	21	0.74 (0.39–1.28)		
					> Median	34	0.67 (0.40–1.05)		
					<i>Usual exposure to RF</i>				
					None	152	1.00		
					Low	28	0.94 (0.57–1.47)		
					Moderate	10	0.90 (0.39–1.78)		
					High	8	0.70 (0.27–1.47)		
					<i>Peak exposure to RF</i>				
					None	145	1.00		
					Low	34	0.79 (0.49–1.23)		
					Moderate	11	0.58 (0.25–1.13)		
					High	10	0.60 (0.49–1.23)		
					<i>Duration of exposure</i>				
None	182	1.00							
≤ 5 yr	5	0.29 (0.12–0.57)							
> 5 yr	16	0.89 (0.55–1.35)							
<i>Cumulative exposure to RF</i>									
Males-low	109	1.00							
Males-high	19	0.53 (0.39–0.72)							
Females-low	60	1.00							
Females-high	15	1.12 (0.22–3.90)							

Table 2.3 (continued)

Reference, study location	Total No. of subjects	Follow-up period	Exposure assessment	Organ site (ICD code)	Exposure categories	No. of cases/deaths	Relative risk (95% CI)	Covariates	Comments
Groves et al. (2002) USA	40 581 men (271 women excluded)	1950–97	United States Navy personnel with potential exposure to RF; job classified as having low or high exposure by a consensus of Navy personnel involved in training and operation	All haematopoietic cancers (200–208)	<i>Job-associated exposure to RF</i> Lymphoma and multiple myeloma: All leukaemias: Lymphocytic leukaemia: Non-lymphocytic leukaemia:		SMR Low 91 0.94 (0.77–1.16) High 91 0.89 (0.72–1.09) Low 44 0.77 (0.58–1.04) High 69 1.14 (0.90–1.44) Low 17 1.31 (0.81–2.11) High 16 1.12 (0.69–1.83) Low 20 0.67 (0.43–1.04) High 39 1.24 (0.90–1.69)	Age at cohort entry and attained age	White (male) United States Navy veterans of Korean War (1950–54) Reference: all white men, USA Group of aviation-electronics technicians: RR 2.60 (1.53–4.43) for all leukaemias; RR 3.85 (1.50–9.84) for acute myeloid leukaemia

Table 2.3 (continued)

Reference, study location	Total No. of subjects	Follow-up period	Exposure assessment	Organ site (ICD code)	Exposure categories	No. of cases/deaths	Relative risk (95% CI)	Covariates	Comments
Degraeve et al. (2009) Belgium	Military personnel (4417 men) in battalions equipped with radar, and 2932 controls	1968–2003	Exposure levels on the site where the battalion lived and worked were characterized; individual exposure assessment could not be conducted.	Cancer of lymphatic and haematopoietic tissue (200–208)	Control cohort Radar exposed	1 11	1.00 7.22 (1.09–48.9)		Cause of death found for 71% of the men in the radar group and 70% in the control group

* values calculated/deduced by the Working Group

AML, acute myeloid leukaemia; ELF, extremely low frequency electric and magnetic field; MW, microwaves; NHL, non-Hodgkin lymphoma; OR, odds ratio; PEMFs, pulsed electromagnetic fields; RF, radiofrequency radiation; SES, socioeconomic status; SIR, standardized incidence ratio; SMR, standardized mortality ratio; W, watt; yr, year

the Belgian cancer registry was extremely incomplete, but the information on cases of cancer reported to the registry was reliable. Thus, the cancer registry was used only for confirmation but not for identification of cancer cases. The relative risks were estimated, adjusting for age in 10-year categories with a Poisson regression model. There were 11 deaths from lymphatic and haematopoietic neoplasms in the radar battalion compared with 1 in the unexposed cohort (RR, 7.22; 95% CI, 1.09–48.9) (Table 2.3). [The Working Group noted the difficulties in following-up the study population, which may have affected the study results, as well the difficulty in attributing any possible increase in relative risk to exposure to RF radiation, given possible confounding due to ionizing radiation also emitted by devices producing MW radiation.]

2.1.3 Uveal (ocular) melanoma

Stang *et al.* (2001) conducted population-based and hospital-based case-control studies of uveal melanoma and occupational exposures to different sources of electromagnetic radiation, including RF radiation. For the population-based study, 37 cases were identified by a reference pathologist (response rate, 84%) and 327 controls were sampled and matched from the same region of residence, age and sex (response rate, 48%). For the hospital-based study, the 81 cases were patients treated at the University of Essen (response rate, 88%) and controls ($n = 148$) were patients with benign intra-ocular tumours (response rate, 79%). The results of these studies were pooled. The 118 female and male cases and 475 controls were interviewed by a trained interviewer with a structured questionnaire involving medical history, lifestyle, occupation and occupational exposure to RF radiation. Participants were specifically asked about exposure to radar and to other RF-emitting devices (“Did you use radio sets, mobile phones or similar devices at your workplace for at least several hours per

day?”) and more detail was obtained from those who reported exposure. Additional information provided by exposed participants was used by two of the authors, working independently and unaware of case or control status, to classify them as: exposed only to radio receivers that do not transmit RF radiation and therefore unexposed; exposed to RF radiation from walkie-talkies and radio sets; possibly exposed to RF radiation from mobile phones; and probably or certainly exposed to RF radiation from mobile phones. Few participants reported occupational exposure to radar. The odds ratio for uveal melanoma was 0.4 (95% CI, 0.0–2.6). For exposure to radio sets, the odds ratio was 3.3 (95% CI, 1.2–9.2) (Table 2.4). Adjustment for socioeconomic status or iris/hair colour did not alter these results. The results for reported occupational use of mobile phones are considered in Section 2.3. [This study was weakened by its poor assessment of occupational exposure to RF radiation, particularly the retrospective classification of exposure to other RF-emitting devices, although neither should be a source of positive bias. Confounding of occupational exposure to RF radiation with exposure to ultraviolet light from the sun or other sources was not considered and may have been important if, for example, much of the use of radio sets had entailed use of walkie-talkie radios for communication outdoors.]

2.1.4 Cancer of the testis

(a) Case-control studies

Interpretable results were available from only two case-control studies (Table 2.5). Both were limited by reliance on self-report for exposure classification.

Hayes *et al.* (1990) carried out a case-control study in the USA examining associations of testicular cancer with occupation and occupational exposures. Cases ($n = 271$) were aged 18–42 years and diagnosed between 1976 and 1981 in three medical institutions, two of which

treated military personnel, while the controls ($n = 259$) were men diagnosed in the same centres with a cancer other than of the genital tract. A complete occupational history was taken and participants were also asked about specific exposures, including to radar equipment and to MW radiation, MW ovens or other radio-waves. For all cancers of the testis combined, the odds ratio associated with exposure to MW radiation, MW ovens or other radio-waves was significantly increased, while the odds ratio for exposure to radar equipment was not elevated (Table 2.5). The participants were further classified by an industrial hygienist as to degree of exposure to MW radiation, MW ovens, and other radio-waves and no indication of an exposure–response relationship was found. [The Working Group noted that the exposure-classification approach was based on self-report and was probably subject to substantial misclassification.]

Baumgardt-Elms *et al.* (2002) carried out a case–control study examining the association of cancer of the testis with workplace exposures to EMF. The histologically confirmed cases ($n = 269$; including 170 seminomas and 99 non-seminomas) were recruited between 1995 and 1997 from five German regions (response rate, 76%). The controls ($n = 797$) were randomly selected from mandatory registries of residents, with matching on age and region (response rate, 57%). Occupational exposure to EMF was assessed in standardized face-to-face interviews with closed questions. For radar, job descriptions were selected for participants who had reported exposure to radar or had worked in occupations and industries involving such exposures. The participants were classified as to exposure to radar on the basis of expert review and measurements conducted in Germany. There was no excess risk of cancer of the testis associated with being classified as having exposure to radar. [A comparison of self-report of exposure with classification by the expert panel showed substantial misclassification from reliance on self-report.]

(b) Cohort study

Davis & Mostofi (1993) reported six cases of cancer of the testis in a cohort of 340 police officers who used hand-held radar guns in the state of Washington, USA. Only one case was expected, based on national data. [The Working Group noted that the finding of the six cases as a cluster had sparked the investigation. Exposure assessments were not made for the full cohort.]

2.1.5 Other cancers

Armstrong *et al.* (1994) carried out a nested case–control study of the association between exposure to PEMFs and various cancers, including lung (described in Section 2.1.1). An association was observed between exposure to PEMFs and cancer of the lung (Table 2.6). The highest excess risk was found in cases first exposed 20 years before diagnosis. [The relevance of the measured EMF parameters to exposure to RF radiation was unclear.]

No association of RF radiation with cancer of the lung has been reported in other studies (Milham, 1988a; Szmigielski, 1996; Tynes *et al.*, 1996; Lagorio *et al.*, 1997; Morgan *et al.*, 2000; Groves *et al.*, 2002; Degraeve *et al.*, 2009; described in Section 2.1.1, and Table 2.6). A later overview by Szmigielski *et al.* (2001) reported an incidence rate ratio of 1.06 in the population studied by Szmigielski (1996), based on 724 not-exposed cases and 27 exposed cases.

Tynes *et al.* (1996) (described in Section 2.1.1) studied the impact of exposure to RF radiation (405 kHz to 25 MHz) in an occupational cohort of Norwegian female radio/telegraph operators who had worked at sea for extended periods. There were increased standardized incidence ratios (SIR) for cancers of the breast and uterus (Table 2.6). A nested case–control analysis for cancer of the breast was performed within this cohort. To control for the possible confounding effect of reproductive history, the investigators linked the cohort to a unique database from

the Norwegian Central Bureau of Statistics that contained information on the reproductive histories of Norwegian women born between 1935 and 1969. After adjusting for duration of employment, the odds ratio for cancer of the breast was 4.3 (95% CI, 0.7–26.0) in women aged ≥ 50 years who had performed a large amount of shift-work (> 3.1 – 20.7 category–years). Adjustment for shift-work and relevant reproductive history reduced the odds ratio for cancer of the breast to 1.1 (95% CI, 0.2–6.1) in those with the longest duration of employment. [The apparent excess risk of cancer of the breast in this cohort, based on high-quality databases and linkage, was not explained by reproductive history and could be potentially attributed to exposure to light at night.]

2.2 Environmental exposure from fixed-site transmitters

Ecological studies are considered to provide a lower quality of evidence than case–control or cohort studies, as they reflect the possibility of uncontrolled confounding and possible misclassification of exposure. With regard to exposure to RF radiation and its association with cancers of the brain, there appears to be little possibility of confounding by anything other than socio-demographic factors associated with diagnostic opportunity. For other cancer sites, confounding may be of greater concern.

Individual measurements of distance from a transmitter as a proxy for exposure are effectively ecological measures, in which the ecological unit includes everyone living at the same distance, or within a restricted range of distances, from the transmitter. Spot measurements will only be partly correlated with total exposure and even a personal exposure meter provides only an approximation of the dose of radiation absorbed by a specific tissue. Measurement of lifetime exposure is problematic regardless of the study design, particularly when there is a high level of

population mobility and measurements of exposure are not readily available for previous areas of residence.

The crucial issue is to what extent the exposure surrogate is associated with the radiation absorbed, since this modulates the statistical power of the study. Some studies have validated correlations between proxy measures, based either purely on distance or on a more sophisticated propagation model. In some cases the correlation has been estimated at approximately 60%, in others it is $< 10\%$, especially when based upon self-report of exposures ([Schmiedel *et al.*, 2009](#); [Viel *et al.*, 2009](#); [Frei *et al.*, 2010](#)). Hence it is difficult to assume that exposure classification based on distance-based proxy measurements is useful, unless validation measurements are included. Detailed modelling of field propagation shows that several parameters are potentially required.

2.2.1 Cancer of the brain

(a) Ecological studies

In several ecological studies, incidence or mortality rates of brain tumours have been compared between defined populations living close to television or radio broadcast stations or other RF radiation fixed-site transmitters or transmission towers.

[Selvin *et al.* \(1992\)](#) undertook a cross-sectional analysis in which the proportion of people aged < 21 years with cancer of the brain diagnosed between 1973 and 1978 living ≤ 3.5 km or > 3.5 km from a large MW transmission tower (Sutro Tower) in San Francisco, USA ($n = 35$) was compared with corresponding proportions from the 1980 USA census. The odds ratio for cancer of the brain and living ≤ 3.5 km from the tower was 1.16 [95% CI, 0.56–2.39]. [No possible confounding factors were considered, nor were the ambient levels of RF radiation in the compared areas documented.]

Table 2.4 Case-control study of uveal melanoma and occupational exposure to radiofrequency radiation

Reference, study location and period	Total cases	Total controls	Control source (hospital, population)	Exposure assessment	Organ site (ICD code)	Exposure categories	Exposed cases	Relative risk (95% CI)	Covariates	Comments
Stang <i>et al.</i> (2001) Germany, 1995–98	118 (37/81)	475	Population-based study: 327 controls sampled and matched from the same region of residence, age, and sex. Hospital-based study: controls were 148 patients with benign intraocular tumours.	Interviewer-administered structured questionnaire	Uveal melanoma	Radar units Radio set: Ever exposed Exposed ≥ 5 yr before Exposed for ≥ 3 yr	1 9 9 7	0.4 (0.0–2.6) 3.3 (1.2–9.2) 3.3 (1.2–9.2) 2.5 (0.8–7.7)	Age, sex, region, SES, colour of iris and hair	Results of the population-based study (37 cases) and the hospital-based study (81 cases) were pooled.

SES, socioeconomic status; yr, year

Table 2.5 Case-control studies of cancer of the testis and occupational exposure to radiofrequency radiation

Reference, study location and period	Total cases	Total controls	Control source (hospital, population)	Exposure assessment	Organ site (ICD code)	Exposure categories	Exposed cases	Odds ratio (95% CI)	Covariates	Comments
Hayes et al. (1990) USA, 1976–81	271	259	Non-genital cancer, diagnosed in same hospital	Interviews, including a complete occupational history. Participants were queried on specific exposures including radar equipment and MW radiation, MW ovens or other radio-waves. In-person interviews were held in the hospital with 69% of the cases and with 71% of the controls, and over the telephone at home with the rest of the cases and controls.	Testicular seminoma (<i>n</i> = 60) Other germinal (<i>n</i> = 206) Non-germinal (<i>n</i> = 5)	<i>Radar equipment</i>			Age	Self-reported exposure Two of the three centres treated military personnel Poor agreement between self-reporting and job title No response rates reported
						Seminoma	12	1.3 (0.6–2.8)		
						Other	30	1.1 (0.6–1.9)		
						Total	NR	1.1 (0.7–1.9)		
						<i>Other MW/RF</i>				
						Seminoma	7	2.8 (0.9–8.6)		
						Other	24	3.2 (1.4–7.4)		
						Total	NR	3.1 (1.4–6.9)		
						Based on job title:				
						None	116	1.0		
Low	10	2.3 (0.6–9.4)								
Medium	6	1.0 (0.3–3.8)								
High	12	0.8 (0.3–2.0)								

Table 2.5 (continued)

Reference, study location and period	Total cases	Total controls	Control source (hospital, population)	Exposure assessment	Organ site (ICD code)	Exposure categories	Exposed cases	Odds ratio (95% CI)	Covariates	Comments
Baumgardt-Elms <i>et al.</i> (2002) Germany, 1995–97	269	797	Controls were randomly selected from mandatory registries of residents, and matched on age and region (response, 57%).	Interviewer-administered standardized questionnaire	Testicular (170 seminoma and 99 non-seminoma)	<i>Radar units</i>	22	1.0 (0.60–1.75)		Exposure to RF weighted by duration and distance from source
						<i>RF emitters</i>	50	0.9 (0.60–1.24)		
						<i>Radar units</i>				
						0	251	1.0		
						> 0 to ≤ 45	7	1.4 (0.55–3.77)		
						> 45 to ≤ 135	4	0.5 (0.17–1.55)		
						> 135 to ≤ 2225	7	0.9 (0.36–2.19)		
						<i>RF emitters</i>				
						0	220	1.0		
						> 0 to ≤ 6	19	1.0 (0.56–1.74)		
						> 6 to ≤ 15	14	0.7 (0.38–1.35)		
> 15 to ≤ 102	16	0.9 (0.46–1.56)								

MW, microwave; NR, not reported; RF, radiofrequency radiation

Table 2.6 Cohort studies of cancers of the lung and other sites and occupational exposure to radiofrequency radiation

Reference, study location	Total No. of subjects	Follow-up period	Exposure assessment	Organ site (ICD code)	Exposure categories	No. of cases/deaths	Relative risk (95% CI)	Covariates	Comments		
Milham (1988a, b) USA	67 829	1979–84	Licensing as an amateur radio operator	Cancer of the respiratory system (160–163)	None	209	SMR, 0.66 (0.58–0.76)		The death rates used to estimate the expected numbers were not specified		
Armstrong et al. (1994) Canada and France	191 749	1970–89	Exposures assessed through a job-exposure matrix based on about 1000 person-wks of measurements from exposure meters worn by workers to derive estimates of short-duration PEMFs, or high-frequency transient fields.	Lung cancer (162)	<i>PEMFs</i>			OR	SES	Nested case-control analysis Controls for each case were selected at random from the cases risk set and matched to the case by utility and year of birth. Exposure was counted only up to the date of diagnosis of the case.	
					< Median	200	1.00				
					> Median	308	1.27 (0.96–1.68)				
					≥ 90th percentile	84	3.11 (1.60–6.04)				
					First exposed 0–20 yr before diagnosis:						
					< Median	198	1.00				
					> Median	273	1.48 (1.08–2.03)				
					≥ 90th percentile	67	1.80 (1.13–4.30)				
Szmigielski (1996) Poland	Average of 127 800 men, yearly during 15 yr	1971–85	Military safety (health and hygiene) groups classified military service posts as having exposure, or not, to RF	Cancer of the larynx and lung	<i>Occupational exposure to RF</i>		<i>Incidence rate ratios</i>	None specified	Cross-sectional study.		
					Not exposed	[420]*	1.00				
					Exposed	[13]*	1.06 (0.72–1.56)				
					<i>Potential exposure</i>		<i>SIR</i>				
					Lung	5	1.2 (0.4–2.7)				
					Breast	50	1.5 (1.1–2.0)				
Tynes et al. (1996) Norway	2619 women	1961–91	Radio and telegraph operators with potential exposure to RF and ELF fields	Lung (ICD-7 code 162)	Uterus (ICD-7 code 172)	12	1.9 (1.0–3.2)	Age, time since certification, calendar year, age at first childbirth	Women certified as radio and telegraph operators 1920–80		
				Breast (ICD-7 code 170)						50	1.5 (1.1–2.0)
				Uterus (ICD-7 code 172)						12	1.9 (1.0–3.2)

Table 2.6 (continued)

Reference, study location	Total No. of subjects	Follow-up period	Exposure assessment	Organ site (ICD code)	Exposure categories	No. of cases/deaths	Relative risk (95% CI)	Covariates	Comments
Lagorio et al. (1997) Italy	481 women	1962–92	Occupational history from plant records. RF generated by dielectric heat sealers. Exposure of 10 W/m ² equivalent power-density frequently exceeded.	Lung (162)	<i>Job title</i>		<i>SMR</i>	Sex, age, calendar period-specific regional person-yr at risk	Mortality analysis; restricted to women
					RF-sealer operators	1	[5 (1.27–27.85)]*		
					Other workers	0	-		
					All female workers	1	[3.3]*		
Morgan et al. (2000) USA	195 775	1976–96	Job-exposure matrix, developed through expert consultation that categorized each of 9724 job titles into different RF exposure groups: background, low, moderate, and high, corresponding roughly to < 0.6 W, 0.6 to < 2.0 W, 2.0 to < 5.0 W, 5.0 to < 50 W and ≥ 50 W, respectively.	Respiratory system cancer	<i>RF exposure</i>		<i>SMR</i>	Age, sex, and race for external comparisons; and age, sex, and period of hire for internal comparisons	All employees of Motorola; exposure from cellular phones not assessed. Definition of exposure categories unclear
					High and moderate	94	[approx. 0.8]*		

Table 2.6 (continued)

Reference, study location	Total No. of subjects	Follow-up period	Exposure assessment	Organ site (ICD code)	Exposure categories	No. of cases/deaths	Relative risk (95% CI)	Covariates	Comments	
Groves et al. (2002) USA	40 581 men (271 women excluded)	1950–97	United States Navy personnel with potential for RF exposure; job classified as having low or high exposure by a consensus of Navy personnel involved in training and operation	Trachea, bronchus and lung (162)	<i>Job-associated exposure to RF</i>		SMR	Age at cohort entry and attained age	White United States Navy (male) veterans of Korean War (1950–54) Reference: all white men, USA	
						Low	497			0.87 (0.79–0.94)
						High	400			0.64 (0.58–0.70)
Degraeve et al. (2009) Belgium	Military personnel (4417 men) in battalions equipped with radar, and 2932 controls.	1968–2003	Exposure levels on the site where the battalion lived and worked were characterized; individual exposure assessment could not be conducted.	Respiratory and intra-thoracic organs (160–169)	Control cohort Radar exposed	28 45	1.00 1.07 (0.66–1.71)		Cause of death found for 71% of the men in the radar group and 70% in the control group.	

* Values calculated/deduced by the Working Group

ELF, extremely low frequency electric and magnetic field; MW, microwaves; OR, odds ratio; PEMFs, pulsed electromagnetic fields; RF, radiofrequency radiation; SES, socioeconomic status; SIR, standardized incidence ratio; SMR, standardized mortality ratio; W, watt; V, volt; wk, week; yr, year

[Hocking et al. \(1996\)](#) studied incidence and mortality attributable to cancer of the brain (ICD-9 code 191) near three television and FM-radio broadcasting antennae located close together in Sydney, Australia. Exposure from these towers was to amplitude modulation (AM) at 100 kW and frequency modulation (FM) at 10 kW for signals at 63–215 MHz. Calculated power densities of RF radiation ranged from 8.0 $\mu\text{W}/\text{cm}^2$ near the tower to 0.2 $\mu\text{W}/\text{cm}^2$ at a distance of 4 km and 0.02 $\mu\text{W}/\text{cm}^2$ at 12 km. For cancer of the brain at all ages in three “inner ring” municipalities relative to six “outer-ring” municipalities, the rate ratio for incidence was 0.89 (95% CI, 0.71–1.11; 740 cases) and the rate ratio for mortality was 0.82 (95% CI, 0.63–1.07; 606 deaths). [Municipality-specific incidence rates were only available in broad, sex-specific age groups: 0–14, 15–69 and ≥ 70 years]. For children aged 0–14 years, the corresponding rate ratios were 1.10 (95% CI, 0.59–2.06; 64 cases) and 0.73 (95% CI, 0.26–2.10; 30 deaths). All municipalities were said to have upper middle-class populations.

Prompted by reported clustering of leukaemia and lymphoma near a high-power television and FM-radio broadcast antenna in the West Midlands, England, [Dolk et al. \(1997a\)](#) studied the incidence of cancer within a radius of 10 km from the antenna. The authors noted that available field-strength measurements generally showed a decrease of the average field strength with increasing distance from the transmitter, although with undulations in predicted field strength up to about 6 km from the transmitter. The maximum total power-density equivalent summed across frequencies at any one measurement point was 0.013 W/m^2 for television, and 0.057 W/m^2 for FM radio. Observed numbers of cases within 0–2 km and 0–10 km of the antenna were compared with “national” incidence rates, adjusted for age, sex, year and deprivation quintile (calculated based on data on unemployment, overcrowding, and social class of head of

household). For all tumours of the brain (ICD-8/ICD-9 codes 191, 192, 225, and ICD-9 codes 237.5, 237.6, 237.9) in persons aged ≥ 15 years, the SIR was 1.29 (95% CI, 0.80–2.06) within 0–2 km and 1.04 (95% CI, 0.94–1.16) within 0–10 km. For malignant tumours of the brain only, these SIRs were 1.31 (95% CI, 0.75–2.29) and 0.98 (95% CI, 0.86–1.11), respectively.

[Dolk et al. \(1997b\)](#) undertook a similar analysis of cancer incidence in proximity to all 20 other high-power radio and television transmitter antennae in the United Kingdom. [With one exception, information about field distribution and strength in proximity to those antennae was not provided.] In this analysis, results for tumours of the brain were reported only for children aged 0–14 years and in proximity to all 21 such antennae (including that studied by [Dolk et al., 1997a](#)). At 0–2 km from the antenna, SIRs were 0.62 (95% CI, 0.17–1.59) for all tumours of the brain and 0.50 (95% CI, 0.10–1.46) for malignant tumours, while at 0–10 km SIRs were 1.06 (95% CI, 0.93–1.20) and 1.03 (95% CI, 0.90–1.18), respectively.

[Ha et al. \(2003\)](#) studied the incidence of cancer between November 1993 and October 1996 in people aged ≥ 10 years in populations of 11 administrative areas of the Republic of Korea within about 2 km of high-power (≥ 100 kW) AM transmitter antennae, 31 such areas within about 2 km of low-power AM transmitter antennae (50 kW), and 4 control areas near, but not within 2 km, of each high-power transmitter antenna (44 control areas in total). Incident cases of cancer were ascertained from medical insurance records [no information was given regarding the completeness and accuracy of these records]. Directly age-standardized incidence rate ratios for cancer of the brain (ICD-9 codes 191–192, and ICD-10 codes C70–C72) comparing people living near high-power transmitter antennae with people living near low-power antennae were 1.8 (0.9–11.1) in males and females combined. Indirectly age-standardized incidence rate

ratios for cancer of the brain comparing people living near high-power transmitter antennae at different levels of power output with those in control areas were 2.27 (95% CI, 1.30–3.67) for a power output of 100 kW, 0.86 (95% CI, 0.41–1.59) for 250 kW, 1.47 (95% CI, 0.84–2.38) for 500 kW, and 2.19 (95% CI, 0.45–6.39) for 1500 kW.

[Park et al. \(2004\)](#) reported the results of a similar study of cancer mortality in 1994–95 in people of all ages in the Republic of Korea. Mortality rates within an area of 2 km surrounding AM broadcasting towers with a power of > 100 kW were compared with those in control areas that had a similar population and were located in the same province as the matched exposed area. Information on deaths due to cancer was identified in Korean death certificates from 1994 to 1995. The resident population at that time was assumed to correspond to that recorded in the nationwide population census of 1990. To control for possible selection bias, four control areas ($n = 40$) were matched to each exposed area ($n = 10$). Based on six age groups, annual age-adjusted world population-standardized mortality rates were calculated per 100 000 residents. Mortality rate ratios (MRR) were calculated comparing 10 areas within about 2 km of high-power antennae with 40 areas situated > 2 km from high-power antennae in the same or neighbouring provinces. The directly standardized MRR for cancer of the CNS, comparing areas near high-power antennae with control areas, was 1.52 (95% CI, 0.61–3.75).

The incidence of cancer in relation to mobile-phone base-station coverage was investigated in 177 428 people living in 48 municipalities in Bavaria, Germany, between 2002 and 2003 ([Meyer et al., 2006](#)). Municipalities were classified on a crude three-level exposure scale based on the operating duration of each base station and the proportion of the population living within 400 m of the base station. Based on 1116 malignant tumours in 242 508 person-years, no indication of an overall increase in the incidence of cancer

was found in the populations of municipalities belonging to the highest exposure class. The Potthoff-Whittinghill test was used to examine the homogeneity of the case distribution among the communities. The following cancers were not found to be heterogeneously distributed: breast ($P = 0.08$); brain and CNS ($P = 0.17$); and thyroid ($P = 0.11$). For leukaemia, there were indications of underreporting and thus the test for homogeneity was not performed. [The exposure assessment in this study was very crude and likely to result in substantial random exposure misclassification. The number of organ-specific tumours was not reported, but is expected to be small given the total number of tumours. Thus, the observed absence of an association may be real, or due exposure misclassification, or to inadequate statistical power.]

(b) Case-control studies

[Schüz et al. \(2006b\)](#) reported on the association of proximity of a DECT (Digital Enhanced Cordless Telecommunications) cordless-phone base station to a person's bed (a proxy for continuous low-level exposure to RF radiation during the night) with the risk of brain glioma and meningioma in a case-control study in Germany that was a component of the INTERPHONE study. This was a subanalysis of the main study in which no association of either brain glioma or meningioma with use of cordless phones had been found ([Schüz et al., 2006a](#)). Cases were newly diagnosed with a histologically confirmed glioma or meningioma in 2000–03, aged 30–69 years, lived in the study region, had a main residence in the study region, and had a knowledge of German sufficient for interview. Proxy interviews were conducted if the cases or controls had died or were too ill for interview. Controls were selected randomly from compulsory population registers in the study regions, were required to meet relevant case-inclusion criteria, and were initially frequency-matched to the cases by age, sex and region. Participation rates were: patients

with glioma, 79.6%; patients with meningioma, 88.4%; and controls, 62.7%. Interview questions about cordless phones addressed the type of phone (DECT or analogue), make and model, the dates on which use started and stopped, and the location of the base station within the residence. Since many subjects could not recall whether their cordless phone was a DECT phone, information on the make, model and price of the phone and its technical features were used to classify phones into “definitely” or “possibly” DECT, or definitely analogue. Participants were considered definitely or possibly exposed if, in addition, the DECT base station was located 3 m or less from the bed (this was the case for 1.6% of participants). Information from proxy interviews (patients with glioma, 10.9%; patients with meningioma, 1.3%; and control participants, 0.4%) was used in the analysis, since most proxies lived with their index subjects and were users of the same cordless phones. For analysis, controls were individually matched 2 : 1 to cases by birth year, sex, region and date of diagnosis (case) or interview (control); 366 cases of glioma and 381 cases of meningioma were analysed. Risk of glioma or meningioma was not increased with definite or possible exposure to DECT base stations; nor was there any consistent trend with time since first exposure ([Table 2.7](#)). [This study was limited by the small proportion of people who were considered to be exposed, difficulty in classifying cordless phones as DECT or analogue, and lack of associated consideration of other sources of exposure to RF radiation.]

[Ha et al. \(2007\)](#) reported on risk of childhood cancers of the brain in relation to residential exposure to RF radiation from AM-radio fixed-site transmitters (power, > 20 kW) in the Republic of Korea. Cases were diagnosed with cancer of the brain (ICD-9 codes 191–192, and ICD-10 codes C70–C72) between 1993 and 1999, and controls were diagnosed over the same period with a respiratory disease (ICD-9 codes 469–519, and ICD-10 codes J20 and J40–J46). Both cases

and controls were identified through the national health insurance system of the Republic of Korea, and individually matched by age, sex and year of first diagnosis. Both were restricted to children diagnosed at one of fourteen large cancer or tertiary-care hospitals. Cancer diagnoses were confirmed by reference to the national cancer registry or hospital medical records [the basis for confirmation was not stated]. Cases were excluded if the diagnosis of cancer could not be confirmed; controls were excluded if they had a history of cancer recorded in the national cancer registry (which was 80% complete in 1998); and both were excluded if they had incomplete addresses (which were obtained from the medical records). The distance from each subject’s residence to the nearest AM-radio transmitter established before diagnosis was evaluated by means of a geographical information system, and total exposure to RF radiation from all AM-radio fixed-site transmitters was estimated with a flat-earth attenuation statistical-prediction model, which took into account features of the receiving point and the propagating pathway [intervening terrain, the output power of the fixed-site transmitters and their distance from the receiving point]. The prediction program was validated by taking measurements of field strength at sites around 11 fixed-site transmitters, and correction coefficients were calculated and applied to the prediction program. Twenty-nine of the thirty-one radio fixed-site transmitters were established between 1980 and 1995, and children in the study were born between 1978 and 1999. Socioeconomic status was classified according to the number of cars owned per 100 people in defined regions and population density in these regions was used as a surrogate for industrialization and environmental pollution. The odds ratio for cancer of the brain was not materially increased in those living closest (≤ 2 km) to a transmitter (OR, 1.42; 95% CI, 0.38–5.28) or in those with greatest estimated exposure (≥ 881 mV/m) to RF radiation (OR, 0.77; 95% CI, 0.54–1.10) ([Table 2.7](#)). [This

Table 2.7 Case-control studies of cancer of the brain and environmental exposure to radiation from transmitters of radiofrequency signals

Reference, study location and period	Total cases	Total controls	Control source (hospital, Population)	Exposure assessment	Organ site (ICD code)	Exposure categories	Exposed cases	Odds ratio (95% CI)	Comments
Schüz et al. (2006b) Bielefeld, Heidelberg, Mainz, Mannheim, Germany, 2000–03	747	1494	Population	Interviewer-administered questionnaire	Brain (glioma and meningioma)	<i>DECT cordless-phone base station ≤ 3m from bed</i>			Covariates: age, sex, region, educational level
						Glioma			
						<i>Definitely</i>			
						No	342	1.00	
						Yes	3	0.50 (0.14–1.76)	
						<i>Possibly or definitely</i>			
						No	342	1.00	
						Yes	5	0.82 (0.29–2.33)	
						<i>Time since first exposure (possibly or definitely)</i>			
						No, < 1 yr	342	1.00	
						1–4 yr	3	0.95 (0.24–3.70)	
						≥ 5 yr	2	0.68 (0.14–3.40)	
						Meningioma			
						<i>Definitely</i>			
						No	360	1.00	
Yes	5	1.09 (0.37–3.23)							
<i>Possibly or definitely</i>									
No	364	1.00							
Yes	5	0.83 (0.29–2.36)							
<i>Time since first exposure (possibly or definitely)</i>									
No, < 1 yr	364	1.00							
1–4 yr	1	0.33 (0.04–2.80)							
≥ 5 yr	4	1.29 (0.37–4.48)							

Table 2.7 (continued)

Reference, study location and period	Total cases	Total controls	Control source (hospital, Population)	Exposure assessment	Organ site (ICD code)	Exposure categories	Exposed cases	Odds ratio (95% CI)	Comments
Ha et al. (2007) Republic of Korea, 1993–99	956	1020	Hospital-based study. Controls had attended one of 14 large cancer or tertiary care hospitals where the cases had been diagnosed, for management of respiratory disease (ICD-9 469–519; ICD-10 J20 and J40–46). Controls were individually matched to a case by age, sex, and year of first diagnosis.	Based on locations of 31 AM transmitters of ≥ 20 kW and 49 associated antennae and locations of subjects' residences at time of diagnosis.	Brain (ICD-9 code 191–192; ICD-10 codes C70–C72)	<i>Distance from nearest AM radio-transmitter established before subject's year of diagnosis (km)</i>	All brain cancer (age < 15 yr)		Children aged < 15 yr. The use only of large hospitals for ascertainment of controls could mean that controls are not representative of population from which cases were drawn. Covariates: age, sex, residential location, population density, SES
						≤ 2	10	1.42 (0.38–5.28)	
						> 2–4	32	1.40 (0.77–2.56)	
						> 4–6	59	1.02 (0.66–1.57)	
						> 6–8	90	1.08 (0.73–1.59)	
						> 8–10	114	0.94 (0.67–1.33)	
						> 10–20	244	1.01 (0.77–1.34)	
						> 20	400	1.00 (reference)	
						Unknown	7	4.30 (0.50–36.73)	
						<i>P (trend)</i>		0.76	
						<i>Total exposure to RF (mV/m)</i>			
						< 532.55*	329	1.00 (reference)	
						532.55 – < 622.91	185	0.66 (0.47–0.92)	
622.91 – < 881.07	181	0.72 (0.51–1.01)							
≥ 881.07	254	0.77 (0.54–1.10)							
<i>P (trend)</i>		0.73							

*Quartiles of the distribution

Table 2.7 (continued)

Reference, study location and period	Total cases	Total controls	Control source (hospital, Population)	Exposure assessment	Organ site (ICD code)	Exposure categories	Exposed cases	Odds ratio (95% CI)	Comments
Ha et al. (2007) (cont.)						<i>Distance from nearest AM radio-transmitter established before subject's year of diagnosis (km)</i>	All brain cancer (age < 1 yr)		
						≤ 10	10	0.41 (0.05–3.10)	
						> 10–20	10	0.49 (0.06–3.80)	
						> 20	12	1.00 (reference)	
						<i>P (trend)</i>		0.78	
						<i>Total exposure to RF (mV/m)</i>			
						< 485.85*	9	1.00 (ref.)	
						485.85 – < 632.96	7	3.56 (0.49–25.95)	
						632.96 – < 810.81	7	1.41 (0.12–17.11)	
						≥ 810.81	9	5.13 (0.44–60.26)	
						<i>P (trend)</i>		0.27	

[Oberfeld \(2008\)](#)
Hausmannstätten
& Vasoldsberg,
Austria, 1984–97

The status of this study (printed version, German and English online versions) is controversial. It was therefore decided to remove the description of this study from text and tables.

Table 2.7 (continued)

Reference, study location and period	Total cases	Total controls	Control source (hospital, Population)	Exposure assessment	Organ site (ICD code)	Exposure categories	Exposed cases	Odds ratio (95% CI)	Comments
Spinelli et al. (2010) Western Provence-Alpes-Côte d'Azur (PACA), France, 2005	122	122	Hospital-based	Self-administered questionnaire and face-to-face interview, including lifetime job history, job title, dates, tasks	Brain (glioma grades II–IV)	<i>Residence within 500 m of:</i> Cell-phone tower	19	0.49 (0.26–0.92)	Covariates: age, sex
Elliott et al. (2010) United Kingdom, 1999–2001	251	1004	Population-based study. Controls were children aged < 4 yr, individually matched to cases by sex and date of birth.	Location of birth residence relative to nearby macro-cell mobile-phone base stations; distance to nearest base station; total power output of all base-stations within 700 m; modelled power density at birth address	Brain and CNS (ICD-10 codes C71–C72)	<i>Distance from nearest macro-cell mobile-phone base-station</i> Lowest third Intermediate third Highest third <i>For 15th to 85th centile increase (continuous measure)</i> <i>Total mobile-phone frequency power-output (kW)</i> No base station within 700 m Lower half Upper half <i>For 15th to 85th centile increase (continuous measure)</i>	85 85 81 251 150 56 45 251	1.00 0.95 (0.67–1.34) 0.95 (0.65–1.38) 1.12 (0.91–1.39) 1.00 1.02 (0.72–1.46) 0.83 (0.54–1.25) 0.89 (0.73–1.09)	Covariates: percentage of population with education to degree level or higher, Carstairs score (a composite area-deprivation measure), population density, and population mixing (percentage immigration into the area over the previous year).

Table 2.7 (continued)

Reference, study location and period	Total cases	Total controls	Control source (hospital, Population)	Exposure assessment	Organ site (ICD code)	Exposure categories	Exposed cases	Odds ratio (95% CI)	Comments
Elliott <i>et al.</i> (2010) (contd.)						<i>Modelled mobile-phone frequency power density (dBm)</i>			
						Lowest third	93	1.00	
						Intermediate third	80	0.97 (0.69–1.37)	
						Highest third	78	0.76 (0.51–1.12)	
						For 15th to 85th centile increase (continuous measure)	251	0.82 (0.55–1.22)	

AM, amplitude modulation (radio); CNS, central nervous system; DECT, Digital Enhanced Cordless Telecommunications; kW, kilowatt; NMT, Nordic Mobile Telephone (standard); RF, radiofrequency radiation; SES, socioeconomic status; yr, year

study was limited by the lack of a clear population base, possible mismatch between the population sampled for cases and that sampled for controls, and the lack of a cumulative measure of exposure to RF radiation that took into account variation in an individual's place of residence between birth and diagnosis of cancer or respiratory disease.]

[[Oberfeld \(2008\)](#): the status of this study (printed version, German and English online versions) is controversial. It was therefore decided to remove the description of this study from text and tables.]

[[Spinelli et al. \(2010\)](#) undertook a pilot case-control study of newly diagnosed, histopathologically confirmed malignant primary tumours of the brain (defined as previously untreated glioma, grades II–IV) in people aged ≥ 18 years treated in the two principal referral hospitals for cancer of the brain in the west of the Provence-Alpes-Côte d'Azur (PACA) region in France. Controls were other patients in the neurosurgery department who were hospitalized for reasons other than cancer (mainly herniated intervertebral disc, intracranial aneurysm, trauma, and epidural haematoma) who were individually matched to cases by age, sex and residence in the west of PACA. Participants completed a self-administered questionnaire and were interviewed by an occupational physician at the hospital they attended within 3 months after surgery; the physician also checked their questionnaire. [It was not stated whether the interviewer was blind to the case or control status of participants.] Family members also helped with self-administered questionnaires, more often for cases than controls. Proxy interviews were completed for 2% of cases. Occupational exposures were the principal focus of the questionnaire and interview, but participants were also asked about use of mobile phones and residence in proximity to a mobile-phone tower. Information was obtained from 75.3% of cases [the participation rate of controls was not stated]. Nineteen cases and thirty-three

controls reported a mobile-phone tower within 500 m of their residence (age- and sex-adjusted OR, 0.49; 95% CI, 0.26–0.92) ([Table 2.7](#)). [This study was limited by its small size and because it was hospital-based. The participation rate for controls was not stated and it is likely that people prone to serious injury were over-represented among the controls. The interviewer may not have been blind to the case or control status of participants. Specific questions regarding proximity of residence to mobile-phone towers were not described and may have been highly prone to recall error, and there were few participants with occupational exposure to RF radiation.]

[[Elliott et al. \(2010\)](#) undertook a case-control study of early childhood cancer in the United Kingdom based on all cases of cancer in children aged 0–4 years registered in 1999–2001. Of 1926 registered cases, the geographical coordinates of addresses at birth, and exposure based on the birth address were available for 1397 children (73%). Of the latter, 251 had cancers of the brain and CNS (ICD-10 codes C71–C72). For each case, four controls from the national birth register, with complete birth addresses and individually matched to cases by sex and date of birth (5588 controls), were obtained from 6222 originally randomly selected (90%). The four national mobile-phone operators provided detailed data on all 76 890 macro-cell base stations operating in 1996–2001. Three exposure measures for the birth address of each case and control were obtained: the distance from the nearest macro-cell mobile-phone station; the total power output (kW) from summation across all base stations within 700 m; and computed modelled power density (dBm) at each birth address for base stations within 1400 m. Exposures beyond 1400 m were considered to be at background levels. Measurements from field campaigns in a rural and an urban area were used to set parameter values in the power-density model. The models were validated with data from two further surveys and power-density measurements from 620 locations

across the country. Spearman's correlation coefficients between measured power density and the exposure measures were: 0.66 with modelled power density, 0.72 with distance from nearest base station, and 0.66 with total power output. The exposure measures estimated at each birth address were averaged across monthly estimates for the assumed 9 months of the pregnancy in each case. Each exposure measure was divided into thirds of the distribution across all cases and controls except for total power output, which was zero for 58% (no base station within 700 m), with the remaining 42% in two halves of their distribution. Exposure measures were fitted to models as continuous variables as well as in the above categories. Neither unadjusted nor partly or fully adjusted odds ratios suggested that risk of childhood cancer of the brain increased with increasing exposure to RF radiation from nearby macro-cell mobile-phone base stations (Table 2.7). [This study was limited by the fact that estimation of exposure was confined to the gestational period; application of birth address to the whole of gestation was assumed; and ecologically measured possible confounding variables were used to apply to individual subjects.]

(c) Cohort studies

No data were available to the Working Group.

2.2.2 Leukaemia and lymphoma

(a) Ecological studies

See Table 2.8

Hocking *et al.* (1996) published a study comparing incidence of and mortality from leukaemia during 1972–90 in nine municipalities, three of which were located around television towers and six that were more distant. Increased rate ratios for incidence (IRR, 1.24; 95% CI, 1.09–1.40) and mortality (MRR, 1.17; 95% CI, 0.96–1.43) for leukaemia at all ages were obtained and generally higher rate ratios were seen for childhood leukaemia (IRR, 1.58; 95%

CI, 1.07–2.34; MRR, 2.32; 95% CI, 1.35–4.01) than for leukaemia at all ages, comparing the three “inner ring” municipalities with six “outer ring” municipalities. A more marked association was observed between proximity to television towers and mortality (MRR, 2.4; 95% CI, 1.4–3.7) than incidence (IRR, 1.8; 95% CI, 1.2–2.5) from leukaemia. [No individual measurements were undertaken and main analyses could only be adjusted for covariates by group-level (aggregated) data.]

In 1997, Dolk *et al.* published two studies on cancer incidence during 1974–86. The first was a study in a small area in response to an unconfirmed report of a cluster of leukaemias and lymphomas near the Sutton Coldfield television and radio-transmitter in the West Midlands, England (Dolk *et al.*, 1997a). The second, to place in context the findings of the Sutton Coldfield study, was carried out near 20 high-power television and radio-transmitters in the United Kingdom (Dolk *et al.*, 1997b). In the Sutton Coldfield study, an increased risk of leukaemia in adults was found when the observed and expected numbers of cases (derived from national incidence rates) were compared (observed/expected, 1.83; 95% CI, 1.22–2.74) within 2 km of the transmitter and there was a decline in risk with distance (Stone's *P* value = 0.001). The latter was tested by use of 10 bands of increasing distance from the transmitter within a circle with a radius of 10 km around it. The findings appeared to be consistent between 1974 and 1980, and 1981 and 1986. For NHL, a suggestion of a decrease in risk was seen within the 2 km area (observed/expected, 0.66; 95% CI, 0.28–1.30) while for the total study area of 0–10 km, risk appeared to be increased (observed/expected, 1.23; 95% CI, 1.11–1.36). In the second study, covering the United Kingdom (Dolk *et al.*, 1997b), evidence of a decline in risk of leukaemia was found with increasing distance from the transmitter (Stone's *P* value = 0.05); however, the magnitude (at 0–10 km: observed/expected, 1.03; 95% CI, 1.00–1.07) and the pattern

Table 2.8 Ecological studies of leukaemia and lymphoma and environmental exposure to radiation from transmitters of radiofrequency signals

Reference, study location	Total No. of subjects	Follow-up period	Exposure assessment	Organ site (ICD code)	Exposure categories	No. of cases/deaths	Relative risk (95% CI)	Covariates	Comments
Hocking et al. (1996) Australia	585 000	1972–90	Residential proximity to TV towers	Leukaemia (204–208)	Overall rate ratios for incidence and mortality, respectively, inner and outer residential area compared. Inner area vs ref. population Outer area vs ref. population Inner area vs ref. population Outer area vs ref. population	1206/847 33 101 19 40	Incidence, 1.24 (1.09–1.40) Mortality, 1.17 (0.96–1.43) Childhood SIR, 1.8 (1.2–2.5) Childhood SIR, 1.1 (0.9–1.4) Childhood SMR 2.4 (1.4–3.7) Childhood SMR 1.0 (0.7–1.4)	Age, sex, calendar period	Reference population: whole of New South Wales
Dolk et al. (1997a) United Kingdom	Around 408 000	1974–86	Distance to Sutton Coldfield radio and TV transmitter	Haematopoietic and lymphatic cancers (200–202; 203 + 238.6; 204–208) Leukaemia (204–208) NHL	Distance 0–2 km Distance 0–10 km Stone's <i>P</i> -value Distance 0–2 km Distance 0–10 km Stone's <i>P</i> -value Distance 0–2 km Distance 0–10 km Stone's <i>P</i> value	45 935 23 304 8 357	1.21 (0.91–1.62) 1.04 (0.98–1.11) Unconditional <i>P</i> = 0.153 1.83 (1.22–2.74) 1.01 (0.90–1.13) Unconditional <i>P</i> = 0.001 Conditional <i>P</i> = 0.001 0.66 (0.28–1.30) 1.23 (1.11–1.36) Unconditional <i>P</i> = 0.005 Conditional <i>P</i> = 0.958	Region	Observed/expected ratios and Stone's <i>P</i> -value are given for persons aged ≥ 15 yr, stratified by age, sex, year, and SES. Declining risk with increasing distance was seen only for all leukaemias.

Table 2.8 (continued)

Reference, study location	Total No. of subjects	Follow-up period	Exposure assessment	Organ site (ICD code)	Exposure categories	No. of cases/deaths	Relative risk (95% CI)	Covariates	Comments
Dolk <i>et al.</i> (1997b) United Kingdom	Around 3 390 000	1974–86	Distance to radio and television transmitters in the United Kingdom (excluding Sutton Coldfield)	Leukaemia (204–208)	Distance 0–2 km Distance 0–10 km Stone's <i>P</i> value	79 3 305	0.97 (0.78–1.21) 1.03 (1.00–1.07) Unconditional <i>P</i> = 0.001 Conditional <i>P</i> = 0.052	Region	Observed/expected ratios and Stone's <i>P</i> value are given for persons aged ≥ 15 yr, stratified by age, sex, year, and SES.
Cooper <i>et al.</i> (2001) United Kingdom	NR	1987–94	Distance to Sutton Coldfield television transmitter	Leukaemia (204–208)	Distance from transmitter: 0–2 km, all ages, all persons 0–10 km, all ages, all persons Stone's <i>P</i> values, all ages, all persons 0–2 km, age 0–14 yr, all persons 0–10 km, age 0–14 yr, all persons Stone's <i>P</i> values, age 0–14 yr, all persons	 20 333 1 26	 1.32 (0.81–2.05) 1.16 (1.04–1.29) Unconditional <i>P</i> = 0.038 Conditional <i>P</i> = 0.409 1.13 (0.03–6.27) 1.08 (0.71–1.59) Unconditional <i>P</i> = 0.420	-	Observed/expected ratios and Stone's <i>P</i> values (unconditional and conditional) are given. Stratified by age, sex, and social deprivation. Results for other haematopoietic cancers are reported in the manuscript.

Table 2.8 (continued)

Reference, study location	Total No. of subjects	Follow-up period	Exposure assessment	Organ site (ICD code)	Exposure categories	No. of cases/deaths	Relative risk (95% CI)	Covariates	Comments
Michelozzi et al. (2002) Italy	49 656	1987–99	Distance to Vatican radio station, Rome	Leukaemia (204–208)	Distance from radio station (km), (cumulative areas)			Deprivation index	
					<i>Total (age > 14 yr)</i>		SMR		
					0–2	2	1.8 (0.3–5.5)		
					0–4	11	1.5 (0.8–2.6)		
					0–6	23	1.2 (0.8–1.8)		
					0–8	34	1.2 (0.8–1.6)		
					0–10	40	1.1 (0.8–1.4)		
					<i>P, Stone's conditional test</i>		0.14		
					<i>Children (age 0–14 yr)</i>		SIR		
					0–2	1	6.1 (0.4–27.5)		
					0–4	3	2.9 (0.7–7.6)		
					0–6	8	2.2 (1.0–4.1)		
					0–8	8	1.5 (0.7–2.7)		
					0–10	8	1.2 (0.6–2.3)		
					<i>P, Stone's conditional test</i>		0.036		

Table 2.8 (continued)

Reference, study location	Total No. of subjects	Follow-up period	Exposure assessment	Organ site (ICD code)	Exposure categories	No. of cases/deaths	Relative risk (95% CI)	Covariates	Comments	
Ha et al. (2003) Republic of Korea	From 3 152 to 126 523 persons per area (total not given)	1993–96	Distance ≤ 2 km from AM transmitter	Leukaemia (204–208)	<i>High-power (≥ 100 kW) vs low-power (50 kW) transmitter sites:</i>		<i>Rate ratio</i>	Age	Rate ratios (RR) and observed/expected (O/E) ratios are given For all cancers combined: RR, 1.2 (95% CI, 1.1–1.4) for high- vs low-power transmitters	
						Men	8.3/6.8 per 100 000 person-yr			1.2 (0.5–5.3)
						Women	8.7/4.6 per 100 000 person-yr			1.9 (0.8–8.7)
						Total	8.5/5.7 per 100 000 person-yr			1.5 (0.7–6.6)
							<i>Transmitter power of sites:</i>			<i>O/E</i>
						100 kW	9			1.20 (0.55–2.28)
						250 kW	12			2.45 (1.27–4.29)
500 kW	10	0.65 (0.31–1.19)								
	1500 kW	4	4.26 (1.16–10.89)							

Table 2.8 (continued)

Reference, study location	Total No. of subjects	Follow-up period	Exposure assessment	Organ site (ICD code)	Exposure categories	No. of cases/deaths	Relative risk (95% CI)	Covariates	Comments
Ha et al. (2003) (contd.)				Malignant lymphoma (200–202)	<i>High-power (≥ 100 kW) vs low-power (50 kW) transmitter sites:</i>		<i>Rate ratio</i>		
					Men	10.5/7.1 per 100 000 person-year	1.5 (0.7–8.6)		
					Women	8.7/7.1 per 100 000 person-year	1.2 (0.6–5.6)		
					Total	9.6/7.1 per 100 000 person-year	1.4 (0.6–7.0)		
					<i>Transmitting power of sites:</i>		<i>O/E</i>		
					100 kW	9	1.10 (0.51–2.10)		
					250 kW	13	1.28 (0.68–2.19)		
					500 kW	16	0.98 (0.56–1.59)		
					1 500 kW	1	0.44 (0.01–2.48)		

Table 2.8 (continued)

Reference, study location	Total No. of subjects	Follow-up period	Exposure assessment	Organ site (ICD code)	Exposure categories	No. of cases/deaths	Relative risk (95% CI)	Covariates	Comments	
Park et al. (2004) Republic of Korea	8 115 906 (of whom 1 234 123 in exposed area)	1994–95	Regions including AM-radio broadcasting towers of > 100 kW	Leukaemia (ICD-10 codes C90–95), including multiple myeloma	Total exposed vs control (unexposed)	55	1.70 (0.84–3.45)	Age	Direct standardized MRRs are given	
					Males	33	1.89 (0.75–4.75)			
					Females	22	1.55 (0.52–4.68)			
					Age (yr)					
					0–14	11	2.29 (1.05–5.98)			
					15–29	11	2.44 (1.07–5.24)			
					30–44	9	2.16 (0.95–4.04)			
					45–59	5	0.73 (0.48–2.89)			
					60–74	10	0.87 (0.57–2.78)			
					≥ 75	6	3.08 (0.95–6.59)			
					Malignant lymphoma (ICD-10 codes C81–88)	Total exposed vs control (unexposed)	31			1.60 (0.72–3.56)
						Males	19			1.52 (0.56–4.14)
						Females	12			1.80 (0.48–6.71)
						Age (yr)				
						0–14	1			2.46 (0.07–82.66)
						15–29	2			1.51 (0.15–15.18)
30–44	5	1.94 (0.37–10.20)								
45–59	8	1.76 (0.43–7.15)								
60–74	13	1.41 (0.47–4.14)								
≥ 75	2	0.55 (0.05–5.67)								

AM, amplitude modulation (radio); kW, kilowatt; MRR, mortality rate ratio; NR, not reported; O/E, observed/expected; SIR, standardized incidence ratio; SMR, standardized mortality ratio; TV, television; vs, versus; yr, year

of risk seen in the Sutton Coldfield study could not be replicated. Most notably, in the second, nationwide study no increase in risk was seen nearest (within 2 km) the transmitters.

In a letter to the editor, [Cooper et al. \(2001\)](#) published updated results on adult and childhood leukaemia (1987–94) near the Sutton Coldfield transmitter. To investigate risk according to distance, the authors defined the study area as a series of 10 concentric circles around the Sutton mast and calculated the expected number of cases (by numbers, child/adult and sex) for each of the circles and for different cancer sites. Most results for childhood cancers gave no evidence of a decline in the ratios of observed-to-expected numbers of cases with distance from the transmitter. There was some support for a decline in risk of childhood leukaemia in males, as indicated by Stone's test. The risk also declined for acute myeloid leukaemia in adult females, for all leukaemias (females and all persons separately), and for haematopoietic and lymphatic cancers in females. The same four groups were at higher risks over the whole study area (0–10 km). An increased risk was found for acute lymphatic leukaemia within 2 km of the transmitter; however this was based on only two cases. Elevated risks were found for leukaemias and NHL (males and females combined and separately) over the whole study area. No increase or decrease in the ratios of observed-to-expected numbers of cases was seen for NHL.

[Michelozzi et al. \(2002\)](#) published a study on incidence and mortality for adult and childhood leukaemia in an area of 10 km around a high-power radio station in Rome. This station had numerous transmitters with different transmission powers (5–600 kW) operating at different frequencies (short–medium wave). An increased incidence of childhood leukaemia (SIR, 2.2; 95% CI, 1.0–4.1) was found up to 6 km from the radio station; there was a decline with increasing distance from the station for mortality in males and for incidence from childhood leukaemia.

[The small number of cases, possible unmeasured confounding and lack of individual or calculated exposure assessment were some limitations of the study.]

[Ha et al. \(2003\)](#) published a study on the incidence of cancer in the Republic of Korea in 1993–96 in areas proximate to 42 AM-radio-transmitters, characterized by transmission power. An increased rate ratio comparing sites exposed to high-power versus low-power transmitters was seen for all cancers combined (rate ratio, 1.2; 95% CI, 1.1–1.4), while confidence intervals by cancer type were wide, e.g. for leukaemia (rate ratio, 1.5; 95% CI, 0.7–6.6) and malignant lymphoma (rate ratio, 1.4; 95% CI, 0.6–7.0). However, at two of eleven high-power sites, more pronounced increases in the incidence of leukaemia were found. [Interpretation was hampered by limitations related to the ecological design, study size, exposure and outcome assessment, and lack of controls for confounding. There was partial overlap in the populations included in [Park et al. \(2004\)](#) and [Ha et al. \(2007\)](#).

[Park et al. \(2004\)](#) published a study that evaluated cancer mortality in the Republic of Korea in relation to exposure to AM-radio-transmitters. Mortality from leukaemia was higher in exposed areas than in control areas (standardized mortality rate ratio, MRR, 1.70; 95% CI, 0.84–3.45), particularly among young adults (MRR, 2.44; 95% CI, 1.07–5.24), but also in children (MMR, 2.29; 95% CI, 1.05–5.98). According to the authors, however, there was no increasing or decreasing trend with respect to broadcasting power. [In this study, exposure assessment was poor (no individual data) and it was also unclear to what extent the mortality records reflected the true address of the subject, which was used as a proxy for exposure. Other limitations were the lack of control for confounding by socio-economic status, and possible non-differential disease misclassification.]

(b) Case-control studies

See [Table 2.9](#)

[Maskarinec et al. \(1994\)](#) published the results of a small case-control study that indicated an increased incidence in childhood leukaemia (SIR, 2.09; 95% CI, 1.08–3.65) near radio towers in Hawaii, USA. The SIR for acute lymphocytic leukaemia was 1.58 (95% CI, 0.63–3.26) and for acute non-lymphocytic leukaemia it was 3.75 (95% CI, 1.20–8.71). Seven cases of leukaemia had been reported during 1982–84, including all five cases of acute non-lymphocytic leukaemia (SIR, 5.34; 95% CI, 2.14–11.0) that were unusual with respect to sex, age, and type of leukaemia. Twelve cases in children aged < 15 years diagnosed with acute leukaemia in 1979–90 and residing in certain census tracts before diagnosis were included in the case-control study, along with 48 (80%) sex- and age-matched controls that lived in the same area at the time of diagnosis. Collection of data was by non-blinded telephone interviews with parents, which included questions on pregnancy, address, and residence history, the child's medical history and exposure of various kinds, including X-rays and smoking. In addition, the occupational history of both parents was recorded, together with potentially relevant exposures. The odds ratio for acute leukaemia among those having lived within 2.6 miles (4.2 km) of the radio towers before diagnosis was increased (OR, 2.0; 95% CI, 0.6–8.3). [The limitations of this study, besides poor assessment of exposure, were its low power to detect an effect (~50% for OR = 5) and the apparent lack of controls for confounding by socioeconomic status.]

[Ha et al. \(2007, 2008\)](#) published the results of a case-control study that was large enough to give moderate statistical power for detecting an effect of exposure to RF radiation on the risk of childhood leukaemia. Patients aged < 15 years with leukaemia and controls with respiratory illnesses were selected from 14 hospitals in the

Republic of Korea and matched on age, sex and year of diagnosis (1993–99). From a total of 1928 cases of leukaemia and matched controls, risks were estimated by means of conditional logistic regression analysis adjusted for residential area, socioeconomic status and community population density. An increased risk of all types of leukaemia was found among children who lived within 2 km of the nearest AM-radio-transmitter (OR, 2.15; 95% CI, 1.00–4.67). For total exposure to RF radiation, most odds ratios decreased with predicted exposure. The authors reported an odds ratio of 1.40 (95% CI, 1.04–1.88) for lymphocytic leukaemia and 0.63 (95% CI, 0.41–0.97) for myelocytic leukaemia in the quartile of highest peak exposure, although no linear trend was evident with regard to the different exposure categories for total or peak exposure to RF radiation. [The main limitations of the study were related to the exposure estimates calculated by the prediction programme, e.g. the existence of buildings or irregular geographical features was not considered, nor was individual cumulative-exposure history assessed. There was partial overlap in the populations included in [Ha et al. \(2003\)](#) and [Park et al. \(2004\)](#).]

A case-control study on RF radiation and childhood leukaemia was conducted in west Germany by [Merzenich et al. \(2008\)](#). Cases (age, 0–14 years) diagnosed during 1984–2003 and registered at the German Childhood Cancer Registry were included, along with three age-, sex- and transmitter-area-matched controls per case that were drawn randomly from population registries. The analysis included 1959 cases and 5848 controls for which individual exposure to RF radiation 1 year before diagnosis was estimated by means of a field-strength prediction program. The study area encompassed municipalities in the vicinity of Germany's strongest transmitters, including 16 AM and 8 FM transmitters with a power of at least 20 kW. Conditional logistic regression analysis for all types of childhood leukaemia yielded no increase in odds ratio (OR,

Table 2.9 Case-control studies of leukaemia and lymphoma and environmental exposure to radiation from transmitters of radiofrequency signals

Reference, study location and period	Total cases	Total controls	Control source (hospital, population)	Exposure assessment	Organ site (ICD code)	Exposure categories	Exposed cases	Odds ratio (95% CI)	Covariates	Comment
Maskarinec et al. (1994) Hawaii, USA, 1984–2003	12	48	Hospital	Having lived within 2.6 miles of low-frequency radio towers. Distances estimated both manually and by use of a geographical software package	Acute leukaemia (7 ALL, 5 ANLL)	Last residence before diagnosis within 2.6 miles [4.2 km] of radio towers.	8	2.0 (0.6–8.3)		Matched ORs are given; matching variables: age, sex
						Residence at birth within 2.6 miles of radio towers	8	2.2 (0.3–15)		
						Residence with the maximum number of years within 2.6 miles of radio towers	8	1.8 (0.5–6.3)		
Ha et al. (2007) Republic of Korea, 1993–99	1928	3082	Hospital	Prediction program incorporating a geographic information system	All leukaemia (204–208)	<i>Distance (km)</i>			Residential location, population density, SES	Conditional logistic regression; matching variables: age, sex, year of diagnosis. Cases aged < 15 yr. Corrected estimates for total RF exposure according to Ha et al. (2008)
						> 20	772	1.00		
						≤ 2	36	2.15 (1.00–4.67)		
						> 2–4	73	0.66 (0.44–0.99)		
						> 4–6	120	1.07 (0.77–1.49)		
						> 6–8	218	1.26 (0.96–1.65)		
						> 8–10	276	1.10 (0.85–1.41)		
						> 10–20	428	0.80 (0.65–0.99)		
						Unknown	5	0.48 (0.12–1.95)		
<i>P</i> for trend		0.10								

Table 2.9 (continued)

Reference, study location and period	Total cases	Total controls	Control source (hospital, population)	Exposure assessment	Organ site (ICD code)	Exposure categories	Exposed cases	Odds ratio (95% CI)	Covariates	Comment
Ha et al. (2007) (contd.)						<i>Total exposure to RF (mV/m), quartiles (Q)</i>				In category Q4: OR for LL was 1.40 (95% CI, 1.04–1.88), and for ML, 0.63 (95% CI, 0.41–0.97)
						Q1	737	1.00		
						Q2	362	0.75 (0.58–0.97)		
						Q3	330	0.70 (0.55–0.90)		
						Q4	494	0.83 (0.63–1.08)		
						Unknown	5	0.39 (0.10–1.54)		
						<i>P for trend</i>		0.44		
Merzenich et al. (2008) Germany, 1984–2003	1959	5848	Population	Field-strength prediction programme	ICCC Ia, ICCC Ib, ICCC Ic, ICCC Id, ICCC Ie	<i>Quantiles of median exposure (V/m) to RF-EMFs (AM and FM/TV transmitter) one yr before diagnosis of case</i>				Conditional logistic regression; matching variables age, sex, year of diagnosis, study region. Cases were aged 0–14 yr.
						0 to < 90%	1772	1.00		
						90 to < 95%	101	1.02 (0.80–1.31)		
						95 to ≤ 100%	86	0.86 (0.67–1.11)		
						<i>Distance (km), AM or FM/TV transmitter</i>				
						10 to < 15	551	1.00		
						0 to < 2	25	1.04 (0.65–1.67)		
						2 to < 6	172	0.81 (0.66–0.99)		
						6 to < 10	314	0.79 (0.67–0.93)		
						≥ 15	866	1.00 (0.88–1.14)		

Table 2.9 (continued)

Reference, study location and period	Total cases	Total controls	Control source (hospital, population)	Exposure assessment	Organ site (ICD code)	Exposure categories	Exposed cases	Odds ratio (95% CI)	Covariates	Comment	
Elliott <i>et al.</i> (2010) United Kingdom, 1999–2001	527	5588	Population	(a) Distance from nearest mobile phone base station; (b) Total power output from summation across all base stations within 700 m; (c) Modelled power density at each birth address for base stations within 1400 m	Leukaemia and NHL (C91–95, C82–85)	<i>Distance from nearest base station (m)</i>				Percentage of population with education to degree level or higher, Carstairs deprivation score, population density, population mixing	Conditional logistic regression; matching variables: age, sex. Cases aged 0–4 yr
						Lowest	182	1.00			
						Intermediate	167	0.99 (0.78–1.27)			
						Highest	178	1.05 (0.81–1.35)			
						<i>P</i> for trend		0.75			
						<i>Total power output (kW)</i>					
						Lowest	305	1.00			
						Intermediate	112	1.08 (0.84–1.38)			
						Highest	110	1.08 (0.80–1.42)			
						<i>P</i> for trend		0.58			
						<i>Modelled power density (dBm)</i>					
						Lowest	179	1.00			
Intermediate	179	1.16 (0.90–1.48)									
Highest	169	1.03 (0.79–1.34)									
<i>P</i> for trend		0.51									

ALL, acute lymphocytic leukaemia; AM, amplitude modulation; ANLL, acute non-lymphocytic leukaemia; dBm, modelled power density; FM, frequency modulation; ICC, International Classification of Childhood Cancer; kW, kilowatt; LL, lymphocytic leukaemia; ML, myelocytic leukaemia; OR, odds ratio; NHL, non-Hodgkin lymphoma; RF, radiofrequency radiation; SES, socioeconomic status; TV, television

0.86; 95% CI, 0.67–1.11) when the upper and lower quantiles of RF-radiation distribution were compared. In addition, there was no evidence for an association indicating increased or decreased risk by transmitter type or leukaemia subtype. Nor was there any increased risk (OR, 1.04; 95% CI, 0.65–1.67) for children residing within 2 km of the nearest transmitter. [Lack of information on peak and indoor exposure to RF radiation as well as cumulative lifetime exposure to RF radiation from transmitters, and the low number of cases residing within 2 km of the nearest AM transmitters were the main limitations of this study.]

A case–control study by [Elliott *et al.* \(2010\)](#) (described in Section 2.2.1) examined risk of childhood cancers (e.g. leukaemia and NHL) in association with maternal exposure to RF radiation from mobile-phone base stations during pregnancy. No association or trend for different exposure categories was found for leukaemia or NHL with any of the exposure metrics used. Sociodemographic measures as well as mean distance of birth address from nearest FM, television, and very high frequency (VHF) broadcast antennae were similar for cases and controls. [Although this study had strengths in its size, national coverage and sophisticated exposure assessment compared with previous studies, it was carried out during years when mobile-phone use had become fairly common, yet such usage was not accounted for.]

(c) Cohort studies

No data were available to the Working Group.

2.2.3 Other cancers

There have been several small ecological studies, generally of low quality, that have assessed the correlation between all cancers and distance from mobile-phone base stations ([Eger *et al.*, 2004](#); [Wolf & Wolf, 2004](#); [Gavin & Catney, 2006](#); [Eger & Neppe, 2009](#)). However, the

Working Group considered these studies to be uninformative for the reasons listed below.

Three ecological studies considered risk of all cancers in relation to sources of exposure to RF. [Wolf & Wolf \(2004\)](#) studied the incidence of all cancers around one base station located south of Netanya, Israel, which began operating in July 1996. Among the population of 622 people living within 350 m from the antenna, eight cases were identified between July 1997 and June 1998, and the rate of all cancers among these people was compared to the national rates of cancer in Israel (ratio of rates, 4.15; no confidence intervals provided). [The Working Group considered this study to be uninformative for various reasons, including its small size, unclear method of case ascertainment, crude analyses including incidence rate computed without age standardization, and other methodological limitations.]

Prompted by a reported clustering of cancer cases around a communication mast in Cranlome, Northern Ireland, an ecological study of cancer risk was carried out during 2001–02 ([Gavin & Catney, 2006](#)). The mast was erected in 1989, and was taken down in 2002. The Northern Ireland Cancer Registry was the source of case ascertainment. The rates of incidence of groups of cancer in several concentric geographical areas (up to 5 km) were compared with national rates of cancer incidence. The SIR for all cancers was 0.94 (95% CI, 0.88–0.99) for men and 1.00 (95% CI, 0.94–1.06) for women, while the SIR was 101 (95% CI, 79–104) for brain and 99 (95% CI, 74–124) for lymphoma and leukaemia. [The Working Group considered this study to be uninformative due to its small size, the fact that the number of cases was not reported and the absence of evaluation of exposure to RF radiation.]

[Eger *et al.* \(2004\)](#) studied the incidence of all cancers between 1994 and 2003 in areas determined by circles of radius 400 m around two mobile-phone base stations located in Naila, Germany. The first base station became operational in 1993 and the second in 1997. Streets

within and without the area were randomly selected, and the patient databases of general practitioners were searched for cases living the entire period of 10 years at the same address. [The completeness of the ascertainment appeared to be 90%.] The proportion of new cases of cancer was significantly higher among those patients who had lived for the past 10 years at a distance of up to 400 m from the cellular transmitter site, compared with patients living further away. [The Working Group considered this study uninformative due to the small and ill-defined study base and crude statistical methodology.] The same authors investigated the incidence of cancer around a mobile-phone base station in Westphalia, Germany, between 2000 and 2007 ([Eger & Neppe, 2009](#)). Twenty-three cases were identified by door-to-door interviews. The authors compared the incidence of all cancers in the 5 years immediately after installation of the mast to that in later years, and found a statistically significant increase in incidence 5 years after the base station started transmission. [The Working Group considered this study to be uninformative due to its small size and crude statistical methodology.]

Five additional studies ([Dolk et al., 1997a, b](#); [Ha et al., 2003](#); [Park et al., 2004](#); [Meyer et al., 2006](#)) described information on additional cancer sites ([Table 2.10](#), and see Section 2.2.1). [The interpretation of these results was limited by the small numbers and crude exposure classification.]

2.3 Exposure from mobile phones

With continuing changes in technology, use of mobile phones has become widespread over the last two decades. As a result, the population exposed to RF radiation has greatly increased and is still expanding, with more and more children among its number. Over these two decades, there has been rising concern regarding the potential health risks associated with use of mobile phones, particularly the possibility of increased

risk of cancer of the brain. These concerns have stimulated a diverse programme of research, including epidemiological studies carried out to assess the association of mobile-phone use with risk of cancer of the brain and other diseases. The strength of epidemiological studies is obviously the capacity to directly assess the risks associated with use of mobile phones in the general population; however, the observations collected in these studies clearly only address the various exposure scenarios that existed up to the time of observation. Thus the studies carried out to date include few participants who have used mobile phones for > 10–15 years. Any risks that might be associated with lengthier exposure or with a longer interval since first exposure would not be captured by existing studies.

Three types of study design have been applied to address the question whether an increased risk of cancer is associated with RF emitted by mobile phones. These are ecological studies (in particular, observations of time trends in disease rates), case-control studies, and cohort studies. The strengths and limitations of each of these designs in general have been well described. Here, the Working Group focused on the characteristics of these designs as applied to the investigation of the potential risks of mobile-phone use.

Ecological studies provide only indirect evidence on the potential risks associated with mobile-phone use. The general approach involves comparison of time trends in mobile-phone use with time trends in disease indicators, assessing whether the trends are parallel, and allowing for a potential lag in relationships. Over the last few decades, several factors have affected trends in incidence and mortality for cancer of the brain, in particular, the increasing availability of sensitive imaging technology (computed tomography, CT, and magnetic resonance imaging, MRI) for detecting cancers of the brain, which is likely to have had a variable influence on changes in diagnostic practices, depending on country. Consequently, the interpretation of time trends is

Table 2.10 Ecological studies of other cancers and environmental exposure to radiation from transmitters of radiofrequency signals

Reference, study location	Total No. of subjects	Follow-up period	Exposure assessment	Organ site (ICD code)	Exposure categories	No. of cases/deaths	Relative risk (95%CI)	Covariates	Comments			
Dolk <i>et al.</i> (1997a) United Kingdom	Around 408 000	1974–86	Distance to Sutton Coldfield radio and TV transmitter	All cancers	Distance 0–2 km Distance 0–10 km Stone's <i>P</i> value	703	1.09 (1.01–1.17)	Region				
						17 409	1.03 (1.02–1.05)					
							Unconditional <i>P</i> = 0.001					
							Conditional <i>P</i> = 0.462					
						Skin melanoma	0–2 km			13	1.43 (0.83–2.44)	
						Eye melanoma				0	0 (0–4.22)	
						Male breast				1	1.64 (0.04–9.13)	
						Female breast				107	1.08 (0.90–1.31)	
						Lung				113	1.01 (0.84–1.21)	
						Colorectal				112	1.13 (0.94–1.35)	
						Stomach				33	0.75 (0.54–1.06)	
						Prostate				37	1.13 (0.82–1.55)	
						Bladder				43	1.52 (1.13–2.04)	
						Skin melanoma	0–10 km			189	0.96 (0.83–1.11)	Region
						Eye melanoma				20	1.16 (0.75–1.80)	
						Male breast				15	0.99 (0.60–1.64)	
						Female breast				2412	1.05 (1.01–1.10)	
						Lung				3466	1.01 (0.98–1.05)	
						Colorectal				2529	1.03 (0.99–1.07)	
Stomach		1326	1.06 (1.01–1.12)									
Prostate		785	1.03 (0.96–1.11)									
Bladder		788	1.08 (1.01–1.16)									
Dolk <i>et al.</i> (1997b) United Kingdom	Around 3 390 000	1974–86	Distance to radio and TV transmitters in United Kingdom (excluding Sutton Coldfield)	Skin melanoma Bladder	0–2 km	51	1.11 (0.84–1.46)	Region				
						209	1.08 (0.94–1.24)					
						Skin melanoma	0–10 km			1540	0.90 (0.85–0.94)	
						Bladder				8307	1.09 (1.06–1.11)	

Table 2.10 (continued)

Reference, study location	Total No. of subjects	Follow-up period	Exposure assessment	Organ site (ICD code)	Exposure categories	No. of cases/deaths	Relative risk (95%CI)	Covariates	Comments
Ha et al. (2003) Republic of Korea	From 3 152 to 126 523 persons per area (total not given)	1993–96	kW	Breast cancer	High-power (≥ 100 kW) vs low-power (50 kW) transmitter sites	39.7/33.6 per 100 000 person-years	1.2 (0.8–1.7)	Age	
				Breast cancer	Sites with transmitter power:				
					100 kW	29	1.29 (0.86–1.86)		
					250 kW	20	0.88 (0.54–1.36)		
					500 kW	41	0.90 (0.64–1.23)		
	1500 kW	3	2.19 (0.45–6.39)						
Park et al. (2004) Republic of Korea	8 115 906	1993–95	Regions including AM-radio broadcasting towers of > 100 kW	All cancer	Total exposed vs control (unexposed)	6191	1.29 (1.12–1.49)	Age	Direct standardized MRRs are given.
				Oral cavity and pharynx		14	1.21 (0.41–3.57)		
				Oesophagus		49	1.20 (0.71–2.03)		
				Stomach		403	1.18 (0.96–1.44)		
				Colorectum including anus		78	1.33 (0.83–2.11)		
				Liver, including intrahepatic duct		271	1.01 (0.80–1.27)		
				Pancreas		74	1.52 (0.97–2.39)		
				Lung, including trachea		232	1.08 (0.84–1.38)		
				Thyroid		7	1.35 (0.22–8.19)		
				Breast		22	1.38 (0.63–3.02)		
				Bone and connective tissue		8	1.05 (0.21–5.22)		
				Urinary bladder		16	1.13 (0.48–2.65)		
Skin		8	1.72 (0.36–8.21)						

Table 2.10 (continued)

Reference, study location	Total No. of subjects	Follow-up period	Exposure assessment	Organ site (ICD code)	Exposure categories	No. of cases/deaths	Relative risk (95%CI)	Covariates	Comments
Meyer et al. (2006) Germany	177 428 persons living in 48 municipalities in Bavaria		Presence of mobile-telephone relay stations, classified into three categories of relay-station coverage	Breast Brain and CNS Thyroid		NR	NR		Incidence of all cancers combined was not found to be elevated in municipalities with mobile-telephone relay stations. Specific cancers not heterogeneously distributed

AM, amplitude modulation; CNS, central nervous system; kW, kilowatt; MRR, mortality rate ratio; NR, not reported; TV, television

complicated. Nonetheless, the ecological studies provide evidence for consideration in the assessment of the coherence of a causal association of mobile-phone use with cancer of the brain.

The critical evidence comes primarily from case–control studies, as only few cohort studies have been carried out. The basic design of most case–control studies reviewed in this section has involved interviews with cases (most studies are of cancer of the brain) and with appropriate controls; the interviews characterize use of mobile phones, exposures to other sources of RF radiation (e.g. cordless phones) in some instances, potential confounding factors, and other information. The critical methodological concerns around interpretation of the findings of case–control studies of mobile-phone use involve the comparability of cases and controls, the potential for selection bias, and information bias, particularly in ascertainment of exposure to RF radiation from mobile-phone use. Confounding is a less serious concern because, apart from age, the only well-established causal factor for cancer of the brain is ionizing radiation, and also because in the general population the distribution of exposures, primarily from diagnostic irradiation, is unlikely to introduce substantial confounding.

Information bias related to exposure assessment has been a principal concern in interpreting the findings of case–control studies. The investigators have developed interview and questionnaire approaches for ascertaining mobile-phone use and exposure characteristics that attempt to capture the full exposure profile. Key exposure metrics have included the duration of use, call frequency, and cumulative use indicators, the types of device used, and various potential modifiers of exposure, such as use of a hands-free device and the laterality of use. With this approach, some degree of non-differential (random) misclassification of exposure to RF radiation is unavoidable. In studies of the association between protracted exposures and risk of cancer, a related concern is that the key exposure

metrics used may not capture the etiologically relevant period of a person's exposure profile (for example, if the effect of a hazard does not persist indefinitely, or appears only after an induction and latency period). Additionally, as in any case–control study, there is the possibility of differential recall according to case status regarding mobile-phone use and other items. Such bias may be in the direction of underreporting, if, for example, cases with tumours of the brain had diminished cognitive function. The bias may be in the direction of over-reporting if, for example, cases were more likely to recall events that might have led to their disease. A validation study carried out with the INTERPHONE Study demonstrated non-differential information bias, as well as the possibility of greater recall of temporally remote use by cases compared with controls ([Vrijheid et al., 2009a, b](#)). There is the additional possibility that the degree of measurement error varies from study to study, depending on the interview approach and other factors. While random misclassification generally reduces associations, differential misclassification may increase or decrease observed associations from the “true” underlying association.

Selection bias may also affect the results. Selection bias from two sources is of potential concern: specifically, differential participation by cases and controls that is determined by factors influencing likelihood of exposure. Additional selection bias can arise from the process used to select cases and controls, such that the association is distorted from that in the underlying population. This bias is of particular concern in case–control studies involving cases selected from hospitals or other medical institutions, as the factors that lead to hospitalization and diagnosis may also be associated with the exposure(s) under investigation. Selection bias may reduce or increase the observed association.

In interpreting the results of the case–control studies, consideration was given to the net consequences of selection bias and information

bias to answer the question as to whether the observed association(s) could reflect bias (at least in part), rather than causation. The judgment of the Working Group as to the potential consequences of bias was critical to the classification of the evidence from humans. The complexities in interpretation of the findings of case–control studies of mobile phones and cancer of the brain have been reviewed recently ([Ahlbom *et al.*, 2009](#); [Saracci & Samet, 2010](#)).

2.3.1 Cancer of the brain

(a) Ecological studies

Multiple ecological studies have been published that compare time trends in use of mobile phones and incidence and mortality rates of various cancers, primarily brain ([Table 2.11](#)). [Because these studies provided only limited and indirect evidence on the risk of cancer potentially associated with mobile-phone use, the Working Group presented a brief synthesis only.] These included two time-trend studies ([Lönn *et al.*, 2004](#); [Deltour *et al.*, 2009](#)) in the combined Nordic countries, two in the United Kingdom ([Nelson *et al.*, 2006](#); [de Vocht *et al.*, 2011a](#)), three in parts of the USA ([Muscat *et al.*, 2006](#); [Propp *et al.*, 2006](#); [Inskip *et al.*, 2010](#)), one each in Japan ([Nomura *et al.*, 2011](#)), New Zealand ([Cook *et al.*, 2003](#)), Switzerland ([Röösli *et al.*, 2007](#)) and Israel ([Czerninski *et al.*, 2011](#)), and one in a set of eleven countries ([Saika & Katanoda, 2011](#)). Most studies provided some data on the temporal pattern of increasing use of mobile phones, based mostly on annual numbers of private subscriptions and, in a few instances, on estimated prevalence of use. The information on use of mobile phones clearly demonstrated the rapid increase between 1985 and 2000; in some countries, the increase started in about 1990, while in others the increase began later in that decade. In some countries, the reported number of subscriptions had approached the total population of the country in 2000. The number of subscriptions is

a surrogate for population exposure to RF radiation, but the number does not reflect temporal changes in patterns of actual usage. Most of these ecological studies had used rates of cancer incidence calculated from data obtained from national or subnational cancer registries, while two studies used mortality rates. In most of these studies, the temporal association between trends in use of mobile phones and cancer incidence was assessed informally and descriptively. [The geographical correlation study carried out in several states of the USA ([Lehrer *et al.*, 2011](#)) failed to adequately account for population size and composition.]

Studies that covered a long period between increasing use of mobile phones among the population under investigation and available data on cancer incidence from high-quality cancer registries were most informative for evaluating time trends. In Scandinavia, the rise in use of the mobile phone occurred relatively early. The reported prevalence of mobile-phone use among men aged 40–59 years was 7% in 1989 and reached 28% in 1993 ([Deltour *et al.*, 2010](#)). No change in trends in cancer incidence was observed between 1993 and 2003 for this age group, which had the highest proportion of people who started using mobile phones at an early stage ([Deltour *et al.*, 2009](#)). In the USA, the use of mobile phones started to increase somewhat later; about 100 million subscribers were registered in 2000, i.e. 36% of the population ([Inskip *et al.*, 2010](#)). According to data collected by the Surveillance, Epidemiology, and End Results (SEER) Program, age- and sex-specific trends and overall temporal trends in rates of incidence of brain cancer in the USA were flat or downward between 1992 and 2006, with the exception of women aged 20–29 years ([Inskip *et al.*, 2010](#)). In this age group, a statistically significant increasing trend was driven by the rising incidence in tumours of the frontal lobe. [It is the temporal lobe that is most heavily exposed to radiation when using a mobile phone at the ear ([Cardis *et al.*, 2008](#)).]

Table 2.11 Time trends in use of mobile phones and cancer occurrence

Reference	Location	Exposure data	Trend in exposure	Organ site	Period of cancer occurrence	Cancer data	Cancer trend	Comments
Cook <i>et al.</i> (2003)	New Zealand	Proportion of mobile-phone subscribers in the New Zealand population	Sharp increase from 1987 (1%) to 1998 (> 30%), particularly since 1993 (5%)	All brain and salivary gland; temporal lobe; parietal lobe	1986–98	Incidence rates from New Zealand Cancer Registry	Flat trends from 1986 to 1998	No apparent impact of mobile-phone use on incidence of brain cancer. This study could only detect a risk if it occurred within 4 yr of first exposure
Hardell <i>et al.</i> (2003)	Sweden	None	Presumably sharp increases between 1980s and 2000	Vestibular schwannoma	1960–98	Incidence rates from Swedish Cancer Registry	Increase from 1960 to 1985, then rather flat	No effect of mobile-phone trends. Too early
Lönn <i>et al.</i> (2004)	Denmark, Finland, Norway, Sweden	Proportion of mobile-phone subscribers per year in each country	Sharp increase from 1987 (1–2%) to 1998 (30–50%) particularly after 1993	All brain and subtypes	1969–98	Incidence rates from Nordic National Cancer Registries	Gradual increase from 1968–1983; flat from 1983–96; slight upticks in 1997 and 1998	No apparent impact of mobile-phone use on incidence of brain cancer. Long-standing, high-quality registries. Increased incidence in late 1970s and early 1980s coincides with improvements in diagnosis. This study could only detect a mobile-phone-related risk if it occurred within about 5 yr of first exposure.
Muscat <i>et al.</i> (2006)	USA (SEER Program); 17 registries; about one quarter of the USA population	Unclear	From 0% to about 50% of the population; “exponential increase”	Neuronal tumours	1973–2002	Incidence rates from SEER	No change in incidence between two periods (1973–85 and 1986–2002)	No apparent impact of mobile-phone use on incidence of neuronal tumours. No data on year-by-year variability. Not clear when the number of users increased, probably in the early to mid-1990s. Neuronal tumours are extremely rare.

Table 2.11 (continued)

Reference	Location	Exposure data	Trend in exposure	Organ site	Period of cancer occurrence	Cancer data	Cancer trend	Comments
Nelson <i>et al.</i> (2006)	England and Wales, United Kingdom	Active mobile-phone subscriptions by year, 1987–2004	Very little before 1993; gradual increase to 1997 (10 million) then sharp annual increase to 2004 (60 million)	Acoustic neuroma	1979–2001	Incidence rates from National Cancer Registry for England and Wales	Gradual increase from 1980 to 1990; sharp increase to 1997; decline to 2000. Rise and decline of acoustic neuroma attributed to changes in diagnosis and registration	No apparent impact of mobile-phone use on incidence of acoustic neuroma. The reason for decline in rates after 1997 is uncertain, but its magnitude illustrates the difficulty of detecting a signal if there is one, against the background noise of statistical variability and methodological challenges. The number of subscriptions, approx. 60 million, is clearly in excess of the number of people with subscriptions in England and Wales.

Table 2.11 (continued)

Reference	Location	Exposure data	Trend in exposure	Organ site	Period of cancer occurrence	Cancer data	Cancer trend	Comments
Propp et al. (2006)	Several centres in the USA	None	NR	Acoustic neuroma (vestibular schwannoma)	Los Angeles 1975–98; other centres 1985–99	Incidence rates from the Central Brain Tumor Registry of the USA, and the Los Angeles County Cancer Surveillance Program	Modest, but discernable gradual increases over the period of observation	No apparent impact of mobile-phone use on incidence of acoustic neuroma. Modest increase in risk over the period of time studied (1970s to 1990s) could be due to improvement in diagnosis and registration or to some environmental factor. While the authors present no data on trends in mobile-phone use, it is likely that use increased in the early to mid-1990s. This study could only detect a mobile-phone-related risk if it occurred within about 5 yr of first exposure.
Röösli et al. (2007)	Switzerland	Prevalence of mobile phone use by year, with mortality rates	None before 1987; slow increase to 1996 (< 10%) and then sharp increase to 2000 (> 60%)	All brain (ICD-8 code 191)	1969–2002	Mortality rates from Swiss Federal Statistical Office	Gradual increase from 1969 to 2002, reaching a plateau after 1997. Smaller increase in rates after 1987 than before. For the whole period, there was a significant increase for men and women in older age groups, but not in younger ones. From 1987 onwards, rather stable rates in all age groups.	No apparent impact of mobile-phone use on incidence of cancer of the brain. High-quality mortality data. Authors quantify difficulty in detecting risk in such an ecological study. Improvements in survival may influence trends in mortality.

Table 2.11 (continued)

Reference	Location	Exposure data	Trend in exposure	Organ site	Period of cancer occurrence	Cancer data	Cancer trend	Comments
Deltour <i>et al.</i> (2009)	Denmark, Finland, Norway, Sweden	Unclear	Use increased from zero in the mid-1980s to 'widespread' in the early 1990s to 'sharply increased' in the mid-1990s.	Glioma and meningioma	1974–2003	Incidence rates from Nordic National Cancer Registries	Very slight increases in incidence from 1974 to 1997; no change after 1998	No apparent impact of mobile-phone use on incidence of cancer of the brain. High-quality registration. Up to 10 yr potential latency
Hardell & Carlberg (2009)	Sweden	None	Presumably sharp increases between 1980s and 2000	Brain, age > 19 yr Acoustic neuroma, age > 19 yr	1970–2007	Incidence rates from Swedish Cancer Registry	Changing annual incidence: 1970–79 (+0.15%) 1980–89 (+1.54%) 1990–99 (–0.25%) 2000–07 (+1.26%) 1970–79 (–1.66%) 1980–89 (+4.86%) 1990–99 (+0.66%) 2000–07 (–7.08%)	No evidence of an impact of mobile-phone use on the risk of acoustic neuroma. No or very weak evidence of an effect of phone use on risk of tumours of the brain. Slightly stronger evidence for increased risk of astrocytoma in the most recent period
Inskip <i>et al.</i> (2010)	USA (SEER Program); nine state or regional population-based cancer registries	Number of mobile-phone subscribers in USA by year	From very few in 1990 to 25 million in 1995; 100 million in 2000 and 200 million in 2005	All brain, excluding meningioma and lymphoma	1977–2006	Incidence rates from SEER	Gradual increase in risks from 1977 to 1985; since 1986 the pattern is flat or slightly decreasing. Some age/sex subgroups show increasing trends in some subtypes	No apparent impact of mobile-phone use on incidence of cancer of the brain. Very large numbers of cases. Up to 10 yr of potential latency

Table 2.11 (continued)

Reference	Location	Exposure data	Trend in exposure	Organ site	Period of cancer occurrence	Cancer data	Cancer trend	Comments
Czerninski et al. (2011)	Israel	None	Exposure trend not shown but presumably sharp increase between mid-1980s and 2006	Parotid gland	1970–2006	Incident numbers of cases from Israel National Cancer Registry	Approximate tripling of number of tumours of the parotid gland, with increase starting around 1977 and picking-up around 1990	Authors state that population growth explains part of the increase, but they do not acknowledge the role of ageing of the population. Rates would be more convincing than numbers. While numbers increased greatly after 1998, there were, nevertheless, important increases in numbers of cases before mobile phones could plausibly have caused large numbers of cases.
de Vocht et al. (2011a)	England	Mobile-phone subscriptions	Sharp increase from 0 in 1985 to 10 million in 1997 to > 50 million in 2003	All brain and each of 11 subsites	1998–2007	Incidence rates from United Kingdom Office of National Statistics	Linear regression for each of 24 sex/site categories. No significant trend for all cancers combined. Significant increase in incidence of tumours of temporal lobe and decreases in tumours of parietal lobe	No apparent impact of mobile-phone use on incidence of cancer of the brain, except for a small but unconvincing increase in incidence of tumours of the temporal lobe. Up to 10 yr of potential latency. The number of subscriptions, approx. 50 million in 2003, is clearly in excess of the number of people with subscriptions in England.

Table 2.11 (continued)

Reference	Location	Exposure data	Trend in exposure	Organ site	Period of cancer occurrence	Cancer data	Cancer trend	Comments
Nomura <i>et al.</i> (2011)	Osaka	None	Presumably sharp increases between 1980s and 2000	Intracranial	1975–2004	Incidence rates from Osaka Cancer Registry	Age 0–1 yr, flat; age 20–74 yr, flat until 1999 then slight decline; age 75 yr, sharp increase to 1983 then flat	No increase in incidence rates in recent years. Increasing rates in early years may have been due to diagnostic improvements.
Saika & Katanoda, (2011)	Study involved 11 countries: Japan, Hong Kong Special Administrative Region, Republic of Korea, USA, Australia, the Russian Federation, United Kingdom, Italy, Spain, France, Germany	None	Presumably sharp increases between 1980s and 2000	Brain and CNS	1990–2005	Mortality rates from WHO database	In most of the 22 country/sex data sets, there was a rather flat or declining rate; only in the Russian Federation and Spain was there an increase among females	No apparent increase in mortality from cancer of the brain. Mortality rates may reflect trends in diagnostic standards and in survival.

NR, not reported; SEER, Surveillance, Epidemiology and End Results; yr, year

In another study, trends in rates of newly diagnosed cases of cancer of the brain in England between 1998 and 2007 were examined ([de Vocht *et al.*, 2011a](#)). Overall rates of incidence of cancer of the brain in males or females, or in any specific age group were not increased. However, the incidence of tumours of the temporal lobe increased between 1998 and 2007. In a subsequent letter, the same authors reported separate time trends for the periods 1979–99 and 2000–08. For men, a linear regression of age-adjusted rates showed an overall annual increase in 2000–08 of 3.3% (95% CI, 1.1–5.4), whereas it was 2.0% (95% CI, 1.4–2.6) for 1979–99 ([de Vocht *et al.*, 2011b](#)). [The linear regression used for this analysis was not an appropriate method and therefore the 95% confidence intervals reported may not be reliable.] For women, corresponding annual increases were 2.8% (95% CI, 0.9–4.9) for 2000–08 and 1.4% (95% CI, 0.7–2.2) for 1979–99.

[The Working Group noted that time-trend analyses did not provide any indication that the rapid increase in use of mobile phones had been followed by a parallel increase in incidence rates of cancer of the brain. Increases in rates of brain tumours in the 1970s and 1980s had paralleled the introduction and distribution of new diagnostic tools, namely CT and MRI. The Working Group further noted that these descriptive analyses would be null if an excess in cancer risk from mobile-phone use became manifest only decades after phone use began, or if an increase affected only a small proportion of the cases by location.]

(b) Cohort studies

An early attempt to conduct a cohort study in the USA on cancer and mobile-phone use was halted by legal action; consequently, the study did not provide useful results ([Dreyer *et al.*, 1999](#)). A retrospective cohort study was conducted in Denmark based on the subscriber lists from the two Danish mobile-phone operating companies, including 420 095 individual (i.e. virtually all non-institutional) subscribers from 1982 to

1995. Using unique identifiers, these subscribers were linked to the Danish Cancer Registry from 1982 onwards. The linkage allowed the identification of all cancers occurring in this cohort, and notably cancers of putative target organs. Expected numbers of cases were based on rates in the Danish population. Two papers appeared, one covering cancer outcomes from 1982 to 1996 ([Johansen *et al.*, 2001](#)) and the second covering outcomes from 1982 to 2002 ([Schüz *et al.*, 2006c](#)). In the latter, more recent, analysis, the expected rates were computed with cohort members excluded from the reference population by subtracting the number of cases of cancer and person-years observed in the cohort from the corresponding figures for the total Danish population. Approximately 85% of the cohort members were males.

There were various sources of misclassification, as acknowledged by the authors. Members of the reference population, apart from cohort members, may well have used mobile phones, either with subscriptions that were not in their names (e.g. corporate accounts), or with subscriptions taken out after 1995. Moreover, a member of the cohort may have been the official subscriber to an account, but not the true user. Using information from a separate case-control study, it was estimated that as many as 39% of cohort members may not have been mobile-phone users before 1996 and as many as 16% of the reference population may have been users. Using information from Statistics Denmark, it appeared that the cohort members represented a somewhat more affluent section of the Danish population. While the investigators had no data on individual patterns of use, they had information on the year of the individual's first subscription, and this was used to compute SIRs by time since first use. The median duration of subscription among subscribers was 8 years and the maximum was 21 years.

For the entire cohort there was a slight deficit of total cancers among males (SIR, 0.93; 95% CI,

0.92–0.95), and a slight excess among females (SIR, 1.03; 95% CI, 0.99–1.07). For the main cancer types of interest, the results were similarly close to the null value, with relatively narrow confidence intervals, as shown in [Table 2.12](#). For subtypes of cancer of the brain, most SIRs were close to the null value.

The SIR for glioma was 1.01 (95% CI, 0.89–1.14; 257 cases). The odds ratios for glioma in the two lobes closest to the ear showed conflicting results, with a SIR of 1.21 (95% CI, 0.91–1.58) for the temporal lobe and a SIR of 0.58 (95% CI, 0.36–0.89) for the parietal lobe. The SIR was lower for all other areas of the brain, although confidence intervals were overlapping. [[Cardis *et al.* \(2008\)](#) have reported that it is the temporal lobe of the brain that receives the highest percentage of RF radiation deposition (50%).]

The SIR for meningioma was 0.86 (95% CI, 0.67–1.09) and for acoustic neuroma (nerve sheath tumour) it was 0.73 (95% CI, 0.50–1.03). There was no trend in SIR according to years since first subscription, and the subgroup with > 10 years since first subscription had a low SIR for all tumours of the brain and nervous system (SIR, 0.66; 95% CI, 0.44–0.95). [There were few subscribers who began using a mobile phone \geq 10 years before the end of follow-up, and there was no information on individual levels of mobile-phone use.]

The Danish subscriber cohort study was updated for occurrence of acoustic neuroma (vestibular schwannoma) until 2006 ([Schüz *et al.*, 2011](#)). This update and analysis was restricted to a large subset of subscribers and of the Danish population (2.9 million subscribers and non-subscribers) for which independent information was available on each subject's highest level of education, annual disposable income and marital status. Further to the follow-up with data from the Danish cancer registry, a clinical registry of acoustic neuroma was used to achieve completeness of case ascertainment and obtain additional tumour characteristics, such as laterality, and

spread and size of the acoustic neuroma. In this cohort analysis, having a long-term mobile-phone subscription of \geq 11 years was not related to an increased risk of vestibular schwannoma in men (RR, 0.87; 95% CI, 0.52–1.46; adjusted for sociodemographic factors); and no cases of acoustic neuroma occurred among long-term female subscribers versus 1.6 cases expected. Although 53% of Danes reported that they mainly used their phones on the right side, with 35% preferring the left side and 13% having no preferred side, based on data from the launch of a prospective cohort study described in [Schüz *et al.*, 2011](#)), acoustic neuroma in the subscriber cohort occurred equally on both sides (48% of tumours were on the right side, with no change in this proportion over time). Acoustic neuromas in long-term male subscribers were not larger than those in non-subscribers and short-term subscribers (mean diameter, 14.6 versus 15.9 mm).

(c) Case-control studies

There have been many case-control studies of tumours of the brain in relation to use of mobile phones: a series from one group in Sweden (this study also included cordless phones), an IARC-coordinated series from 13 countries known as INTERPHONE (this study included use of cordless phones among the unexposed group), and several others, including three from the USA, and one each from Finland, France, Greece and Japan. Some studies considered all major types of tumours of the brain, while others considered glioma and meningioma, or glioma only, or acoustic neuroma only. The studies are presented below by major tumour type. Most studies were based on interviews with study subjects or proxies, and involved questions on history of mobile-phone use. Various exposure metrics were used in the different studies, including binary indicators of ever versus never use, metrics of duration of use, frequency of use, and time since start of use. In addition, some analyses

Table 2.12 Cohort study of cancer of the brain and use of mobile phones

Reference, study location and period	Total No. of subjects	Follow-up period	Exposure assessment	Organ site (ICD code)	Exposure categories	No. of cases/deaths	Relative risk (95% CI)	Comments
Schüz <i>et al.</i> (2006c) Denmark, 1982–2002	420 095, 357 553 men, 62 542 women	1982–2002	Subscribers to mobile-phone service	All cancers	Ever subscribed	14 291	0.95 (0.93–0.97)	Update of Johansen <i>et al.</i> (2001) . Median time since first subscription, 8 yr. Expected numbers derived from Danish National Cancer Registry after excluding cohort members from the population. Questionable correspondence between mobile-phone subscriptions and use levels.
					Ever subscribed: men	11 802	0.93 (0.92–0.95)	
					Ever subscribed: women	2 447	1.03 (0.99–1.07)	
				Brain, CNS	Ever subscribed	580	0.97 (NR)	
				Brain, CNS	Ever subscribed: men	491	0.96 (0.87–1.05)	
				Brain, CNS	Ever subscribed: women	89	1.03 (0.82–1.26)	
				Brain, CNS	Latency, < 1 yr since start	51	0.90 (0.67–1.18)	
				Brain, CNS	Latency, 1–4 yr since start	266	1.03 (0.91–1.17)	
				Brain, CNS	Latency, 5–9 yr since start	235	0.96 (0.84–1.09)	
				Brain, CNS	Latency, ≥ 10 yr since start	28	0.66 (0.44–0.95)	
				Glioma (191–191.9)	Ever subscribed	257	1.01 (0.89–1.14)	
				Temporal lobe (191.2)	Ever subscribed	54	1.21 (0.91–1.58)	
				Parietal lobe (191.3)	Ever subscribed	21	0.58 (0.36–0.89)	
Meningioma (192.1)	Ever subscribed	68	0.86 (0.67–1.09)					
Nerve sheath tumours (192.0) ^a	Ever subscribed	32	0.73 (0.50–1.03)					

^a Includes other rare tumours of the nerve sheath
CI, confidence interval; CNS, central nervous system; NR, not reported; yr, year or years

considered modifiers of exposure, such as laterality of mobile-phone use. The latter was based on the premise that if there were a risk related to mobile-phone use, it should manifest itself in a greater proportion of tumours on the side of the head corresponding to the subject's preferred side of phone use. Some studies analysed exposure in relation to the lobe in which the tumour appeared, based on the premise that some lobes absorb more RF radiation than others.

(i) *Glioma*

See [Table 2.13](#)

A case-control study of cancer of the brain was conducted in five academic medical centres in the north-eastern USA during 1994–1998 ([Muscat et al., 2000](#)). Interviews were conducted with the cases ($n = 469$), mainly patients with glioma, and with controls ($n = 422$) selected from the same medical centres. Analysis of reported histories of mobile-phone use, adjusting for sociodemographic factors, study centre, proxy status, and date of interview, yielded a set of odds-ratio estimates that showed no effect, whether by various exposure metrics, anatomical location of the tumour, or histological subtypes. The only exception was an odds ratio of 2.1 (95% CI, 0.9–4.7) for neuroepitheliomatous tumours (14 exposed cases). [The Working Group noted that the highest prevalence of these tumours occurred in the temporal lobe.] The longest duration of use considered was ≥ 4 years. [The numbers of cases were small, exposure levels were low: of the 422 controls, 346 had never used a mobile phone and 22 had used a mobile phone for ≥ 4 years.]

[Inskip et al. \(2001\)](#) conducted a case-control study of tumours of the brain in three centres between 1994 and 1998. A total of 489 cases of glioma were interviewed, as were 799 controls. Compared with non-users, self-reported regular use of mobile phones was not associated with excess risk of glioma (OR, 0.8; 95% CI, 0.6–1.2). Based on very small numbers, there was no indication of excess risk among people with the

heaviest (cumulative use, > 500 hours) or longest (5 years or more) use of mobile phones, or any relationship between reported laterality of use and laterality of the tumours, or any relationship with neuroepitheliomatous tumours (OR, 0.5; 95% CI, 0.1–2.0; eight exposed cases). [Of the 799 controls, 625 had never or rarely used a hand-held mobile phone and only 50 had used a hand-held mobile phone before 1993.]

In a case-control study in Finland, the researchers enrolled cases of tumours of the brain and salivary gland occurring in 1996, as well as a 5 : 1 control series selected from the general population ([Auvinen et al., 2002](#)). There were 198 cases of glioma. Each subject was linked to a list of all subscribers to the two mobile-phone companies operating in Finland, to establish whether the subject had been a subscriber, for how long, and what type of phone he or she was using (analogue/digital). Linkage of records to the census allowed the investigators to ensure that the case and control series were similar in occupational, socioeconomic and urban/rural characteristics. The odds ratio for glioma was 1.5 (95% CI, 1.0–2.4) for those who had ever had a mobile-phone subscription (about 12% of all subjects), and 1.7 (95% CI, 0.9–3.5) for those who had had a subscription for > 2 years ($< 4\%$ of all subjects). When examined separately, the ever-users of analogue phones had an odds ratio for glioma of 2.1 (95% CI, 1.3–3.4) and ever-users of digital phones had an odds ratio of 1.0 (95% CI, 0.5–2.0). [A strength of this study was the linkage of cancer records, population-register records, and mobile-phone subscription records. It was limited by small numbers, inability to assess impact of use of mobile phones for > 2 years, and uncertainty about the correspondence between subscription to a mobile-phone service and individual use of mobile phones.]

Two hospital-based case-control studies ([Gousias et al., 2009](#); [Spinelli et al., 2010](#)), one in Greece and the other in France, examined associations between glioma and malignant tumours

of the brain, respectively, and mobile-phone use. The results are summarized in [Table 2.13](#). Neither study was informative due to small numbers and unclear methods of exposure assessment.

The INTERPHONE study, a multicentre case-control study on use of mobile phones and various types of tumour of the brain, is the largest study on this topic so far. The study was coordinated by IARC and conducted in 16 study centres in 13 countries with a common core protocol (Australia, Canada, Denmark, Finland, France, Germany, Israel, Italy, Japan, New Zealand, Norway, Sweden, and the United Kingdom). A detailed description of the study design, epidemiological methods and study population can be found in [Cardis *et al.* \(2007\)](#). In brief, the source population was generally restricted to major metropolitan areas where mobile phones were first introduced and where most of the population was considered to be unlikely to leave the region for diagnosis and treatment. Residents aged between 30 and 59 years were eligible for the study, but somewhat larger age ranges were applied in some of the centres. The study periods also varied somewhat across centres, ranging from 2 to 4 years between 2000 and 2004. Eligible cases were ascertained rapidly through neurological and neurosurgical facilities in the study regions, and completeness of ascertainment was checked with secondary sources ([Cardis *et al.*, 2007](#)). Cases had a histologically confirmed or unequivocal imaging-based diagnosis of a first primary glioma, meningioma or acoustic neuroma. Three centres also included malignant tumours of the parotid gland, and Japan additionally included pituitary tumours. Population controls were randomly selected from population registries (part of Canada, Denmark, Finland, Germany, Italy, Norway, Sweden), electoral lists (Australia, part of Canada, France, New Zealand), patient lists from general practice (United Kingdom) or by random-digit dialling (part of Canada, France, Japan). Controls were individually (part of Canada, France, Japan,

New Zealand, United Kingdom) or frequency-matched (remaining countries) to cases on year of birth (within categories of 5 years), sex and study region. One control was recruited for each patient with a tumour of the brain, two for each patient with acoustic neuroma, and three for each patient with a tumour of the parotid gland.

All consenting subjects were interviewed face-to-face by trained interviewers by use of a computer-assisted personal interview (CAPI) whenever possible. If participants had died or were too ill to be interviewed, a proxy was interviewed. The questionnaire covered demographic factors, potential confounders and risk factors for the diseases of interest, including detailed questions on use of mobile phones and other wireless-communication devices. A regular mobile-phone user was defined as having used a mobile phone for at least one call per week during 6 months or more.

Since the first publications of national results in 2004 ([Christensen *et al.*, 2004](#); [Lönn *et al.*, 2004](#)), numerous papers have presented results from single countries ([Christensen *et al.*, 2005](#); [Lönn *et al.*, 2005](#); [Schoemaker *et al.*, 2005](#); [Hepworth *et al.*, 2006](#); [Schüz *et al.*, 2006a, b](#); [Takebayashi *et al.*, 2006, 2008](#); [Hours *et al.*, 2007](#); [Klaeboe *et al.*, 2007](#); [Schlehofer *et al.*, 2007](#); [Sadetzki *et al.*, 2008](#); [Hartikka *et al.*, 2009](#)) or pooled results from a subset of the INTERPHONE countries, such as the five north European countries: Denmark, Finland, Norway, Sweden, and the United Kingdom ([Schoemaker *et al.*, 2005](#); [Lahkola *et al.*, 2007, 2008](#)). In addition, various papers have addressed methodological issues such as exposure misclassification and selection bias ([Samkange-Zeeb *et al.*, 2004](#); [Berg *et al.*, 2005](#); [Lahkola *et al.*, 2005](#); [Vrijheid *et al.*, 2006a, b, 2009a, b](#)). The results presented here focus on the pooled results from all countries.

The [INTERPHONE Study Group \(2010\)](#) published the pooled analysis of the INTERPHONE study on the risk of glioma and meningioma in relation to use of mobile phones,

Table 2.13 Case-control studies of glioma and use of mobile phones

Reference, study location and period	Total cases	Total controls	Control source (hospital, population)	Exposure assessment	Organ site (ICD code)	Exposure categories	Exposed cases	Odds ratio (95% CI)	Covariates	Comments
Hardell <i>et al.</i> (1999) Sweden, 1994–96	136	Two controls per case	Population	Self-administered standardized questionnaire	48 glioblastoma, 46 astrocytoma, 19 oligodendroglioma, 3 ependymoma, 16 mixed glioma, and 4 other malignant tumours	Never use of mobile phone Ever use	53	1.0 1.0 (0.6–1.5)	Age, sex, SEI, and year of diagnosis	
Muscat <i>et al.</i> (2000) USA, 1994–98	469	422	In-patients from five USA academic medical centres. Controls from the same hospitals as cases, from daily admission rosters	In-person interviews, history of mobile-phone use	Brain cancer (191.0–191.9)	Ever use Cumulative use (h): 0 > 0 to ≤ 8.7 > 8.7 to ≤ 60 > 60 to ≤ 480 > 480	NR 17 12 19 14	0.7 (0.5–1.1) 1.0 1.0 (0.5–2.0) 0.6 (0.3–1.3) 0.9 (0.5–1.8) 0.7 (0.3–1.4)	Age, education, sex, race, study centre, proxy, year of interview	Analyses showed no associations by year of use. Few subjects with long-term heavy exposure. Response rates were 82% for cases and 90% for controls.
	108	422			Temporal lobe	Ever use	108	0.9 (0.5–1.7)		
	60	422			Parietal lobe	Ever use	60	0.8 (0.3–2.0)		
	354	422			Astrocytic	Ever use	41	0.8 (0.5–1.2)		
	35	422			Neuro-epitheliomatous	Ever use	14	2.1 (0.9–4.7)		

Table 2.13 (continued)

Reference, study location and period	Total cases	Total controls	Control source (hospital, population)	Exposure assessment	Organ site (ICD code)	Exposure categories	Exposed cases	Odds ratio (95% CI)	Covariates	Comments
Inskip et al. (2001) USA, 1994–98	489	799	Patients admitted to the same hospitals for a variety of non-malignant conditions.	Computer-assisted, personal interview in the hospital	Glioma	Cumulative use (h):			Hospital, age, sex, race or ethnic group, proximity of residence to the hospital	There are results for other exposure metrics: average daily use, duration of use, year in which use began. Also results for acoustic neuroma, and for laterality by tumour type.
						Never or rarely used	398	1.0		
						< 13	26	0.8 (0.4–1.4)		
						13–100	26	0.7 (0.4–1.3)		
						> 100	32	0.9 (0.5–1.6)		
						> 500	11	0.5 (0.2–1.3)		
						Regular use	85	0.8 (0.6–1.2)		
Start of use before 1993	23	0.6 (0.3–1.4)								
Auvinen et al. (2002) Finland, 1996	398 (198 glioma)	1990	Population Registry Centre of Finland	Information on subscriptions obtained from the two mobile-network providers operating in Finland in 1996	Glioma (191)	<i>Analogue:</i>			Age, sex	Cases, age 20–69 yr
						Ever	26	2.1 (1.3–3.4)		
						< 1 yr	4	1.6 (0.5–5.1)		
						1–2 yr	11	2.4 (1.2–5.1)		
						> 2 yr	11	2.0 (1.0–4.1)		
						<i>Digital:</i>				
						Ever	10	1.0 (0.5–2.0)		
						< 1 yr	3	0.8 (0.2–2.6)		
						1–2 yr	7	1.4 (0.6–3.4)		
						> 2 yr	0	0		

Table 2.13 (continued)

Reference, study location and period	Total cases	Total controls	Control source (hospital, population)	Exposure assessment	Organ site (ICD code)	Exposure categories	Exposed cases	Odds ratio (95% CI)	Covariates	Comments
Hardell et al. (2002b) Sweden, 1997–2000	588	581	Population	Self-administered standardized questionnaire	415 astrocytomas, 6 medulloblastomas, 54 oligodendrogliomas, 11 ependymomas, 65 other/mixed gliomas, and 37 other malignant tumours of the brain	Never use of mobile/cordless phone		1.0 (reference)	Age, sex, SEI, and year of diagnosis	Ipsilateral use of analogue phone was associated with risk of malignant tumour of the brain (OR, 1.8; 95% CI, 1.2–3.0). Ipsilateral use of digital phone was also associated with risk of malignant tumour of the brain (OR, 1.6; 95% CI, 1.1–2.4).
						Analogue, ever use	79	1.1 (0.8–1.6)		
						Digital, ever use	112	1.1 (0.8–1.5)		
						Digital, > 1–6 yr latency	100	1.1 (0.8–1.4)		
						Digital, > 6 yr latency	12	1.7 (0.7–4.3)		

Table 2.13 (continued)

Reference, study location and period	Total cases	Total controls	Control source (hospital, population)	Exposure assessment	Organ site (ICD code)	Exposure categories	Exposed cases	Odds ratio (95% CI)	Covariates	Comments				
Hardell et al. (2006a,c) Sweden, 2000–03	317	1990	Population	Self-administered standardized questionnaire	248 astrocytomas, and 69 other malignant tumours of the brain	Never use of mobile/cordless phone	63	1.0	Age, sex, SEI, and year of diagnosis					
						Ever use, analogue	68	2.6 (1.5–4.3)		Analogue phone: Ipsilateral use: 3.1 (95% CI, 1.6–6.2); contralateral use: 2.6 (95% CI, 1.3–5.4)				
						Ever use, digital	198	1.9 (1.3–2.7)		Digital phone: Ipsilateral use: 2.6 (95% CI, 1.6–4.1); contralateral use: 1.3 (95% CI, 0.8–2.2)				
						<i>Time since start of use, analogue (yr)</i>								
						> 1–5	0	–						
						> 5–10	20	1.8 (0.9–3.5)						
						> 10	48	3.5 (2.0–6.4)						
						<i>Time since start of use, digital (yr)</i>								
						> 1–5	100	1.6 (1.1–2.4)						
						> 5–10	79	2.2 (1.4–3.4)						
> 10	19	3.6 (1.7–7.5)												

Table 2.13 (continued)

Reference, study location and period	Total cases	Total controls	Control source (hospital, population)	Exposure assessment	Organ site (ICD code)	Exposure categories	Exposed cases	Odds ratio (95% CI)	Covariates	Comments
Hardell et al. (2006b) Sweden, 1997–2003	905	2162	Population	Self-administered standardized questionnaire	539 high-grade astrocytomas, 124 low-grade astrocytomas, 93 oligodendrogliomas, 78 other/mixed gliomas and 71 other malignant tumours of the brain	Never use of mobile/cordless phone		1.0 (reference)	Sex, age, SEI, and year of diagnosis	Pooled analysis of case-control data for living cases ascertained from 1997–2000 and 2000–03. See also further results of analyses of these data in Hardell et al. (2009)
						Ever use, analogue	178	1.5 (1.1–1.9)		
						Ever use, digital	402	1.3 (1.1–1.6)		
						<i>Time since start of use, analogue (yr)</i>				
						> 1–5	39	1.2 (0.8–1.8)		
						> 5–10	57	1.1 (0.8–1.6)		
						> 10	82	2.4 (1.6–3.4)		
						<i>Time since start of use, digital (yr)</i>				
						> 1–5	265	1.2 (1.0–1.5)		
						> 5–10	118	1.7 (1.2–2.2)		
						> 10	19	2.8 (1.4–5.7)		
						<i>Cumulative call time, analogue (h)</i>				
						1–1000	147	1.3 (1.0–1.7)		
						1000–2000	10	3.0 (1.1–7.7)		
						> 2000	21	5.9 (2.5–14)		
<i>Cumulative call time, digital (h)</i>										
1–1000	355	1.3 (1.0–1.6)								
1001–2000	26	1.8 (1.0–3.1)								
> 2000	21	3.7 (1.7–7.7)								

Table 2.13 (continued)

Reference, study location and period	Total cases	Total controls	Control source (hospital, population)	Exposure assessment	Organ site (ICD code)	Exposure categories	Exposed cases	Odds ratio (95% CI)	Covariates	Comments
Hardell et al. (2006b) (cont.)						<i>Ipsilateral use, analogue:</i>				
						All malignant	95	2.1 (1.5–2.9)		
						High-grade astrocytoma	62	2.4 (1.6–3.6)		
						Low-grade astrocytoma	10	1.8 (0.8–4.1)		
						<i>Contralateral use, analogue:</i>				
						All malignant	54	1.1 (0.8–1.6)		
						High-grade astrocytoma	37	1.6 (1.0–2.5)		
						Low-grade astrocytoma	4	0.5 (0.2–1.6)		
						<i>Ipsilateral use, digital:</i>				
						All malignant	195	1.8 (1.4–2.4)		
						High-grade astrocytoma	127	2.3 (1.7–3.1)		
						Low-grade astrocytoma	27	1.9 (1.0–3.5)		
						<i>Contralateral use, digital:</i>				
						All malignant	119	1.0 (0.7–1.3)		
						High-grade astrocytoma	69	1.1 (0.8–1.5)		
Low-grade astrocytoma	16	1.1 (0.5–2.1)								

Table 2.13 (continued)

Reference, study location and period	Total cases	Total controls	Control source (hospital, population)	Exposure assessment	Organ site (ICD code)	Exposure categories	Exposed cases	Odds ratio (95% CI)	Covariates	Comments
Gousias <i>et al.</i> (2009) Greece, 2005–07	41	82	Neuro-surgery patients	In-person interviews, history of mobile phone use	Glioma	Minutes per year of mobile-phone use	NR	1.00 (0.99–1.01)	Age, sex, residence area, smoking, alcohol, head trauma	Not informative because of low power and too finely resolved exposure metric
Hardell <i>et al.</i> (2010) Sweden, 1997–2003	346	343 cancer controls, 276 other controls	Swedish Death Registry	Interviews with relative of decedent	314 gliomas and 32 other malignant tumours of the brain	Never use of mobile/cordless phone		1.0	Sex, age, SEI, and year of diagnosis	Analysis of deceased cases (and controls) only
						Ever use, analogue	61	1.7 (1.1–2.7)		
						Ever use, digital	83	1.4 (1.0–2.1)		
						<i>Cumulative call time, analogue (h)</i>				
						1–1000	41	1.5 (1.0–2.5)		
						1001–2000	5	1.1 (0.3–3.3)		
						> 2000	15	5.1 (1.8–14)		
						<i>Cumulative call time, digital (h)</i>				
1–1000	58	1.2 (0.8–1.8)								
1001–2000	8	2.6 (0.9–8.0)								
> 2000	17	3.4 (1.5–8.1)								

Table 2.13 (continued)

Reference, study location and period	Total cases	Total controls	Control source (hospital, population)	Exposure assessment	Organ site (ICD code)	Exposure categories	Exposed cases	Odds ratio (95% CI)	Covariates	Comments
Spinelli et al. (2010) France, 2005	122	122	In-patients from neurosurgery departments of the same hospitals; unrelated to cancer	In-person interviews	Malignant primary tumours of the brain, 72 glioblastomas	Subscription hours/year	37 8 58 13	1.0 0.9 (0.3–2.4) 1.4 (0.8–2.8) 1.1 (0.4–2.8)	Sex, age	Unclear criteria for recruitment; small numbers
INTERPHONE Study Group (2010) Australia, Canada, Denmark, Finland, France, Germany, Israel, Italy, Japan, New Zealand, Norway, Sweden, United Kingdom, 2000–04	2708	2972	Population (except United Kingdom: GP patients)	Interviewer-administered standardized questionnaire	Glioma (D33.0, D43.0–43.9, C71.0–71.9)	Never regular use of mobile phone Regular use <i>Time since start of use (yr)</i> 1.5 2–4 5–9 ≥ 10 <i>Cumulative call time with no hands-free devices (h)</i> < 5 5–12.9 13–30.9 31–60.9 61–114.9 115–199.9 200–359.9 360–734.9 735–1639.9 ≥ 1 640	1042 1666 156 644 614 252 141 145 189 144 171 160 158 189 159 210	1.0 (ref.) 0.81 (0.70–0.94) 0.62 (0.46–0.81) 0.84 (0.70–1.00) 0.81 (0.60–0.97) 0.98 (0.76–1.26) 0.70 (0.52–0.94) 0.71 (0.53–0.94) 1.05 (0.79–1.38) 0.74 (0.55–0.98) 0.81 (0.61–1.08) 0.73 (0.54–0.98) 0.76 (0.57–1.01) 0.82 (0.62–1.08) 0.71 (0.53–0.96) 1.40 (1.03–1.89)	Sex, age, study centre, ethnicity (in Israel) and education	OR highest in short-term users (start of mobile phone use, 1–4 yr before reference date) (OR, 3.77; 95% CI, 1.25–11.4, based on eight cases)

Table 2.13 (continued)

Reference, study location and period	Total cases	Total controls	Control source (hospital, population)	Exposure assessment	Organ site (ICD code)	Exposure categories	Exposed cases	Odds ratio (95% CI)	Covariates	Comments
Hardell et al. (2011a) Sweden, 1997–2003	1148	2438	Population	Self-administered standardized questionnaire	Glioma	Never use of mobile/cordless phone		1.0	Sex, age, SEI, and year of diagnosis	Pooled analysis of case-control data for living cases ascertained from 1997–2000, and 2000–03, as well as case-control data for deceased cases 1997–2003.
						Ever use (mobile phone)	529	1.3 (1.1–1.6)		
						<i>Time since start of use (yr)</i>				
						> 1–5	250	1.1 (0.9–1.4)		
						> 5–10	156	1.3 (1.0–1.6)		
						> 10	123	2.5 (1.8–3.3)		
						<i>Cumulative call time, mobile phone (h)</i>				
						1–1000	427	1.2 (1.03–1.5)		
						1001–2000	44	1.8 (1.2–2.8)		
						> 2000	58	3.2 (2.0–5.1)		

Table 2.13 (continued)

Reference, study location and period	Total cases	Total controls	Control source (hospital, population)	Exposure assessment	Organ site (ICD code)	Exposure categories	Exposed cases	Odds ratio (95% CI)	Covariates	Comments
Cardis et al. (2011) Australia, Canada, France, Israel, Italy, New Zealand, 2000–04	553	1762	Population	Interviewer-administered standardized questionnaire	Glioma (D33.0, D43.0–43.9, C71.0–71.9)	<i>RF TCSE (J/kg)</i>			Sex, age, study centre, ethnicity (in Israel) and education	Interpretation of OR is most meaningful when compared with the corresponding OR for comparable exposure surrogates of mobile-phone use. When stratified for different time windows of time before diagnosis, the OR tended to increase with increasing TSCE for use ≥ 7 yr in the past. For the highest exposure quintile: OR, 1.91 (95% CI, 1.05–3.47)
						< 76.7	67	0.76 (0.53–1.09)		
						76.7–	68	0.94 (0.66–1.35)		
						284.1–	60	0.80 (0.54–1.18)		
						978.9–	57	0.89 (0.61–1.30)		
						3123.9+	103	1.35 (0.96–1.90)		
						<i>Case-only analyses:</i>				
						Ever regular user	30	1.35 (0.64–2.87)		
						<i>Time since start of use (yr)</i>				
						1–4	12	1.37 (0.59–3.19)		
						5–9	7	0.72 (0.27–1.90)		
						≥ 10	11	2.80 (1.13–6.94)		
						<i>Cumulative call time without hands-free devices (h)</i>				
< 39	6	1.19 (0.40–3.51)								
39–220	4	0.93 (0.27–3.14)								
220–520	5	1.38 (0.42–4.53)								
520–1147	10	2.55 (0.94–6.91)								
> 1147	5	0.99 (0.30–3.27)								

Table 2.13 (continued)

Reference, study location and period	Total cases	Total controls	Control source (hospital, population)	Exposure assessment	Organ site (ICD code)	Exposure categories	Exposed cases	Odds ratio (95% CI)	Covariates	Comments		
Larjavaara <i>et al.</i> (2011) Denmark, Finland, Germany, Italy, Norway, Sweden, south-eastern England, 2000–04	888		Population (except United Kingdom: GP patients)	Interviewer-administered standardized questionnaire	Glioma (D33.0, D43.0–43.9, C71.0–71.9)	Never-regular use of mobile phone	91		Country, sex, age group, and SES	Case–case analysis		
						Regular use	107	0.80 (0.56–1.15)				
						<i>Duration of use (yr)</i>						
						1.5–4	65	0.85 (0.57–1.25)				
						5–9	30	0.71 (0.43–1.18)				
						≥ 10	10	0.85 (0.39–1.86)				
						<i>Cumulative call time (h)</i>						
						0.001–46	33	0.82 (0.51–1.31)				
						47–339	38	0.97 (0.60–1.56)				
						> 339	30	0.58 (0.35–0.96)				
						<i>Laterality of use</i>						
						Ipsilateral	51	0.80 (0.52–1.22)				
						Contralateral	37	0.77 (0.47–1.24)				
						Never regular use of mobile phone	91	1.30 (0.95–1.80)			Within-subject comparison	Case–specular analysis
						Regular use	107	1.19 (0.89–1.59)				
						<i>Duration of use (yr)</i>						
						1.5–4	65	1.15 (0.80–1.66)				
5–9	30	1.04 (0.61–1.76)										
≥ 10	10	2.00 (0.68–5.85)										
<i>Cumulative call time (h)</i>												
0.001–46	33	1.39 (0.81–2.38)										
47–339	38	1.21 (0.74–1.97)										
> 339	30	1.00 (0.59–1.69)										

GP, general practitioner; h, hour; NR, not reported; OR, odds ratio; RF, radiofrequency radiation; SEI, socioeconomic index; SES, socioeconomic status; TCSE, total cumulative specific energy; yr, year

and included 2708 cases of glioma and 2972 controls. The study included 252 cases of glioma and 232 controls who had first used a mobile phone at least 10 years before the reference date. Participation rates were 64% among cases of glioma and 53% among controls. There was wide variation in participation rates for controls between study centres (42–74%).

For regular users, the odds ratio for glioma was 0.81 (95% CI, 0.70–0.94) (Table 2.13). In most study centres, odds ratios of < 1.0 were also seen for all categories of time since start of use and of cumulative number of calls. [The reason for these low odds ratios was not established. While it is plausible that this may in part reflect selection/participation biases, sensitivity analyses carried out by [Vrijheid et al. \(2009a\)](#) indicated that it was unlikely to fully explain these results.] In terms of cumulative call time, all odds ratios were < 1.0 for all deciles of exposure except the highest (10th) decile (> 1640 hours). For this exposure group, the odds ratio for glioma was 1.40 (95% CI, 1.03–1.89). There were 252 cases and 253 controls who reported start of use \geq 10 years before the reference date. The odds ratio for the highest exposure decile of cumulative call time dropped from 1.40 to 1.27 when subjects (both controls and cases) who reported use > 5 hours per day were excluded from the analysis. When mobile-phone use was truncated at 5 hours, the odds ratio was 1.38 (95% CI, 1.02–1.87). [There was reasonable doubt about the credibility of such reports and it is possible that the excess of cases in those with unreasonably high values reflected a general tendency for cases to overestimate more than controls, which could contribute to the apparent excess risk in the highest decile. As noted earlier, there is evidence that cases tended to overestimate their past exposure more than controls ([Vrijheid et al., 2009a](#)).] For cases of glioma, the proportion of proxy respondents, the number of imputations for missing values, and the proportion of subjects judged by their interviewer to be non-responsive or having

poor memory were all higher than for controls ([INTERPHONE Study Group, 2010](#)). However, sensitivity analyses showed that these differences by themselves did not explain the results seen in the highest decile of cumulative call time. More information on the various methodological issues and corresponding sensitivity analyses were discussed by the [INTERPHONE Study Group \(2010\)](#). There was no evidence of heterogeneity in effect across study centres.

More detailed analyses were conducted by the INTERPHONE study team to evaluate the possible association between mobile-phone use and risk of glioma. The odds ratio in the highest exposure decile of cumulative use was larger for tumours in the highly exposed temporal lobe (OR, 1.87; 95% CI, 1.09–3.22) than in the less exposed parietal or frontal lobes (OR, 1.25; 95% CI, 0.81–1.91) or for tumours in other locations (OR, 0.91; 95% CI, 0.33–2.51). This result was consistent with patterns of energy deposition in the brain ([Cardis et al., 2008](#)).

The ratio of the odds ratios for ipsilateral phone use to those for contralateral use increased steadily with increasing cumulative number of calls. [This would be expected if there were an exposure–response association.] However, notwithstanding similar trends in higher exposure categories, the highest ratios of these odds ratios for cumulative call time and for time since start of use were observed in the lowest exposure categories. [While these odds ratios were highly imprecise, this pattern may suggest bias in recall of side of phone use.]

In Appendix 2 of the [INTERPHONE Study Group \(2010\)](#) publication, an additional analysis was reported in which never-regular users were excluded from the analysis and the lowest exposure category was used as the reference category. This analysis was based on the assumption that participation bias was the principal explanation for the decreased odds ratios of the main analysis and that bias was related only to mobile-phone user status and not to extent of use. As a result,

most of the odds ratios for glioma increased above unity. Increased odds ratios were found for people who started to use their phone 2–4 years before diagnosis (OR, 1.7; 95% CI, 1.2–2.4), 5–9 years before diagnosis (OR, 1.5; 95% CI, 1.1–2.2) or > 10 years before diagnosis (OR, 2.2; 95% CI, 1.4–3.3). In terms of cumulative call time, the odds ratio for glioma did not show an upward trend for the first nine deciles of exposure, but the odds ratio for the highest category (> 1640 hours) was increased (OR, 1.8; 95% CI, 1.2–2.9).

Some publications of the results for glioma from national INTERPHONE centres were based on broader eligibility criteria, e.g. extending the age range to 20–70 years ([Christensen et al., 2005](#)). Inclusion of additional cases did not yield markedly different results in these national publications compared with the pooled analysis.

[The strengths of the INTERPHONE study included its large sample size, the common core protocol, comprehensive data collection and in-depth data analyses (including a wide variety of sensitivity and validation analyses), and its use of population-based controls. The exposure assessment was, however, a limitation. As in most other case–control studies, mobile-phone use was estimated from retrospectively collected interview data and thus recall error was an issue. According to a comparison of self-reported mobile-phone use with operator-recorded data in a comparatively small sample of INTERPHONE participants from Australia, Canada and Italy, little differential exposure misclassification between cases and controls was found on average. However, in the highest category of cumulative number of calls, overestimation was more pronounced in cases than in controls ([Vrijheid et al., 2009a](#)). Furthermore, the ratio of self-reported phone use to recorded phone use increased with increasing time before the interview to a greater degree in cases than in controls. Such a pattern could explain an increased risk in the most extreme exposure categories. However, the number of subjects with long-term data was

relatively small and recall could only be assessed for 4–6 years at most.

Another limitation of the INTERPHONE study was the relatively low participation rate, particularly for controls (53%), which was less than that for cases (patients with glioma, 64%; meningioma, 78%; acoustic neuroma, 82%). This offered the potential for differentially selective study participation; and there is evidence that people who had ever used mobile phones regularly were more likely to agree to participate than people who had never used mobile phones regularly ([Lahkola et al., 2005](#); [Vrijheid et al., 2009b](#)). This would produce downwardly biased estimates of relative risk. [The Working Group noted that a strength of this study was its use of population-based controls and the relatively high participation rate of cases.]

In summary, there was no increased risk of glioma associated with having ever been a regular user of mobile phones in the INTERPHONE study. There were suggestions of an increased risk of glioma in the group in the highest decile of exposure, for ipsilateral exposures, and for tumours of the temporal lobe [although chance, bias or confounding may explain this increased risk].

After publication of the pooled data on glioma, additional analyses were undertaken by the INTERPHONE researchers to evaluate the association between mobile-phone use and risk of glioma. They included refined dose estimation, case–case analyses, and case–specular analyses. Each of these analyses has its merits in complementing the overall picture and in evaluating the role of bias, as discussed below.

Refined dose estimation

In principle, a measure of absorbed RF radiation should be a more biologically relevant metric than “use” of mobile phones, if estimated accurately. In an attempt to derive a more biologically relevant metric, data from five INTERPHONE countries (Australia, Canada, France, Israel and

New Zealand) were used to examine the associations of tumours of the brain with RF fields from mobile phones by estimating the total cumulative specific-energy (TCSE) dose for each individual ([Cardis et al., 2011](#)). For each case, the location of the tumour was determined by neuroradiologists and the centre of the tumour was estimated by a computer algorithm (Israel) or by the neuroradiologist (most participants in the other countries). This analogous tumour location was allocated to the controls matched to each case. Matching was done *post hoc* by use of an algorithm that optimized matching on interview time and age within strata defined by sex, region and, in Israel, country of birth. The number of controls per case varied from 1 to 19 (median, 3).

For each study participant, the TCSE was calculated with an algorithm considering the frequency band and communication system of all phones the subject had used, multiplied by call duration. In addition, laterality, use of hands-free devices, network characteristics and urban or rural residence were taken into account (for details, see [Cardis et al., 2011](#)). A census of TCSE was carried out 1 year before the reference date.

For the glioma analysis, the 553 cases of glioma for which localization data and communication-systems information were available (42% of all eligible cases) and their 1762 controls (36% of ascertained controls) were included. Odds ratios for glioma were < 1.0 in the first four quintiles of TCSE. In the highest quintile, the odds ratio for glioma was 1.35 (95% CI, 0.96–1.90). Various sensitivity analyses did not markedly affect this odds ratio. Odds ratios in categories of TCSE were also examined in time windows since first use of a mobile phone. There was a fairly consistent dose–response pattern with an odds ratio of 1.91 (95% CI, 1.05–3.47) in the highest exposure quintile when considering TCSE exposure ≥ 7 years before the reference date. There was little evidence of an association for exposures in more recent time windows. [The Working Group noted that TCSE was highly

correlated with cumulative call time (weighted kappa, 0.68). As this exposure surrogate was mainly determined by self-reported data, recall and selection bias were of concern, as they were for the other INTERPHONE analyses. Results from TCSE analyses were similar to those for cumulative duration of mobile-phone use.]

Case–case analyses

This is a novel approach for studying the effect of radiofrequency fields emitted by mobile phones. As it is based on cases only, differential participation and recall error between cases and controls is not of concern. In both studies presented below, reported preferred side of use was not considered for determining exposed brain areas. While, this should reduce the possible impact of recall bias, it probably also introduces exposure misclassification, which is expected to be random and thus would bias any risk estimates towards unity.

The same database of five countries discussed above ([Cardis et al., 2011](#)) was used to conduct a case–case analysis by comparing the characteristics of mobile-phone use among people with tumours in highly exposed areas of the brain, defined as areas absorbing $> 50\%$ of the specific absorption rate (SAR) from use of mobile phones at both sides of the head (i.e. without taking into account laterality), with the corresponding characteristics of people with tumours in other parts of the brain. Comparisons were made with respect to time since first use of a mobile phone and cumulative call time. The odds ratio for presence of the tumour in the most exposed part of the brain for people who had started using a mobile-phone ≥ 10 years previously was 2.80 (95% CI, 1.13–6.94; based on 11 exposed cases), but it was not increased for people who had started using a mobile-phone more recently. There was, in addition, moderate but inconsistent evidence that the odds ratio for presence of a tumour in the most exposed area increased with increasing cumulative call time.

Data from seven INTERPHONE European countries (Denmark, Finland, Germany, Italy, Norway, Sweden, and south-eastern England) were also used to conduct a case–case analysis ([Larjavaara et al., 2011](#)). In total, 888 cases of glioma in people aged between 18 and 69 years were included. For each case, the tumour midpoint on a three-dimensional grid was defined, based on radiological images. The distance to the estimated axis of a mobile phone in use on the same side of the head as the glioma was calculated, irrespective of the patient’s reported typical side of phone use. Regression models were then computed to compare distance between the midpoint of the glioma and the mobile-phone axis for various exposure groups of self-reported mobile-phone use. In addition, unconditional logistic regression models were applied for the number of tumours occurring at a distance of ≤ 5 cm from the phone axis.

These analyses did not suggest an association between mobile-phone use and distance of glioma from the mobile-phone axis. For instance, the mean distance between tumour midpoint and the phone axis was similar among never-regular mobile-phone users and regular users (6.19 versus 6.29 cm; $P = 0.39$). In the dichotomized analysis examining the occurrence of tumours at a distance of ≤ 5 cm from the phone axis, odds ratios were below unity for the most exposed groups relative to never-regular users. [A limitation of the study was that exposed areas were defined on the basis of distance from the phone axis only; there were no dosimetric calculations. The results of analyses of the spatial distribution of SAR from more than 100 mobile phones ([Cardis et al., 2008](#)) showed that, although there was some variability, most exposure occurs in areas of the brain closest to the ear. Exposure is not evenly distributed along the phone axis; thus the approach used could result in substantial misclassification of exposure.]

Case–specular analysis

In the case–specular analysis, a hypothetical control location is defined in the head of each patient with glioma. This was done for the data from the seven European countries described above ([Larjavaara et al., 2011](#)) by symmetrically reflecting the location of the actual tumour site across the midpoint of the axial and coronal planes to obtain the mirror-image location as the control location. This counterfactual control site and the location of the actual case site were compared with respect to their distances orthogonal to the mobile-phone axis. An association would be indicated if the odds ratio increased systematically with the amount of exposure; however, this pattern was not observed. The odds ratio was larger for never-regular users than regular users. There was no increasing odds ratio for increasing use of cumulative call time.

[The strength of case–specular analysis is that each subject is his/her own control. Nevertheless, the analysis relies on self-reported use of mobile phones when comparing odds ratio between various strata. Thus exposure misclassification affects the analysis. Never-regular users were, on average, older and more commonly female, and if these factors were to affect the tumour location, bias could be introduced. However, there was little indication for this. A limitation of the study was the small number of long-term users in the case-specular analysis, resulting in wide confidence intervals. As noted above, the absence of dosimetric calculations and use of distance to the phone axis rather than to the most exposed part of the brain was a limitation.]

[Hardell et al. \(1999, 2000, 2001, 2002a, b, 2003, 2006a, b, 2009, 2010, 2011a\)](#) have published a series of papers reporting findings regarding associations between use of mobile phones and tumours of the brain. All these epidemiological analyses have been of the case–control design, with cases identified from records of regional cancer registries in Sweden and controls

identified from the Swedish population register or the Swedish death registry (the latter was used when sampling controls for deceased cases). [While reported in a series of publications, the Working Group noted that this research had involved the ongoing collection of case-control data over an extended period of time using a fixed protocol. The Working Group noted that a strength of these analyses followed from the early, and widespread, use of mobile phones in Sweden, implying a population that has accrued exposures from mobile phones over a relatively long time period (analogue phones have been in use since the early 1980s). The fairly long-term exposure from mobile phones permits consideration of any effect that may appear after a more protracted period of exposure than in other locations. Consequently, *Hardell et al.* could address higher cumulative exposures (when measured in terms of total duration of phone use), and include people using devices designed with early mobile-phone technologies, which tended to have higher power output than those based on later mobile-phone technologies.]

In the latest paper available, [Hardell et al. \(2011a\)](#) reported the findings of a pooled analysis of associations between mobile- and cordless-phone use and glioma. Cases were ascertained from 1 January 1997 to 30 June 2000 from population-based cancer registries in Uppsala-Orebro, Stockholm, Linkoping, and Gothenburg, and from 1 July 2000 to 31 December 2003 in Uppsala-Orebro and Linkoping. Eligible cases were aged 20–80 years at diagnosis. Population controls were selected from the Swedish population registry, which includes all residents; controls were matched to cases based on calendar year of diagnosis as well as age (within 5-year categories), sex and study region. Deceased controls for deceased cases were selected from the death registry. Environmental and occupational exposures were assessed by a self-administered 20-page questionnaire sent out by post. The questionnaire solicited information regarding demographic

characteristics, occupational history, and other potential risk factors for cancer of the brain, and asked detailed questions on use of mobile phones and other wireless communication technologies, including year of first use, type of phone, average number of minutes of daily use, and side of head on which the phone had been used most frequently. A maximum of two reminders was sent if the questionnaire was not completed. A trained interviewer, using a structured protocol, carried out supplementary phone interviews to verify information provided in the questionnaire. Questionnaires were assigned an identification code such that the phone interviews and coding of data from questionnaires were blinded to case-control status. Study participants were asked again as to the side of head on which a phone had been used most frequently. [The Working Group noted that bias could be introduced by such an interview process; [Hardell et al. \(2002a\)](#) provided some information regarding classification of cases and controls with respect mobile-phone use based on the questionnaire, and the participants' classification after supplementary interview.] All study participants using mobile or cordless phones were sent an additional letter to re-solicit information on the side of the head on which the phone had been used most frequently. Details regarding the exposure assessment are reported in [Hardell et al. \(2006a, b\)](#). For deceased participants, an interview with a proxy (relative of the deceased) was conducted. Exposure was defined as reported use of a mobile phone and separately reported use of a cordless phone; exposure in the year immediately before case diagnosis or control selection was not included.

Cumulative lifetime use in hours was dichotomized by use of the median number of hours among controls as a cut-off point; and, lifetime use in hours was categorized into the following groups: 1–1000, 1001–2000, and ≥ 2000 hours. Three categories of time since exposure were considered > 1 –5 years, > 5 –10 years, and

> 10 years. Primary statistical analyses were conducted using unconditional and conditional logistic regression models with adjustment for sex, age, socioeconomic index, and year of diagnosis. Participation rates were 85% among cases and 84% among controls.

The analysis included 1148 cases with a histopathological diagnosis of glioma ([Hardell *et al.*, 2011a](#)). When mobile-phone users were compared with people who reported no use of mobile or cordless phones, or exposure > 1 year before the reference date, the odds ratio for glioma was reported to be 1.3 (95% CI, 1.1–1.6) ([Table 2.13](#)). For study participants who first used a mobile phone ≥ 10 years before the reference date, the odds ratio was 2.5 (95% CI, 1.8–3.3). This study included 123 cases of glioma and 106 controls among those who first used a mobile phone ≥ 10 years before the reference date. In terms of cumulative call time using a mobile phone, odds ratios for glioma increased with increasing categories of lifetime exposure. For the highest exposure group (> 2000 hours), the odds ratio was 3.2 (95% CI, 2.0–5.1). Use of cordless phones was also associated with glioma: the odds ratios for 1–1000 hours, 1001–2000 hours and > 2000 hours of use were 1.2 (95% CI, 0.95–1.4), 2.0 (95% CI, 1.4–3.1), and 2.2 (95% CI, 1.4–3.2), respectively. When considering age at first use, the odds ratio for mobile-phone use for all malignant tumours of the brain was 2.9 (95% CI, 1.3–6.0) for ages < 20 years, 1.3 (95% CI, 1.1–1.6) for ages 20–49 years, and 1.2 (95% CI, 1.0–1.5) for ages ≥ 50 years.

[The Working Group noted that information obtained from next of kin may be less reliable than that from living cases and controls. Analyses reported by [Hardell *et al.*](#) that are based solely on information obtained from living cases and controls are not affected by the same concerns about bias arising from information obtained from next of kin.] Excluding deceased cases (and affiliated controls) yielded odds ratios of 1.5 (95% CI, 1.1–1.9) for ever-use of analogue phones, 1.3

(95% CI, 1.1–1.6) for ever-use of digital phones, and 1.3 (95% CI, 1.1–1.6) for ever-use of cordless phones ([Hardell *et al.*, 2006a](#)).

Information on laterality of phone use was collected only from living cases and controls. Pooled case–control analyses were restricted to 905 living cases with malignant tumours of the brain and 2162 controls ([Hardell *et al.*, 2006b](#); [Hardell & Carlberg, 2009](#)). Of the cases, 663 were astrocytomas (grades I–IV), 93 were oligodendrogliomas, and the remainder were other malignant tumours of the brain. Participation rates were 90% among cases with malignant tumours and 89% among controls. For users of analogue and digital mobile phones, an increased odds ratio was seen for all malignant tumours of the brain and high-grade astrocytomas with ipsilateral use of mobile phones and with the tumour on the same side of the head, but no increased risk for contralateral use of mobile phones when compared with people who had not used mobile or cordless phones ([Table 2.13](#)). [The Working Group noted that a strength of this study was its use of population-based controls and the high participation rate of cases and of controls.]

An earlier report by [Hardell *et al.*](#) included a different set of cases of tumours of the brain ascertained during 1994–96 in Uppsala and 1995–96 in Stockholm ([Hardell *et al.*, 1999](#)). Participation rates were 90% among cases and 91% among controls. The analyses included 136 cases of malignant tumours of the brain (including 48 cases of glioblastoma, 46 cases of astrocytoma, and 19 cases of oligodendroglioma), with controls matched on sex, age, and region. Of the 425 controls, 161 reported ever having used a mobile phone and 85 reported having used a mobile phone for > 136 hours. Use of a mobile phone was not associated with an increased risk of malignant tumours of the brain (OR, 1.0; 95% CI, 0.7–1.4). [The Working Group noted that a strength of the study was the high participation rates of cases and controls.]

It is useful to consider variation in effect estimates by calendar period. Among cases ascertained during 1997–2000 there were 588 malignant tumours of the brain, including 415 cases of astrocytoma and 54 cases of oligodendroglioma. Ever-use of analogue phones yielded an odds ratio of 1.13 (95% CI, 0.82–1.57), with the odds ratio for ipsilateral use being 1.85 (95% CI, 1.16–2.96) and the odds ratio for contralateral use being 0.62 (95% CI, 0.35–1.11). Ever-use of digital phones yielded an odds ratio of 1.13 (95% CI, 0.86–1.48), with an odds ratio for ipsilateral use of 1.59 (95% CI, 1.05–2.41) and an odds ratio for contralateral use of 0.86 (95% CI, 0.53–1.39) ([Hardell *et al.*, 2002b](#)).

Among cases ascertained in 2000–2003, there were 359 malignant tumours of the brain, including 248 cases of astrocytoma and 69 other malignant tumours. Ever-use of analogue phones yielded an odds ratio of 2.6 (95% CI, 1.5–4.3), with 3.1 (95% CI, 1.6–6.2) for ipsilateral use and 2.6 (95% CI, 1.3–5.4) for contralateral use; and, ever-use of digital phones yielded an odds ratio of 1.9 (95% CI, 1.3–2.7) with 2.6 (95% CI, 1.6–4.1) for ipsilateral use and 1.3 (95% CI, 0.8–2.2) for contralateral use. Estimates of an association tended to be larger for use beginning > 10 years before diagnosis ([Hardell *et al.*, 2006c](#)).

(ii) Meningioma

See [Table 2.14](#)

In the case–control study of [Inskip *et al.* \(2001\)](#) mentioned above, interviews were conducted with a total of 197 cases of meningioma and 799 controls. Compared with non-users, self-reported regular users of mobile phones did not manifest excess risks of meningioma (OR, 0.8; 95% CI, 0.4–1.3).

The Finnish case–control study mentioned above ([Auvinen *et al.*, 2002](#)) included 129 cases of meningioma. The odds ratio for ever-use was 1.1 (95% CI, 0.5–2.4), with a slightly higher odds ratio for use of analogue phones (OR, 1.5; 95% CI, 0.6–3.5). [This study was limited by the short

time since first use of a mobile phone for most people and by the uncertain mobile-phone use ascertainment from subscription information.]

In the pooled INTERPHONE analysis, 2409 cases of meningioma and 2662 controls were included ([INTERPHONE Study Group, 2010](#)). Participation rates were 78% for cases of meningioma and 53% for controls. For regular users, a reduced odds ratio was seen for cases of meningioma (OR, 0.79; 95% CI, 0.68–0.91) (see [Table 2.14](#)). Odds ratios of < 1.0 were also seen for all categories of time since start of use and for cumulative calls. Study participants who first used a mobile phone at least 10 years before interview did not show an increased risk of meningioma. Regarding cumulative number of calls, the group with highest exposure did not show an increased risk of glioma or meningioma. In terms of cumulative call time, all odds ratios were < 1.0 for all deciles of exposure except the highest (10th) decile of recalled cumulative call time (≥ 1640 hours). For this exposure group, the odds ratio for meningioma was 1.15 (95% CI, 0.81–1.62). Increased risk in the highest exposure decile of cumulative call time was more pronounced in short-term users, who started to use phones 1–4 years before the reference date, than in long-term users (≥ 10 years). Sensitivity analyses had little effect on estimated associations between mobile-phone use and risk of meningioma.

The analysis of TCSE and risk of meningioma in five INTERPHONE countries ([Cardis *et al.*, 2011](#)) was based on 674 cases of meningioma and 1796 controls. In the highest quintile of TCSE, the odds ratio for meningioma was 0.90 (95% CI, 0.66–1.24). An odds ratio of 1.01 (95% CI, 0.75–1.36) was reported for the highest quintile of cumulative call time without hands-free devices. In terms of TCSE exposure ≥ 7 years before the reference date, there was no consistent dose–response pattern, but the odds ratio was elevated in the quintile of highest exposure (OR, 2.01; 95% CI, 1.03–3.93). In case-only analyses, the

Table 2.14 Case-control studies of meningioma and use of mobile phones

Reference, study location and period	Total cases	Total controls	Control source (hospital, population)	Exposure assessment	Organ site (ICD code)	Exposure categories	Exposed cases	Odds ratio (95% CI)	Covariates	Comments
Hardell et al. (1999) Sweden, 1994–96	46	439	Population, matched on sex, age, region, and year of diagnosis	Self-administered standardized questionnaire	Meningioma	Never use of mobile phone	30	1.0		
						Ever use	16	1.0 (0.5–2.3)		
Inskip et al. (2001) Phoenix, Boston, Pittsburgh, 1994–98.	197	799	Patients admitted to the same hospitals for a variety of non-malignant conditions.	Computer-assisted, personal interview in the hospital	Meningioma	Regular use	32	0.8 (0.4–1.3)	Hospital, age, sex, race or ethnic group, proximity of residence to the hospital	There are results for other exposure metrics: average daily use, duration, year use began. Also results for laterality.
						Duration ≥ 5 yr	6	0.9 (0.3–2.7)		
						<i>Cumulative use (h)</i>				
						Never or rarely used	165	1.0		
						< 13	8	0.7 (0.3–1.9)		
						13–100	13	1.1 (0.5–2.4)		
> 100	11	0.7 (0.3–1.7)								
> 500	6	0.7 (0.2–2.4)								
Auvinen et al. (2002) Finland, 1996	398 (129 meningiomas)	1990	Population Registry Centre of Finland	Information on subscriptions obtained from the two mobile-network providers operating in Finland in 1996	Meningioma (225.2)	<i>Analogue</i>			Age, sex	Cases aged 20–69 yr
						Ever	8	1.5 (0.6–3.5)		
						< 1 yr	3	2.3 (0.6–9.2)		
						1–2 yr	3	1.6 (0.4–6.1)		
						> 2 yr	2	1.0 (0.2–4.4)		
						<i>Digital</i>				
						Ever	3	0.7 (0.2–2.6)		

Table 2.14 (continued)

Reference, study location and period	Total cases	Total controls	Control source (hospital, population)	Exposure assessment	Organ site (ICD code)	Exposure categories	Exposed cases	Odds ratio (95% CI)	Covariates	Comments
Hardell et al. (2006a) Sweden, 1997–2003	916	2162	Population.	Self-administered questionnaire	Meningioma	Never used mobile or cordless phone	455	1.0	Age, sex, SEI, year of diagnosis	Ipsilateral use of analogue and digital phones was associated with meningioma (analogue: OR, 1.3; 95% CI, 0.9–2.0; digital: OR, 1.4; 95% CI, 1.0–1.8), contralateral use was not (OR, 1.2; 95% CI, 0.7–1.8; and OR, 1.1; 95% CI, 0.8–1.5, respectively).
						<i>Cumulative use, analogue (h)</i>				
						1–500	99	1.3 (1.0–1.7)		
						501–1000	8	1.1 (0.5–2.6)		
						> 1000	6	1.4 (0.5–3.8)		
						<i>Cumulative use, digital (h)</i>				
						1–500	268	1.1 (0.9–1.3)		
						501–1000	18	1.0 (0.6–1.8)		
						> 1000	9	0.7 (0.3–1.4)		
						<i>Latency, analogue (yr)</i>				
> 1–5	32	1.2 (0.8–1.8)								
> 5–10	47	1.2 (0.8–1.8)								
> 10	34	1.6 (1.0–2.5)								

Table 2.14 (continued)

Reference, study location and period	Total cases	Total controls	Control source (hospital, population)	Exposure assessment	Organ site (ICD code)	Exposure categories	Exposed cases	Odds ratio (95% CI)	Covariates	Comments			
INTERPHONE Study Group (2010) Australia, Canada, Denmark, Finland, France, Germany, Israel, Italy, Japan, New Zealand, Norway, Sweden, United Kingdom, 2000–04	2409	2662	Population (except United Kingdom: GP patients)	Interviewer-administered standardized questionnaire	Meningioma (D32.0, D32.9, D42.0, D42.9, C70.0, C70.9)	Never regular use of mobile phone	1147	1.00	Sex, age, study centre, ethnicity (in Israel), and education				
						Ever use	1262	0.79 (0.68–0.91)					
						<i>Time since start of use (yr)</i>							
						1–1.9	178	0.90 (0.68–1.18)					
						2–4	557	0.77 (0.65–0.92)					
						5–9	417	0.76 (0.63–0.93)					
						≥ 10	110	0.83 (0.61–1.14)					
						<i>Cumulative call time with no hands-free devices (h)</i>							
						< 5	160	0.90 (0.69–1.18)			OR, 4.80 (95% CI, 1.49–15.4) in short-term users (start of mobile-phone use 1–4 yr before reference date) with cumulative call time ≥ 1640 h (based on 22 cases)		
						5–12.9	142	0.82 (0.61–1.10)					
						13–30.9	144	0.69 (0.52–0.91)					
						31–60.9	122	0.69 (0.51–0.94)					
						61–114.9	129	0.75 (0.55–1.00)					
						115–199.9	96	0.69 (0.50–0.96)					
200–359.9	108	0.71 (0.51–0.98)											
360–734.9	123	0.90 (0.66–1.23)											
735–1639.9	108	0.76 (0.54–1.08)											
≥ 1 640	130	1.15 (0.81–1.62)											

Table 2.14 (continued)

Reference, study location and period	Total cases	Total controls	Control source (hospital, population)	Exposure assessment	Organ site (ICD code)	Exposure categories	Exposed cases	Odds ratio (95% CI)	Covariates	Comments		
Cardis <i>et al.</i> (2011) Australia, Canada, France, Israel, Italy, New Zealand, 2000–04	674	1796	Population	Interviewer-administered standardized questionnaire	Meningioma	<i>RF TCSE (J/kg)</i>			Sex, age, study centre, ethnicity (in Israel) and education	Interpretation of OR is most meaningful when compared with the corresponding OR for comparable exposure surrogates of mobile-phone use		
							Never regular user	294			1.0	Subjects with tumour centre estimated by a neuro-radiologist or by means of a computer algorithm
							< 76.7	103			0.90 (0.67–1.21)	
							76.7–284.1-	71 56			0.74 (0.53–1.04) 0.56 (0.39–0.80)	Exposure ≥ 7 yr before reference date:
							978.9–3123.9+	62 88			0.72 (0.51–1.02) 0.90 (0.66 to 1.24)	OR, 2.01 (95% CI, 1.03–3.93), for highest quintile

h, hour; OR, odds ratio; RF, radiofrequency radiation; SEI, socioeconomic index; TCSE, total cumulative specific energy; yr, year

odds ratio for having the centre of the tumour within the most exposed area was 1.34 (95% CI, 0.55–3.25) in those who reported starting to use a mobile phone ≥ 10 years previously.

[Hardell *et al.* \(2006a\)](#) reported the results of a pooled analysis of case–control studies of benign tumours of the brain and use of mobile and cordless phones that included 1254 cases of benign tumours, of which 916 were meningioma; deceased cases (and controls) were not included in this analysis. An odds ratio of 1.3 (95% CI, 0.99–1.7) was reported for meningioma when users of analogue mobile phones were compared with people who reported no use of mobile or cordless phones, or exposure ≤ 1 year before the reference date. The odds ratio was 1.1 (95% CI, 0.9–1.3) for users of digital mobile phones and 1.1 (95% CI, 0.9–1.4) for users of cordless phones. Study participants who first used an analogue, digital, or cordless phone at least 10 years previously showed increased risks of meningioma, although estimates were imprecise (OR, 1.6; 95% CI, 1.0–2.5; OR, 1.3; 95% CI, 0.5–3.2; OR, 1.6; 95% CI, 0.9–2.8, respectively).

(iii) Acoustic neuroma

See [Table 2.15](#)

[Inskip *et al.* \(2001\)](#) included a total of 96 cases with acoustic neuroma and 799 controls. Compared with non-users, self-reported regular users of mobile phones did not manifest excess risks of acoustic neuroma (OR, 1.0; 95% CI, 0.5–1.9).

A case–control study of 90 cases of acoustic neuroma and 86 controls selected from among other patients was conducted in a hospital in New York ([Muscat *et al.*, 2002](#)). Subjects were interviewed regarding use of mobile phones and other factors. Analysis of reported histories of mobile-phone use, adjusting for sociodemographic factors and date of interview, yielded a set of odds-ratio estimates that were close to the null value for cumulative hours of use and years of use. [The Working Group noted that numbers

were small, exposure levels were low, and time since first use was short.]

[Schoemaker *et al.* \(2005\)](#) reported pooled results on acoustic neuroma from a subset of the INTERPHONE countries (the five north European countries: Denmark, Finland, Norway, Sweden, and the United Kingdom). There was no indication of an increased risk of acoustic neuroma associated with mobile-phone use ([Table 2.15](#)). Similar negative findings were reported by the INTERPHONE groups in France ([Hours *et al.*, 2007](#)) and Germany ([Schlehofer *et al.*, 2007](#)), and from a case–control study in Japan ([Takebayashi *et al.*, 2006](#)).

In Japan, [Sato *et al.* \(2011\)](#) identified a series of cases of acoustic neuroma diagnosed between 2000 and 2006 in 22 participating hospitals with neurosurgery departments (32% of hospitals solicited). Of 1589 cases identified, 816 agreed to respond to a self-administered questionnaire, received by post, focusing on history of mobile-phone use and history of pre-diagnosis symptoms. Two case series were constituted consisting of: (a) 180 cases among mobile-phone users whose symptoms had not appeared 1 year before diagnosis; and (b) 150 cases among mobile-phone users whose symptoms had not yet appeared 5 years before diagnosis. In each series, the investigators then compared laterality of the tumour with laterality of mobile-phone use and, using a formula described by [Inskip *et al.* \(2001\)](#), they derived an estimate of relative risk of acoustic neuroma related to various metrics of mobile-phone use. Overall, there was no excess risk of acoustic neuroma among ever-users of mobile phones. However, among some subgroups, namely those with the highest duration of daily calls, there were estimates of high risk ratios in the range of 2.74 (95% CI, 1.18–7.85) to 3.08 (95% CI, 1.47–7.41). This excess appeared to be restricted to a small group of cases who were persistently among the highest users during the past 5 years. The authors considered various alternative explanations for this finding,

Table 2.15 Case-control studies of acoustic neuroma and use of mobile phones

Reference, study location and period	Total cases	Total controls	Control source (hospital, population)	Exposure assessment	Organ site (ICD code)	Exposure categories	Exposed cases	Odds ratio (95% CI)	Covariates	Comments
Inskip <i>et al.</i> (2001) USA, 1994–98	96	799	Patients admitted to the same hospitals for a variety of non-malignant conditions	Computer-assisted personal interview in the hospital	Acoustic neuroma	Regular use Duration ≥ 5 yr	22 5	1.0 (0.5–1.9) 1.9 (0.6–5.9)	Hospital, age, sex, race or ethnic group, proximity of residence to the hospital	Analyses by cumulative use showed no associations. Analyses of laterality of tumour by laterality of phone use showed no associations. Very few subjects with long-term exposure. Response rates were 92% for cases and 86% for controls. In groups with highest duration of daily calls: RR ranged from 2.74 (95% CI, 1.18–7.85) to 3.08 (95% CI, 1.47–7.41)
Muscat <i>et al.</i> (2002) New York City, 1997–99	90	86	In-patients with non-malignant conditions from the same hospitals	Interviews with structured questionnaire	Acoustic neuroma (225.1)	Cumulative use (h): 0 1–60 > 60 Years of use: 0 1–2 3–6	72 9 9 72 7 11	1.0 0.9 (0.3–3.1) 0.7 (0.2–2.6) 1.0 0.5 (0.2–1.3) 1.7 (0.5–5.1)	Age, education, sex, study centre, occupation categories, and date of interview	Also presented as h/mo, with similar results. In mobile-phone users tumour was most often on contralateral side.

Table 2.15 (continued)

Reference, study location and period	Total cases	Total controls	Control source (hospital, population)	Exposure assessment	Organ site (ICD code)	Exposure categories	Exposed cases	Odds ratio (95% CI)	Covariates	Comments
Schoemaker et al. (2005) Denmark, Finland, Norway, Sweden, United Kingdom, 1999–2004	678	3553	Population (except United Kingdom: GP patients)	Interviewer-administered standardized questionnaire	Acoustic neuroma (D33.3)	Never	316	1.0	Educational level and combinations of interview year and interview lag time	Matched for centre, region, 5-yr age group, sex
						Regular use	360	0.9 (0.7–1.1)		
						<i>Time since start of use (yr)</i>				
						1.5–4	174	0.8 (0.7–1.0)		
						5–9	139	0.9 (0.7–1.2)		
						≥ 10	47	1.0 (0.7–1.5)		
						<i>P for trend</i>		0.9		
						<i>Cumulative use (h)</i>				
						< 116	168	0.9 (0.7–1.1)		
						116–534	89	0.9 (0.7–1.2)		
						> 534	94	0.9 (0.7–1.2)		
<i>P for trend</i>		0.5								
Takebayashi et al. (2006) Japan, 2000–04	101	339	Population (random-digit dialling)	Interviewer-administered standardized questionnaire	Acoustic neuroma (D33.3)	Never	46	1.0	Education, marital status	Matched for age, sex, residency
						Regular use	51	0.73 (0.43–1.23)		
						<i>Time since start of use (yr)</i>				
						< 4	26	0.70 (0.39–1.27)		
						4–7	21	0.76 (0.38–1.53)		
						≥ 8	4	0.79 (0.24–2.65)		
						<i>P for trend</i>		0.70		
						<i>Cumulative use (h)</i>				
						< 300	35	0.67 (0.38–1.17)		
						300–900	9	1.37 (0.54–3.50)		
						> 900	7	0.67 (0.25–1.83)		
<i>P for trend</i>		0.69								

Table 2.15 (continued)

Reference, study location and period	Total cases	Total controls	Control source (hospital, population)	Exposure assessment	Organ site (ICD code)	Exposure categories	Exposed cases	Odds ratio (95% CI)	Covariates	Comments	
Ha et al. (2007) France, 2001–03	109	214	Population (electoral rolls)	Interviewer-administered standardized questionnaire	Acoustic neuroma (D33.3)	Never regular use of mobile phone	51	1.0	SES, tobacco consumption, noise exposure	Sex, age (\pm 5 yr), place of residence	
						Regular use	58	0.92 (0.53–1.59)			
						<i>Duration of use (mo)</i>					
						< 16	19	1.21 (0.55–2.69)			
						16–27	17	1.33 (0.58–3.03)			
						27–46	8	0.63 (0.26–1.53)			
						> 46	14	0.66 (0.28–1.57)			OR per 1 year, 0.96 (0.84–1.10)
						<i>Cumulative use (h)</i>					
						< 20	14	1.06 (0.48–2.36)			
						20–80	15	0.87 (0.40–1.91)			
80–260	13	0.85 (0.38–1.88)									
> 260	16	0.92 (0.41–2.07)	OR per 80 h, 1.0 (0.96–1.03)								
Schlehofer et al. (2007) Germany, 1976–88	97	194	Population	Interviewer-administered standardized questionnaire	Acoustic neuroma (D33.3)	Never regular use of mobile phone	68	1.0	SES, urbanity	Matched for centre, age, sex	
						Regular use	29	0.67 (0.38–1.19)			
						<i>Time since start of use (yr)</i>					
						1–4	20	0.78 (0.40–1.50)			
						5–9	8	0.53 (0.22–1.27)			
						\geq 10	0	-			
						<i>Cumulative use (h)</i>					
						< 44	16	1.04 (0.51–2.16)			
						44–195	7	0.58 (0.22–1.48)			
						> 195	5	0.35 (0.12–1.01)			

Table 2.15 (continued)

Reference, study location and period	Total cases	Total controls	Control source (hospital, population)	Exposure assessment	Organ site (ICD code)	Exposure categories	Exposed cases	Odds ratio (95% CI)	Covariates	Comments
Sato <i>et al.</i> (2011) Japan, 2000–06	787	787 (case–case)	Note: the affected ear is the case side; the opposite ear is regarded as the control.	Mailed questionnaire about history of mobile-phone use	Acoustic neuroma	Overall, for regular mobile-phone use until one yr before diagnosis	180	1.08 (0.93–1.28)	Same patients	The authors interpret these significant results with caution, mentioning detection and recall bias as possibilities.
						Overall, for regular mobile-phone use until 5 yr before diagnosis	150	1.14 (0.96–1.40)		
						Weighted daily average call duration > 20 min, 1 yr before diagnosis	23	2.74 (1.18–7.85)		
						Weighted daily average call duration > 20 min, 5 yr before diagnosis	33	3.08 (1.47–7.41)		

Table 2.15 (continued)

Reference, study location and period	Total cases	Total controls	Control source (hospital, population)	Exposure assessment	Organ site (ICD code)	Exposure categories	Exposed cases	Odds ratio (95% CI)	Covariates	Comments
INTERPHONE Study Group (2011) Australia, Canada, Denmark, Finland, France, Germany, Israel, Italy, Japan, New Zealand, Norway, Sweden, United Kingdom, 2000–04	1105	2145	Population (except United Kingdom: GP patients)	Interviewer-administered standardized questionnaire	Schwannoma of the acoustic nerve (ICD-9 code 225.1 or ICD-10 code D33.3, and ICD-O topography code C72.4 and morphology code 9560/0)	Never regular use of mobile phone	801	1.00	Sex, age, study centre, ethnicity (in Israel), and education	Data are given only for exposure up to 5 yr before reference date (risk estimates were generally smaller when exposure up to 1 yr before reference date was considered)
						Regular use	304	0.95 (0.77–1.17)		
						<i>Time since start of use (yr)</i>				
						5–9	236	0.99 (0.78–1.24)		
						≥ 10	68	0.83 (0.58–1.19)		
						<i>Cumulative call time (h) with no hands-free devices</i>				
						< 5	42	1.07 (0.69–1.68)		
						5–12.9	30	1.06 (0.60–1.87)		
						13–30.9	40	1.32 (0.80–2.19)		
						31–60.9	36	0.86 (0.52–1.41)		
						61–114.9	21	0.63 (0.35–1.13)		
115–199.9	22	0.71 (0.39–1.29)								
200–359.9	49	0.83 (0.48–1.46)								
360–734.9	26	0.74 (0.42–1.28)								
735–1639.9	22	0.60 (0.34–1.06)								
≥ 1640	32	2.79 (1.51–5.16)								
									When stratifying for duration of use, OR was highest in long-term users (start of mobile-phone use ≥ 10 yr ago): OR, 1.93 (95% CI, 1.10–3.38). Ipsilateral use: OR, 3.74 (95% CI, 1.58–8.83); contralateral use: OR, 0.48 (95% CI, 0.12–1.94)	

Table 2.15 (continued)

Reference, study location and period	Total cases	Total controls	Control source (hospital, population)	Exposure assessment	Organ site (ICD code)	Exposure categories	Exposed cases	Odds ratio (95% CI)	Covariates	Comments	
Hardell et al. (2006a) Sweden, 2000–03	243		Population	Self-administered standardized questionnaire	Acoustic neuroma	Never use of mobile or cordless phone	88	1.0	Age, sex, SEI, and year of diagnosis		
						Ever use of analogue phone	68	2.9 (2.0–4.3)			
						Ever use of digital phone	105	1.5 (1.1–2.1)			
						Ever use of cordless phone	96	1.5 (1.0–2.0)			
						<i>Cumulative call time, analogue (h)</i>					
						1–500	55	2.8 (1.8–4.2)			
						501–1000	7	3.3 (1.3–8.0)			
						> 1000	6	5.1 (1.9–14)			
						<i>Cumulative call time, digital (h)</i>					
						1–500	83	1.4 (1.0–2.0)			Users of analogue phone (> 10 yr) showed OR, 3.1 (95% CI, 1.7–5.7)
						501–1000	10	1.8 (0.8–3.8)			
						> 1000	12	3.1 (1.5–6.4)			
						<i>Cumulative call time, cordless (h)</i>					
						1–500	60	1.3 (0.9–1.9)			
501–1000	15	1.6 (0.9–3.0)									
> 1000	21	2.1 (1.2–3.7)									

GP, general practitioner; h, hour; min, minute; mo, month; OR, odds ratio; SEI, socioeconomic index; SES, socioeconomic status; yr, year

including selection bias and recall bias, and they concluded that it was unclear whether the finding was a consequence of bias.

The pooled INTERPHONE analysis for acoustic neuroma ([INTERPHONE Study Group, 2011](#)) followed in general the same methodology as the analyses for glioma and meningioma described above ([INTERPHONE Study Group, 2010](#)). Patients diagnosed with a schwannoma of the acoustic nerve in the study regions during study periods of 2–4 years between 2000 and 2004 were included in the study. For each case, two age-, sex- and study-region-matched controls were recruited. Controls were either specifically sampled for the cases of acoustic neuroma, taken from the pool of INTERPHONE controls drawn for all tumours together, or obtained with a combination of both approaches. In total, 1105 cases (participation rate, 82%) were included in the analyses, together with 2145 controls (participation rate, 53%). The odds ratio for regular use was 0.85 (95% CI, 0.69–1.04) when recording exposure at 1 year before the reference date and 0.95 (95% CI, 0.77–1.17) when recording exposure at 5 years before the reference date. For cumulative call time, the highest odds ratios were observed in the highest category of use: the odds ratios for ≥ 1640 hours were 1.32 (95% CI, 0.88–1.97) when recording exposure at 1 year and 2.79 (95% CI, 1.51–5.16) when recording exposure at 5 years. There was, however, no consistent trend in the exposure–response relationship in the first nine deciles of exposure. Stratifying the analyses according to time since start of mobile-phone use resulted in an increased odds ratio for heavy users of mobile phones only in long-term users (OR, 1.93; 95% CI, 1.10–3.38, based on 37 cases). This risk estimate was more pronounced with respect to ipsilateral use (OR, 3.74; 95% CI, 1.58–8.83, based on 28 cases) and decreased with respect to contralateral use (OR, 0.48; 95% CI, 0.12–1.94, based on 4 cases). Exclusion of participants with an implausible amount of use (> 5 hours per day) resulted in a decrease in odds ratio for exposure

up to 1 year before the reference date, but had little impact on the results of the analyses of exposure up to 5 years before the reference date. The results for cumulative number of calls were broadly similar, but risk estimates were smaller.

Overall, these results were broadly similar to the results for glioma from the INTERPHONE study. [The same methodological limitations were of concern, mainly selection and recall bias. Diagnostic bias was also of concern: patients with acoustic neuroma who use mobile phones may be diagnosed earlier than non-users, since acoustic neuroma affects hearing capability. However, such an effect would be expected to be most relevant for recent users, but of little relevance for exposure 5 years before diagnosis. On the other hand, prodromal symptoms might discourage cases from becoming mobile-phone users. Again, such an effect would be most relevant in the analysis of most recent use of mobile phones, but not in the analysis of exposure at earlier dates. There is also uncertainty as to how early symptoms may affect the preferred side of use. Regarding confounding, socioeconomic status, ionizing radiation and loud noise were considered, with little effect on the results.]

[Hardell *et al.* \(2006a\)](#) reported the results of a pooled analysis of associations between use of mobile and cordless phones and risk of benign tumours of the brain that included 243 cases of acoustic neuroma. An increased odds ratio was reported for acoustic neuroma (OR, 2.9; 95% CI, 2.0–4.3) when users of analogue mobile phones were compared with people who reported no use of mobile or cordless phones, or exposure ≤ 1 year before the reference date. The odds ratio was 1.5 (95% CI, 1.1–2.1) for users of digital mobile phones and 1.5 (95% CI, 1.04–2.0) for users of cordless phones. Study participants who first used an analogue phone at least 10 years before the reference date showed increased risks (OR, 3.1; 95% CI, 1.7–5.7), but users of digital or cordless phones did not. For users of analogue mobile phones, an increased odds ratio was

seen for ipsilateral use (OR, 3.0; 95% CI, 1.9–5.0) and contralateral use (OR, 2.4; 95% CI, 1.4–4.2) when compared with people who had not used mobile or cordless phones. For users of digital mobile phones, an increased odds ratio was seen for acoustic neuroma with ipsilateral use (OR, 1.7; 95% CI, 1.1–2.6), but not for contralateral use (OR, 1.3; 95% CI, 0.8–2.0) when compared with people who had not used mobile or cordless phones. Similar associations were found for use of cordless phones (ipsilateral use: OR, 1.7; 95% CI, 1.1–2.6; and contralateral use: OR, 1.1; 95% CI, 0.7–1.7, respectively) ([Schüz et al., 2006c](#)).

(iv) *All cancers of the brain combined*

See [Table 2.16](#)

In several studies already referred to above, analyses were presented for all cancers of the brain combined ([Hardell et al., 2000, 2001, 2011a; Inskip et al., 2001; Auvinen et al., 2002](#)). Only in [Hardell et al. \(2011a\)](#) were risks of cancer significantly elevated with prolonged use of mobile phones. A study in France by [Spinelli et al. \(2010\)](#) found no significant excess risks.

(v) *Other cancers of the brain*

A pooled analysis by [Hardell et al. \(2011a\)](#) included 103 cases with a histopathological diagnosis of malignant tumour of the brain other than glioma. Odds ratios for malignant tumours other than glioma by category of duration of mobile-phone use were 1.0 (95% CI, 0.6–1.6) for 1–1000 hours, 1.4 (95% CI, 0.4–4.8) for 1001–2000 hours, and 1.2 (95% CI, 0.3–4.4) for > 2000 hours.

(vi) *Pituitary tumours*

See [Table 2.17](#)

In a Japanese study, 102 cases of pituitary adenoma were included, together with 161 individually matched controls ([Takebayashi et al., 2008](#)). Neither regular use of mobile phones (OR, 0.90; 95% CI, 0.50–1.61) nor cumulative duration of use in years and cumulative call time in hours was associated with an increased risk of pituitary tumours.

In a population-based case–control study from south-eastern England, 291 cases of pituitary tumour diagnosed between 2001 and 2005 were included, together with 630 controls that were frequency-matched for sex, age, and health-authority of residence ([Schoemaker & Swerdlow, 2009](#)). The participation rate was 63% for cases and 43% for controls. Data were collected with a face-to-face interview at the subject’s home or another convenient place. Regular use was not associated with an increased risk (OR, 0.9; 95% CI, 0.7–1.3) nor was any other exposure surrogate. Stratified analyses for analogue or digital mobile-phone user did not indicate consistent exposure–response associations.

(d) *Some reviews, meta-analyses, and other studies*

Various meta-analyses and other comparisons of the accumulating data on mobile-phone use and tumours of the brain have been published ([Hardell et al., 2003, 2007a, 2008; Lahkola et al., 2006; Kan et al., 2008; Ahlbom et al., 2009; Hardell & Carlberg, 2009; Khurana et al., 2009; Myung et al., 2009](#)). Such analyses are potentially useful for characterizing the accumulating evidence and for exploring heterogeneity of findings among studies, along with determinants of any observed heterogeneity. [The Working Group based its conclusions on review of the primary studies.]

2.3.2 *Leukaemia and lymphoma*

(a) *Leukaemia*

There have been four epidemiological studies on leukaemia and use of mobile phones.

In an early cohort study of 285 561 users of analogue phones, identified based on records from two mobile-phone providers in the USA in 1993, mortality attributable to leukaemia was not elevated among users of hand-held phones relative to users of non-hand-held phones (mostly car phones) ([Dreyer et al., 1999; Table 2.18](#)). [A

Table 2.16 Case-control studies of all cancers of the brain and use of mobile phones

Reference, study location and period	Total cases	Total controls	Control source (hospital, population)	Exposure assessment	Organ site (ICD code)	Exposure categories	Exposed cases	Odds ratio (95% CI)	Covariates	Comments
Hardell et al. (2000, 2001) Uppsala-Orebro region and Stockholm region, Sweden, 1994-96	209 cases of brain tumours diagnosed 1994-96 among people aged 20-80 yr at diagnosis	425	Population register. 1:2 case:control ratio with matching on age and sex, and drawn from the same geographical areas as the cases	Self-administered structured, mailed questionnaire	All malignant tumours of the brain. Benign tumours of the brain included from Stockholm in 1996, as part of feasibility study. Histopathology reports on 197 patients, 136 with malignant and 62 with benign tumours.	No use of mobile or cordless phone, or exposure ≤ 1 yr before reference date Mobile-phone use	78	1 0.98 (0.69-1.41)	Sex, age (as a continuous variable). Radiotherapy, diagnostic X-ray, asbestos, solvents, smoking	Participation rate was 90% for cases and 91% for controls. Increased risk for tumour in the temporal or occipital lobe on same side as cell-phone use (OR, 2.62; 95% CI, 1.02-6.71). Contralateral use did not increase the risk (OR, 0.97; 95% CI, 0.36-2.59). Deceased cases were not included. This analysis encompassed the case-control data included in Hardell et al. (2000)
Inskip et al. (2001) USA, 1994-98	782	799	Patients admitted to the same hospitals for a variety of non-malignant conditions.	Computer-assisted in person interview in the hospital, history of mobile-phone use	All brain	No use Regular use Duration ≥ 5 yr	471 139 22	1.0 0.8 (0.6-1.1) 0.9 (0.5-1.6)	Hospital, age, sex, race or ethnic group, proximity of residence to the hospital	Analyses by cumulative use showed no associations. Very few subjects with long-term exposure. Response rates 92% for cases and 86% for controls.

Table 2.16 (continued)

Reference, study location and period	Total cases	Total controls	Control source (hospital, population)	Exposure assessment	Organ site (ICD code)	Exposure categories	Exposed cases	Odds ratio (95% CI)	Covariates	Comments
Auvinen et al. (2002) Finland, 1996	398	1990	Population Registry Centre of Finland	Information on subscriptions obtained from the two mobile-network providers operating in Finland in 1996	All brain (191 and 225.2)	<i>Analogue</i>			Age, sex	Cases aged 20–69 yr
						Ever	40	1.6 (1.1–2.3)		
						< 1 yr	8	1.6 (0.7–3.6)		
						1–2 yr	15	1.5 (0.9–2.8)		
						> 2 yr	17	1.6 (0.9–2.8)		
						<i>Digital</i>				
						Ever	16	0.9 (0.5–1.5)		
						< 1 yr	4	0.6 (0.2–1.6)		
1–2 yr	11	1.2 (0.6–2.3)								
> 2 yr	1	0.6 (0.1–4.5)								
Spinelli et al. (2010) France, 2005	122	122	In-patients from neurosurgery departments of the same hospitals; unrelated to cancer	Face-to-face interviews with standardized questionnaire; and self-administered questionnaire	Malignant primary tumours of the brain	<i>Global cellular-phone use (hours-year)</i>			Age, sex	
						0	37	1		
						≤ 4	8	0.86 (0.30–2.44)		
						4–36	58	1.45 (0.75–2.80)		
						≥ 36	13	1.07 (0.41–2.82)		

Table 2.16 (continued)

Reference, study location and period	Total cases	Total controls	Control source (hospital, population)	Exposure assessment	Organ site (ICD code)	Exposure categories	Exposed cases	Odds ratio (95% CI)	Covariates	Comments		
Hardell et al. (2011a)	1251 cases of malignant brain tumours diagnosed during 1997–2003 among people aged 20–80 yr at diagnosis	2438 controls	Population register. 1:1 case:control ratio with matching on age and sex, and drawn from the same region as the cases. For deceased cases, controls drawn from death registry. 1:1 matching on year of death, sex, age, and medical region	Self-administered structured, mailed questionnaire. For deceased cases and controls, mailed questionnaire was completed by relative of decedent.	All malignant tumours of the brain	No use of mobile or cordless phone, or exposure ≤ 1 yr before reference date	677	1.00	Sex, age (as a continuous variable), SEI code, year of diagnosis	Participation rates were 85% for cases and 84% for controls. This analysis encompassed the data presented in earlier papers on pooled case–control studies of malignant tumours of the brain among living cases diagnosed in 1997–2003		
						Ever	574	1.3 (1.1–1.5)				
						1–1000 h	466	1.2 (1.0–1.4)				
						1001–2000 h	47	1.8 (1.1–2.7)				
						> 2000 h	61	3.0 (1.9–4.8)				
						Malignant tumours of the brain other than glioma (<i>n</i> = 103)	Mobile-phone use:					
						1–1000 h	39	1.0 (0.6–1.6)				
1001–2000 h	3	1.4 (0.4–4.8)										
> 2000 h	3	1.2 (0.3–4.4)										

h, hour or hours; SEI, socioeconomic index; yr, year

Table 2.17 Case–control studies of cancers of the pituitary and use of mobile phones

Reference, study location and period	Total cases	Total controls	Control source (hospital, population)	Exposure assessment	Organ site (ICD code)	Exposure categories	Exposed cases	Odds ratio (95% CI)	Covariates	Comments
Takebayashi et al. (2008) Japan, 2000–04	101	161	Population (random-digit dialling)	Interviewer-administered standardized questionnaire	Pituitary adenoma (ICD code not reported)	Never regular use of mobile phone	39	1.0	Education, marital status	Matched for age (5 yr), sex, residency
						Regular use	62	0.90 (0.50–1.61)		
						<i>Time since start of use (yr)</i>				
						< 2.2	14	0.86 (0.39–1.88)		
						2.2–4.69	13	0.75 (0.31–1.81)		
						4.7–6.5	22	1.64 (0.74–3.66)		
						> 6.5	13	0.75 (0.31–1.82)		
						<i>P for trend</i>		0.89		
						<i>Cumulative use (h)</i>				
						< 39	15	1.00 (0.46–2.16)		
						39–190	14	0.97 (0.40–2.32)		
						190–560	12	0.72 (0.31–1.70)		
						> 560	21	1.33 (0.58–3.09)		
Schoemaker & Swerdlow (2009) United Kingdom, 2001–05	291	630	Population (from GP patient list)	Interviewer-administered standardized questionnaire	Pituitary tumour (C75.1, D35.2, D44.3)	Never regular use of mobile phone	116	1.0	Age, sex, category, geographic area, reference date, and Townsend deprivation score	
						Regular use	175	0.9 (0.7–1.3)		
						<i>Time since start of use (yr)</i>				
						1.5–4	89	1.0 (0.7–1.5)		
						5–9	62	0.8 (0.5–1.2)		
						10–17	24	1.0 (0.5–1.9)		
						<i>P for trend</i>		0.7		
						<i>Cumulative use (h)</i>				
						< 113	79	0.9 (0.6–1.3)		
						113–596	44	1.1 (0.7–1.8)		
						> 596	51	1.1 (0.7–1.7)		
						<i>P for trend</i>		0.9		

GP, general practitioner; h, hour or hours; yr, year

limitation of this study was that there were only four deaths due to leukaemia among users of hand-held phones, as the study was truncated – with no access to mortality data beyond 1 year – as a result of a legal proceeding.]

A study of cancer incidence in a cohort of 420 095 users of mobile phones in Denmark found no evidence of an elevated risk of leukaemia in males or females (SIR, 1.05; 95% CI, 0.96–1.15) (Schüz *et al.*, 2006c; Table 2.18). The incidence of leukaemia was not increased in any of the reported time intervals since first subscription. Details concerning the design of the study were discussed above (Section 2.3.1). [The results for leukaemia were not reported separately by subtype.]

A hospital-based case–control study of adult-onset leukaemia in Thailand conducted between 1997 and 2003 (180 cases, 756 hospital controls) reported an odds ratio for all leukaemias combined of 1.5 (95% CI, 1.0–2.4) (Kaufman *et al.*, 2009; Table 2.19). Overall, the duration of mobile-phone use was short (median, 24–26 months). The results were similar for acute myeloid leukaemia, chronic myeloid leukaemia and chronic lymphocytic leukaemia. There were no trends in associations of all leukaemias with duration of ownership, lifetime hours of use, or amount of use per year. The odds ratio was highest for persons reporting exclusive use of GSM (Global System for Mobile Communications) services. Using an categorization ad hoc into “high risk” and “low risk” groups of mobile-phone users based on phone characteristics, the authors reported an odds ratio of 1.8 for high-risk versus low-risk users (95% CI, 1.1–3.2). [It was unclear to the Working Group as to how the “high risk” and “low risk” groups were derived and whether it was done *a priori* or *a posteriori*.]

In a study conducted in the United Kingdom between 2003 and 2009, which included 806 cases and 585 controls who were non-blood relatives, regular use of a mobile phone (defined as at least one call per week for at least 6 months) was

not associated with the incidence of leukaemia (Cooke *et al.*, 2010; Table 2.19). Risk was not significantly associated with years since first use, lifetime years of use, cumulative number of calls, or cumulative hours of use. Among people who reported using a phone for ≥ 15 years since first use, the odds ratio was 1.87 (95% CI, 0.96–3.63; 50 exposed cases); however, there was no apparent trend with years since first use. There also was no apparent trend in risk with cumulative hours of use. Findings were similar for digital and analogue phones. There was no apparent variation in results by subtype of leukaemia and no trend in risk with years since first use, years of use, or cumulative hours of use for any subtype. [Only 50% of potential cases participated, with the usual reasons for non-participation being death or disability related to leukaemia.]

(b) Lymphoma

In a population-based case–control study conducted in Sweden between 1999 and 2002 (910 cases, 1016 controls), neither mobile-phone use nor cordless-phone use was significantly associated with risk of NHL overall, nor for the B-cell subtype in particular (90% of the cases) (Hardell *et al.*, 2005; Table 2.19). High odds ratios were reported for some categories of use of cordless phones for T-cell lymphomas, based on very small numbers. Cases in this study were diagnosed between the ages of 18 and 74 years. Males and females were included, but the main results concerning mobile-phone use were presented for both sexes combined.

A population-based case–control study of NHL conducted in the USA between 1998 and 2000 (551 cases, 462 controls) also reported predominantly null findings (Linnet *et al.*, 2006; Table 2.19). Several exposure metrics of mobile-phone use were presented (latency, duration, amount of exposure), but overall there was no consistent trend in risk. Risk of NHL was not associated with minutes per week of use of mobile telephones, duration of use, cumulative

Table 2.18 Cohort studies of leukaemia, lymphoma, and other cancers, and use of mobile phones

Reference, study location and period	Total No. of subjects	Follow-up period	Exposure assessment	Organ site (ICD code)	Exposure categories	No. of cases/deaths	Relative risk (95% CI)	Covariates	Comments
Dreyer et al. (1999) USA, 1993	285 561	1993	Records of mobile-phone service providers	Leukaemia (204–207)	<i>Hand-held phones</i> < 2 min/d ≥ 2 min/d	2 2	<i>SMR</i> 1.6 4.9	Age, sex, metropolitan area	Mortality study; effect estimate = SMR; SMR for non-hand-held phones (non-exposed), 7.0
Schüz et al. (2006c) Denmark, 1982–2002	420 095	1982–2002	Records of mobile-phone service providers	Leukaemia (204–207)	<i>Latency (yr)</i> < 1 1–4 5–9 ≥ 10	33 151 135 32	<i>SIR</i> 1.09 (0.75–1.52) 1.05 (0.90–1.24) 0.92 (0.77–1.08) 1.08 (0.74–1.52)	Age, sex, calendar period of observation	Incidence study; cannot be certain who the user was; phones used under business accounts not included; details of phone use not available
Schüz et al. (2006c) Denmark, 1982–2002	65 542	1982–2002	Records of cellular service providers	Female breast (174)	Subscriber	711	1.04 (0.97–1.12)	Age, calendar year of observation	Incidence study; cannot be certain who the user was; phones used under business accounts not included; details of phone use not available
Schüz et al. (2006c) Denmark, 1982–2002	420 095	1982–2002	Records of cellular service providers	Eye (190)	Subscriber	38 (males) 6 (females)	0.94 (0.66–1.29) 1.10 (0.40–2.39)	Age, calendar year of observation	Incidence study; cannot be certain who the user was; phones used under business accounts not included; details of phone use not available

Table 2.18 (continued)

Reference, study location and period	Total No. of subjects	Follow-up period	Exposure assessment	Organ site (ICD code)	Exposure categories	No. of cases/deaths	Relative risk (95% CI)	Covariates	Comments
Schüz <i>et al.</i> (2006c) Denmark, 1982–2002	357 553	1982–2002	Records of cellular service providers	Testis (186)	Subscriber	522	1.05 (0.96–1.15)	Age, calendar year of observation	Incidence study; cannot be certain who the user was; phones used under business accounts not included; details of phone use not available
Schüz <i>et al.</i> (2006c) Denmark, 1982–2002	420 095	1982–2002	Records of cellular service providers	Salivary gland (142)	Subscriber	26 (males) 0 (females)	0.86 (0.56–1.26) 0.00 (0.00–1.02)	Age, calendar year of observation	Incidence study; cannot be certain who the user was; phones used under business accounts not included; details of phone use not available

d, day; h, hour; SIR, standardized incidence ratio; SMR, standardized mortality ratio; yr, year

lifetime use, nor year of first use. The incidence of NHL was elevated among men who had used cell phones for > 8 years (OR, 2.4; 95% CI, 0.8–7.0, based on 17 cases).

2.3.3 Uveal (ocular) melanoma

In a study of 118 cases and 475 controls, [Stang et al. \(2001\)](#) reported an association between assessed occupational use of mobile phones and risk of uveal melanoma ([Table 2.19](#)). Methods for this study are described in greater detail in Section 2.1.3. [There was no adjustment for exposure to ultraviolet radiation, which may be a relevant confounder. Exposure information was crude, and concerns were raised about possible bias in the self-reported data in this small study ([Johansen et al., 2002](#)).]

The same investigators carried out a much larger case–control study (455 cases; aged 20–74 years) between 2002 and 2004 using a more refined exposure-assessment instrument ([Stang et al., 2009; Table 2.19](#)). Three control series were enrolled. One included 827 population controls selected from census data from local districts and matched to case patients on age (5-year age groups), sex and region of residence. A second control series included 180 ophthalmology patients – recruited from practices of the same ophthalmologists who had referred the case patients with uveal melanoma – who had a newly diagnosed benign disease of the eye. The third control group consisted of 187 siblings of cases. Participation rates were 94% for the case patients, 57% for the population and sibling control subjects, and 52% for the ophthalmologists control subjects. The risk of uveal melanoma was not associated with regular use of mobile phones based on any of the three control series (with population controls: OR, 0.7; 95% CI, 0.5–1.0; with ophthalmologist controls: OR, 1.1; 95% CI, 0.6–2.3; and with sibling controls: OR, 1.2 95% CI, 0.5–2.6). There were no associations with cumulative measures of exposure (years of

use, number of calls) based on any of the control series. [The Working Group noted the higher participation rate for cases than for controls and the attendant possibility of selection bias.]

The incidence of cancer of the eye (histology not specified, but likely to include a high proportion of melanomas) was not increased in a large cohort of Danish mobile-phone subscribers relative to the general population in a study that reported follow-up until 2002 ([Schüz et al., 2006c; Table 2.18](#)).

The substantial increase in use of mobile telephones has not been accompanied by an increase in uveal (ocular) melanoma in the USA up to 2000 ([Inskip et al., 2003, 2004](#)), nor was an increase seen in Denmark up to 1996 ([Johansen et al., 2002](#)). The annual percentage change in the USA was –0.7% for males (95% CI, –2.3–0.9) and –1.2% for females (95% CI, –2.5–0.0) ([Inskip et al., 2003](#)). Narrowing the time window to the 1990s failed to reveal any sign of a recent increase in incidence.

2.3.4 Cancer of the testis

The potential exists for the testes to be exposed to RF radiation if a mobile phone is kept in a trouser pocket while in stand-by mode, or when using a hands-free device. The incidence of cancer of the testis was not increased among 357 533 Danish male mobile-phone subscribers relative to that in the general population, based on an average follow-up of 8 years (maximum, 21 years) (SIR, 1.05; 95% CI, 0.96–1.15) ([Schüz et al., 2006c; Table 2.18](#)).

A case–control study of cell-phone use and testicular cancer in Sweden (542 seminomas, 346 non-seminomas, and 870 controls) gave null results for both histopathological subtypes ([Hardell et al., 2007b; Table 2.18](#)). Cases were diagnosed between 1993 and 1997.

Table 2.19 Case-control studies of leukaemia, lymphoma and other cancers and use of mobile phones

Reference, study location and period	Total cases	Total controls	Control source (hospital, population)	Exposure assessment	Organ site (ICD code)	Exposure categories	Exposed cases	Odds ratio (95% CI)	Covariates	Comments
Kaufman et al. (2009) Thailand, 1997–2003	180	756	Hospital	Interviewer-administered standardized questionnaire	Leukaemia (bone marrow) (204–207)	Ever use Use of GSM services	35 NR	1.5 (1.0–2.4) 2.1 (1.1–4.0)	Matching factors age, sex, area of residence, income, exposure to benzene, solvents, pesticides, or power lines	No association with duration of ownership, lifetime hours of use, or h/yr; short duration of use (median, 24–26 months); also evaluated by subtype of leukaemia
Cooke et al. (2010) United Kingdom, 2003–09	806	585	Non-blood relatives	Interviewer-administered standardized questionnaire	Leukaemia (204–207) exclusive of CLL (204.1)	Never, or non-regular use Regular use Lifetime years of use: 0.5–4 5–9 10–14 ≥ 15 <i>P</i> for trend	132 674 201 309 110 42 0.30	1.00 1.06 (0.76–1.46) 0.97 (0.67–1.39) 1.10 (0.77–1.58) 1.04 (0.67–1.61) 1.63 (0.81–3.28)	Age, sex, SES, area of residence, ethnicity, smoking, interview lag-time and period	No significant associations with year since first use, lifetime years of use, cumulative number of calls, or cumulative hours of use; low participation rate (50%)
Hardell et al. (2005) Sweden, 1999–2002	910	1016	Population	Mail questionnaire + telephone	NHL	<i>Use of analogue and digital phones (yr)</i> > 1 > 5 > 10	130 123 70	1.02 (0.73–1.44) 1.04 (0.73–1.46) 0.91 (0.61–1.36)	Age, sex, year of diagnosis	Ages 18–74 yr; no differences by subtype of NHL

Table 2.19 (continued)

Reference, study location and period	Total cases	Total controls	Control source (hospital, population)	Exposure assessment	Organ site (ICD code)	Exposure categories	Exposed cases	Odds ratio (95% CI)	Covariates	Comments
Linnet et al. (2006) USA, 1998–2000	551	462	Population	Mail + home questionnaire	NHL	Ever use	234	1.0 (0.7–1.3)	Age, ethnicity, education, geographic site	Risk also not significantly associated with min/wk, duration, or year when use started. Results were null for total NHL, large B-cell and follicular lymphoma
						Cumulative use (h):				
						≤ 78	35	0.8 (0.4–1.4)		
						79–208	23	0.8 (0.4–1.5)		
						≥ 209	35	1.1 (0.6–2.1)		
Stang et al. (2001) Germany, 1995–98	118	475	Population, hospital	Interview	Uveal melanoma (190)	<i>Probable/certain mobile-phone use</i>		Age, sex, geographic area	Crude exposure assessment; low prevalence of exposure; few long-term users	
						Ever	6			4.2 (1.2–14.5)
						≥ 5 yr in past	3	4.9 (0.5–51.0)		
Stang et al. (2009) Germany 2002–04	459	1194	Population, ophthalmology, siblings	Questionnaire	Uveal melanoma (190)	Regular use	30	<i>Relative risk</i> 0.7 (0.5–1.0)	Age, sex, residence	RR estimates based on population controls; low participation rate among controls (57%)
						Cumulative use (yr):				
						≤ 4	17	0.8 (0.5–1.2)		
						5–9	11	0.6 (0.4–1.0)		
						≥ 10	2	0.6 (0.3–1.4)		

Table 2.19 (continued)

Reference, study location and period	Total cases	Total controls	Control source (hospital, population)	Exposure assessment	Organ site (ICD code)	Exposure categories	Exposed cases	Odds ratio (95% CI)	Covariates	Comments
Hardell et al. (2007b) Sweden 1993–97	888 (542 seminoma; 346 non-seminoma)	870	Population	Questionnaire	Testicular cancer (178)	<i>Cumulative use of mobile-phone (h)</i>		1.3 (0.9–1.8)	Age, year of diagnosis, cryptorchidism	Similar null results for seminoma and non-seminoma, as well as by latency
						Analogue:				
						1–127	102			
						128–547	46			
						> 547	27			
						Digital:				
						1–127	85			
128–547	48									
> 547	31									
Auvinen et al. (2002) Finland, 1996	34	170	Population	Mobile-phone subscriber lists	Salivary gland cancer (142)	Ever (analogue and digital)		1.3 (0.4–4.7)	Age, sex	Small number of cases; limited information on exposure; results shown are for analogue and digital phones combined
						Duration (yr):				
						< 1	0			
						1–2	3			
> 2	1									
Hardell et al. (2004) Sweden, 1994–2000	267	1053	Population	Questionnaire	Malignant and benign salivary-gland tumours (142, 210)	Ever use (analogue)		0.92 (0.58–1.44)	Age, sex	Only living cases included; latency results are for analogue phones. No cases among long-term users of digital phones
						Ever use (digital)				
						Latency (yr):				
						> 5	17			
						> 10	6			

Table 2.19 (continued)

Reference, study location and period	Total cases	Total controls	Control source (hospital, population)	Exposure assessment	Organ site (ICD code)	Exposure categories	Exposed cases	Odds ratio (95% CI)	Covariates	Comments
Lönn <i>et al.</i> (2006) Denmark, Sweden, 2000–02	60	681	Population	Interviewer-administered standardized questionnaire	Malignant parotid gland (ICD codes not reported)	Never regular use of mobile phone	35	1.0	Age, sex, geographic region, education	
						Regular use	25	0.7 (0.4–1.3)		
						<i>Time since start of use (yr)</i>				
						< 5	14	0.7 (0.3–1.3)		
						5–9	8	0.7 (0.3–1.7)		
						≥ 10	2	0.4 (0.1–2.6)		
						<i>Cumulative use (h)</i>				
						< 30	7	0.7 (0.3–1.6)		
						30–449	11	0.7 (0.3–1.4)		
						≥ 450	5	0.6 (0.2–1.8)		
Lönn <i>et al.</i> (2006) Sweden, 2000–02	112	321	Population	Interviewer-administered standardized questionnaire	Benign pleomorphic adenomas (ICD codes not reported)	Never regular use of mobile phone	35	1.0	Age, sex, geographic region, education	
						Regular use	77	0.9 (0.5–1.5)		
						<i>Time since start of use (yr)</i>				
						< 5	47	1.0 (0.6–1.8)		
						5–9	23	0.8 (0.4–1.5)		
						≥ 10	7	1.4 (0.5–3.9)		
						<i>Cumulative use (h)</i>				
						< 30	20	1.1 (0.6–2.3)		
						30–449	34	0.9 (0.5–1.6)		
						≥ 450	22	1.0 (0.5–2.1)		

Risk for ipsilateral use: OR, 1.4 (95% CI, 0.2–2.2)

Table 2.19 (continued)

Reference, study location and period	Total cases	Total controls	Control source (hospital, population)	Exposure assessment	Organ site (ICD code)	Exposure categories	Exposed cases	Odds ratio (95% CI)	Covariates	Comments	
Sadetzki et al. (2008) Israel, 2001–03	460 (48 malignant; 402 benign)	1266	Population	Personal interview	Malignant and benign salivary-gland tumours (142, 210)	Not regular use of mobile phone < 1 yr	175	1.0	Unadjusted (cigarette smoking was considered but did not change OR) Gender, interview date, age, continent of birth	Separate analyses for benign and malignant tumours, with similar results	
						Regular use	285	0.87 (0.68–1.13)			
						<i>Duration of use (yr)</i>					
						1–4.9	138	0.84 (0.63–1.12)			
						5–9.9	134	0.92 (0.67–1.27)			
						≥ 10	13	1.0 (0.48–2.09)			
						<i>Time since start of use (yr)</i>					
						1–4.9	138	0.82 (0.61–1.10)			
						5–9.9	134	0.95 (0.70–1.30)			
						≥ 10	13	0.86 (0.42–1.77)			
<i>Cumulative use (h)</i>											
≤ 266.3	121	0.82 (0.62–1.09)	OR for ipsilateral use: 1.49 (95% CI, 1.05–2.13)								
266.4–1034.9	80	1.03 (0.72–1.47)									
≥ 1 035	83	1.09 (0.75–1.60)									

Table 2.19 (continued)

Reference, study location and period	Total cases	Total controls	Control source (hospital, population)	Exposure assessment	Organ site (ICD code)	Exposure categories	Exposed cases	Odds ratio (95% CI)	Covariates	Comments			
Duan <i>et al.</i> (2011) China 1993–2010	136	2051	Hospital	Personal or telephone interviews	Salivary-gland cancer (142)	Regular use model	91	1.14 (0.72–1.81)	Age, sex, residential area, marital status, education, income, smoking status	Possible over-parameterization; difficult to reconcile overall RR with exposure category-specific RRs			
						<i>No. of calls since first use</i>							
						≤ 24 000	78	1.78 (1.12–2.84)			As above	Implausible RR and CI for highest exposure category (one exposed case)	
						24 001–42 000	12	1.76 (1.01–2.51)					
						> 42 000	1	15.36 (13.34–17.38)					
						<i>Duration of use (yr)</i>							
						0–6	67	1.69 (1.05–2.73)			As above	Preceding comments raise serious questions about analysis	
						7–8	7	3.69 (2.82–4.57)					
9–10	2	7.70 (6.20–9.20)											
> 10	15	4.14 (1.76–9.69)											

CLL, chronic lymphocytic leukaemia; GSM, Global System for Mobile Communications; min, minute; NHL, non-Hodgkin lymphoma; NR, not reported; RR, relative risk; SES, socioeconomic status; h, hour; yr, year

2.3.5 Cancers of the parotid gland

The salivary glands are potentially exposed to high doses of RF radiation from mobile phones, particularly the parotid gland on the side of the head on which the phone is used. Five case-control studies and one cohort study have addressed a possible relationship between cancer of the salivary gland and use of mobile phones.

An early case-control study by [Auvinen et al. \(2002\)](#) ([Table 2.19](#)) gave null results, but was quite small (34 cases), included only malignant tumours, and provided limited information about details of phone use. Cases were ascertained from the Finnish Cancer Registry and controls from the nationwide population registry. Personal identifiers were linked with subscription records for two cellular networks in 1996. [This register-based approach precludes selection bias to non-response as well as recall bias in the ascertainment of mobile phone use. Information on the frequency or duration of calls was not available, nor was mobile-phone use under a corporate account.]

A case-control study by [Hardell et al. \(2004\)](#) ([Table 2.19](#)) included 267 cases, considered both benign and malignant tumours of the parotid gland, and provided detailed exposure information. Again, the results were null. [The study included few people who had used mobile phones for > 10 years.]

A case-control study by [Lönn et al. \(2006\)](#) ([Table 2.19](#)), which was part of the INTERPHONE study, included 172 cases (benign and malignant parotid tumours combined), 681 controls (for the 60 malignant cases), and 321 controls (for the 112 benign cases). The study found no association with regular use of mobile phones for either malignant or benign parotid tumours. The surrogate exposure metrics considered included frequency of use, duration of regular use, time since first regular use, cumulative use and cumulative number of calls. For benign tumours, there was a slightly elevated risk associated

with ipsilateral use of mobile phones (OR, 1.4; 95% CI, 0.2–2.2, based on 51 cases) but not for contralateral tumours (OR, 0.7; 95% CI, 0.4–1.1, based on 35 cases). [There may have been bias in reporting of laterality of phone use.]

A case-control study of tumours of the parotid gland was conducted in Israel, where use of mobile phones was reported to be very high ([Sadetzki et al., 2008](#); [Table 2.19](#)). This was the largest study of this type (402 cases with benign tumours, 58 with malignant tumours, and 1266 controls), also conducted as part of the INTERPHONE study. Cases were diagnosed at age 18 years or more during 2001 and 2003. In the main analyses, no increased risk was observed for any of the exposure surrogates examined. Laterality analyses generally indicated increased risk for ipsilateral use and reduced risk for contralateral use, e.g. for > 266 hours of cumulative call time with no hands-free devices, the odds ratio for ipsilateral use was 1.49 (95% CI, 1.05–2.13, based on 115 cases), while the odds ratio for contralateral use was 0.84 (95% CI, 0.55–1.28, based on 48 cases). Stratified analyses according to type of residence produced a somewhat higher odds ratio for rural and mixed rural/urban areas than for poor urban areas. For rural and rural/urban users, exposure-response associations were significant for cumulative call time ($P = 0.04$) and borderline significant for number of calls ($P = 0.06$). When the analyses were restricted to regular users only, taking the lowest category of use as the reference, increased odds ratios were found if time since start of use was > 5 years before diagnosis (OR, 1.40; 95% CI, 1.03–1.90, based on 134 cases) and for the highest exposure category of cumulative number of calls (OR, 1.51; 95% CI, 1.05–2.17, based on 81 cases) and duration of calls (OR, 1.50; 95% CI, 1.04–2.16, based on 83 cases). [The fact that there were increased odds ratios for ipsilateral tumours and decreased odds ratios for contralateral tumours suggested the presence of bias in reporting side of use.]

In a hospital-based case–control study of epithelial cancers of the parotid gland conducted in China between 1993 and 2010 (136 cases, 2051 controls), no overall association of cancer risk with regular use of mobile phones was observed ([Duan *et al.*, 2011](#); [Table 2.19](#)). The authors also evaluated several more detailed exposure metrics and commented that several showed evidence of a dose–response relationship. [This interpretation was made uncertain by aspects of variation in the odds ratios. In several instances, there was no indication of a gradient in risk, but a very large increase in the odds ratio for the highest exposure category. Perhaps more puzzling was the fact that, for many of the exposure variables, odds ratios for all categories of exposure were higher than the overall odds ratio of 1.14. One would expect the overall odds ratio for regular use to be a weighted average of category-specific odds ratios. For number of calls since first use, the authors reported an odds ratio of 15.36 (95% CI, 13.34–17.38) for the highest exposure category, based on one exposed case. This cannot be correct and raises doubt about other analyses. The odds ratio presented may be 1/OR, as 0.7% of cases and 12.6% of controls were in this category.]

The incidence of cancers of the salivary gland was not increased relative to that in the general population in a large cohort of mobile-phone subscribers in Denmark followed up for up to 21 years ([Schüz *et al.*, 2006c](#); [Table 2.19](#)).

A recent descriptive study reported an increase in the occurrence of cancer of the parotid gland (not incidence rate) in Israel, which appeared to begin around 1990 and continue through 2006 ([Czerninski *et al.*, 2011](#)). [Interpretation of these findings was difficult given the increase in population size in Israel, possible improvements over time in the ascertainment of cancers of the parotid gland, a substantial shift in diagnoses over time from the category “major salivary gland cancers, not otherwise specified” to more precisely defined types – the large majority of which were cancers of the parotid gland – and the lack of information about mobile-phone use.]

2.3.6 Other cancers

(a) Cancer of the breast

[There was little information concerning mobile-phone use and risk of breast cancer.] Breast cancer did not occur more often than expected based on incidence rates in the general population in a cohort of 65 542 Danish female mobile-phone subscribers followed from as early as 1982 until 1995 ([Schüz *et al.*, 2006c](#); [Table 2.18](#)).

(b) Cancer of the skin

In a case–control study of cutaneous melanoma in the head and neck region (347 cases, 1184 controls), [Hardell *et al.* \(2011b\)](#) reported no overall association with use of mobile phones (OR, 1.0; 95% CI, 0.7–1.3, based on 223 cases) or cordless phones (OR, 0.9; 95% CI, 0.6–1.2, based on 138 cases), nor among those with heavier use. Use of cordless phones, but not mobile phones, was associated with an increased risk of melanoma in the temporal region, cheek, and ear for the group with 1–5 year latency among those with heavier use (OR, 2.1; 95% CI, 1.1–3.8 for > 365 cumulative hours, based on 21 cases). [The overall pattern in the data pointed more in the direction of no effect. The odds ratio mentioned in the Abstract for the latency period of 1–5 years did not match that in Table 2 of the published manuscript regarding mobile-phone use.]

[To date, there have been no studies of non-melanoma skin cancer in relation to mobile-phone use.]

(c) Other cancer sites

Subscribers to mobile-phone services in Denmark followed from as early as 1982 until 2002 did not show significantly elevated incidence rates of cancers of the lung, larynx, bladder, buccal cavity, oesophagus, liver, uterine cervix, stomach, kidney, pancreas, prostate or other sites, relative to the incidence rates in the Danish general population ([Schüz *et al.*, 2006c](#)).

References

- Ahlbom A, Feychting M, Green A *et al.* ICNIRP (International Commission for Non-Ionizing Radiation Protection) Standing Committee on Epidemiology (2009). Epidemiologic evidence on mobile phones and tumor risk: a review. *Epidemiology*, 20: 639–652. doi:10.1097/EDE.0b013e3181b0927d PMID:19593153
- Armstrong B, Thériault G, Guénel P *et al.* (1994). Association between exposure to pulsed electromagnetic fields and cancer in electric utility workers in Quebec, Canada, and France. *Am J Epidemiol*, 140: 805–820. PMID:7977291
- Auvinen A, Hietanen M, Luukkonen R, Koskela RS (2002). Brain tumors and salivary gland cancers among cellular telephone users. *Epidemiology*, 13: 356–359. doi:10.1097/00001648-200205000-00018 PMID:11964939
- Baldi I, Coureau G, Jaffré A *et al.* (2011). Occupational and residential exposure to electromagnetic fields and risk of brain tumors in adults: a case-control study in Gironde, France. *Int J Cancer*, 129: 1477–1484. doi:10.1002/ijc.25765 PMID:21792884
- Baumgardt-Elms C, Ahrens W, Bromen K *et al.* (2002). Testicular cancer and electromagnetic fields (EMF) in the workplace: results of a population-based case-control study in Germany. *Cancer Causes Control*, 13: 895–902. doi:10.1023/A:1021999000651 PMID:12588085
- Berg G, Schüz J, Samkange-Zeeb F, Blettner M (2005). Assessment of radiofrequency exposure from cellular telephone daily use in an epidemiological study: German Validation study of the international case-control study of cancers of the brain—INTERPHONE-Study. *J Expo Anal Environ Epidemiol*, 15: 217–224. doi:10.1038/sj.jea.7500390 PMID:15266354
- Berg G, Spallek J, Schüz J *et al.* INTERPHONE Study Group, Germany (2006). Occupational exposure to radio frequency/microwave radiation and the risk of brain tumors: INTERPHONE Study Group, Germany. *Am J Epidemiol*, 164: 538–548. doi:10.1093/aje/kwj247 PMID:16873421
- Cardis E, Armstrong BK, Bowman JD *et al.* (2011). Risk of brain tumours in relation to estimated RF dose from mobile phones: results from five Interphone countries. *Occup Environ Med*, 68:631–640 doi:10.1136/oemed-2011-100155 PMID:21659469
- Cardis E, Deltour I, Mann S *et al.* (2008). Distribution of RF energy emitted by mobile phones in anatomical structures of the brain. *Phys Med Biol*, 53: 2771–2783. doi:10.1088/0031-9155/53/11/001 PMID:18451464
- Cardis E, Richardson L, Deltour I *et al.* (2007). The INTERPHONE study: design, epidemiological methods, and description of the study population. *Eur J Epidemiol*, 22: 647–664. doi:10.1007/s10654-007-9152-z PMID:17636416
- Christensen HC, Schüz J, Kosteljanetz M *et al.* (2004). Cellular telephone use and risk of acoustic neuroma. *Am J Epidemiol*, 159: 277–283. doi:10.1093/aje/kwh032 PMID:14742288
- Christensen HC, Schüz J, Kosteljanetz M *et al.* (2005). Cellular telephones and risk for brain tumors: a population-based, incident case-control study. *Neurology*, 64: 1189–1195. doi:10.1212/01.WNL.0000156351.72313.D3 PMID:15824345
- Cook A, Woodward A, Pearce N, Marshall C (2003). Cellular telephone use and time trends for brain, head and neck tumours. *NZ Med J*, 116: U457 PMID:12838353
- Cooke R, Laing S, Swerdlow AJ (2010). A case-control study of risk of leukaemia in relation to mobile phone use. *Br J Cancer*, 103: 1729–1735. doi:10.1038/sj.bjc.6605948 PMID:20940717
- Cooper D, Hemming K, Saunders P (2001). Re: “Cancer incidence near radio and television transmitters in Great Britain. I. Sutton Coldfield transmitter; II. All high power transmitters”. *Am J Epidemiol*, 153: 202–204. doi:10.1093/aje/153.2.202 PMID:11159167
- Czerninski R, Zini A, Sgan-Cohen HD (2011). Risk of parotid malignant tumors in Israel (1970–2006). *Epidemiology*, 22: 130–131. doi:10.1097/EDE.0b013e3181feb9f0 PMID:21150362
- Davis RL & Mostofi FK (1993). Cluster of testicular cancer in police officers exposed to hand-held radar. *Am J Ind Med*, 24: 231–233. doi:10.1002/ajim.4700240209 PMID:8213849
- de Vocht F, Burstyn I, Cherrie JW (2011a). Time trends (1998–2007) in brain cancer incidence rates in relation to mobile phone use in England. *Bioelectromagnetics*, 32: 334–339. doi:10.1002/bem.20648 PMID:21280060
- de Vocht F, Burstyn I, Cherrie JW (2011b). Authors’ Reply to Kundi’s Comments on deVocht *et al.* “Time trends (1998–2007) in brain cancer incidence rates in relation to mobile phone use in England”. *Bioelectromagnetics*, doi:10.1002/bem.20678
- Degrave E, Meeusen B, Grivegnée AR *et al.* (2009). Causes of death among Belgian professional military radar operators: a 37-year retrospective cohort study. *Int J Cancer*, 124: 945–951. doi:10.1002/ijc.23988 PMID:19035449
- Deltour I, Johansen C, Auvinen A *et al.* (2009). Time trends in brain tumor incidence rates in Denmark, Finland, Norway, and Sweden, 1974–2003. *J Natl Cancer Inst*, 101: 1721–1724. doi:10.1093/jnci/djp415 PMID:19959779
- Deltour I, Johansen C, Auvinen A *et al.* (2010). Response: Re: Time Trends in Brain Tumor Incidence Rates in Denmark, Finland, Norway, and Sweden, 1974–2003. *J Natl Cancer Inst*, 102: 742–743. doi:10.1093/jnci/djq123
- Dolk H, Elliott P, Shaddick G *et al.* (1997b). Cancer incidence near radio and television transmitters in Great Britain. II. All high power transmitters. *Am J Epidemiol*, 145: 10–17. PMID:8982017

- Dolk H, Shaddick G, Walls P *et al.* (1997a). Cancer incidence near radio and television transmitters in Great Britain. I. Sutton Coldfield transmitter. *Am J Epidemiol*, 145: 1–9. PMID:8982016
- Dreyer NA, Loughlin JE, Rothman KJ (1999). Cause-specific mortality in cellular telephone users. *JAMA*, 282: 1814–1816. doi:10.1001/jama.282.19.1814-a PMID:10573269
- Duan Y, Zhang Z, Bu RF (2011). Correlation between cellular phone use and epithelial parotid gland malignancies. *Int J Oral Medicine*, 40: 9966–972..
- Eger H, Hagen KU, Lucas B *et al.* (2004). The influence of being physically near to a cell phone transmission mast on the incidence of cancer. *Umwelt-medizin Gesellschaft*, 17: 1–7.
- Eger H & Neppe F (2009). Krebsinzidenz von Anwohnern im Umkreis einer Mobilfunkseendeanlage in Westfalen. *Umwelt-medizin Gesellschaft*, 22: 55–60.
- Elliott P, Toledano MB, Bennett J *et al.* (2010). Mobile phone base stations and early childhood cancers: case-control study. *BMJ*, 340: jun22 1c3077 doi:10.1136/bmj.c3077 PMID:20570865
- Frei P, Mohler E, Bürgi A *et al.*; QUALIFEX Team (2010). Classification of personal exposure to radio frequency electromagnetic fields (RF-EMF) for epidemiological research: Evaluation of different exposure assessment methods. *Environ Int*, 36: 714–720. doi:10.1016/j.envint.2010.05.005 PMID:20538340
- Gavin AT & Catney D (2006). Addressing a community's cancer cluster concerns. *The Ulster Medical Society*, 75: 195–199.
- Gousias K, Markou M, Voulgaris S *et al.* (2009). Descriptive epidemiology of cerebral gliomas in northwest Greece and study of potential predisposing factors, 2005–2007. *Neuroepidemiology*, 33: 89–95. doi:10.1159/000222090 PMID:19494549
- Grayson JK (1996). Radiation exposure, socioeconomic status, and brain tumor risk in the US Air Force: a nested case-control study. *Am J Epidemiol*, 143: 480–486. doi:10.1093/oxfordjournals.aje.a008768 PMID:8610663
- Groves FD, Page WF, Gridley G *et al.* (2002). Cancer in Korean war navy technicians: mortality survey after 40 years. *Am J Epidemiol*, 155: 810–818. doi:10.1093/aje/155.9.810 PMID:11978584
- Ha M, Im H, Kim BC *et al.* (2008). Five authors reply [Letter] *Am J Epidemiol*, 167: 884–885. doi:10.1093/aje/kwn013
- Ha M, Im H, Lee M *et al.* (2007). Radio-frequency radiation exposure from AM radio transmitters and childhood leukemia and brain cancer. *Am J Epidemiol*, 166: 270–279. doi:10.1093/aje/kwm083 PMID:17556764
- Ha M, Lim HJ, Cho SH *et al.* (2003). Incidence of cancer in the vicinity of Korean AM radio transmitters. *Arch Environ Health*, 58: 756–762. doi:10.3200/AEOH.58.12.756-762 PMID:15859510
- Hardell L, Hansson Mild K, Pålsson A, Hallquist A (2001). Ionizing radiation, cellular telephones and the risk for brain tumours. *Eur J Cancer Prev*, 10: 523–529. doi:10.1097/00008469-200112000-00007 PMID:11916351
- Hardell L, Hansson Mild K & Carlberg M (2002b). Case-control study on the use of cellular and cordless phones and the risk for malignant brain tumours. *Int J Radiat Biol*, 78: 931–936. doi:10.1080/09553000210158038 PMID:12465658
- Hardell L, Hansson Mild K & Carlberg M (2003). Further aspects on cellular and cordless telephones and brain tumours. *Int J Oncol*, 22: 399–407. PMID:12527940
- Hardell L & Carlberg M (2009). Mobile phones, cordless phones and the risk for brain tumours. *Int J Oncol*, 35: 5–17. doi:10.3892/ijo_00000307 PMID:19513546
- Hardell L, Carlberg M, Hansson Mild K (2006a). Pooled analysis of two case-control studies on the use of cellular and cordless telephones and the risk of benign brain tumours diagnosed during 1997–2003. *Int J Oncol*, 28: 509–518. PMID:16391807
- Hardell L, Carlberg M, Hansson Mild K (2006b). Pooled analysis of two case-control studies on use of cellular and cordless telephones and the risk for malignant brain tumours diagnosed in 1997–2003. *Int Arch Occup Environ Health*, 79: 630–639. doi:10.1007/s00420-006-0088-5 PMID:16541280
- Hardell L, Carlberg M, Hansson Mild K (2009). Epidemiological evidence for an association between use of wireless phones and tumor diseases. *Pathophysiology*, 16: 113–122. doi:10.1016/j.pathophys.2009.01.003 PMID:19268551
- Hardell L, Carlberg M, Hansson Mild K (2010). Mobile phone use and the risk for malignant brain tumors: a case-control study on deceased cases and controls. *Neuroepidemiology*, 35: 109–114. doi:10.1159/000311044 PMID:20551697
- Hardell L, Carlberg M, Hansson Mild K (2011a). Pooled analysis of case-control studies on malignant brain tumours and the use of mobile and cordless phones including living and deceased subjects. *Int J Oncol*, 38: 1465–1474. doi:10.3892/ijo.2011.947 PMID:21331446
- Hardell L, Carlberg M, Hansson Mild K, Eriksson M (2011b). Case-control study on the use of mobile and cordless phones and the risk for malignant melanoma in the head and neck region. *Pathophysiology*, 18: 325–333. doi:10.1016/j.pathophys.2011.06.001 PMID:21764571
- Hardell L, Carlberg M, Hansson Mild K (2006c). Case-control study of the association between the use of cellular and cordless telephones and malignant brain tumors diagnosed during 2000–2003. *Environ Res*, 100: 232–241. doi:10.1016/j.envres.2005.04.006 PMID:16023098
- Hardell L, Carlberg M, Ohlson CG *et al.* (2007b). Use of cellular and cordless telephones and risk of testicular

- cancer. *Int J Androl*, 30: 115–122. doi:10.1111/j.1365-2605.2006.00721.x PMID:17209885
- Hardell L, Carlberg M, Söderqvist F *et al.* (2007a). Long-term use of cellular phones and brain tumours: increased risk associated with use for > or =10 years. *Occup Environ Med*, 64: 626–632. doi:10.1136/oem.2006.029751 PMID:17409179
- Hardell L, Carlberg M, Söderqvist F, Hansson Mild K (2008). Meta-analysis of long-term mobile phone use and the association with brain tumours. *Int J Oncol*, 32: 1097–1103. PMID:18425337
- Hardell L, Eriksson M, Carlberg M *et al.* (2005). Use of cellular or cordless telephones and the risk for non-Hodgkin's lymphoma. *Int Arch Occup Environ Health*, 78: 625–632. doi:10.1007/s00420-005-0003-5 PMID:16001209
- Hardell L & Hallquist A, Hansson Mild K *et al.* (2002a). Cellular and cordless telephones and the risk for brain tumours. *Eur J Cancer Prev*, 11: 377–386. doi:10.1097/00008469-200208000-00010 PMID:12195165
- Hardell L, Hallquist A, Hansson Mild K *et al.* (2004). No association between the use of cellular or cordless telephones and salivary gland tumours. *Occup Environ Med*, 61: 675–679. doi:10.1136/oem.2003.011262 PMID:15258273
- Hardell L, Näsman A, Pahlson A *et al.* (1999). Use of cellular telephones and the risk for brain tumours: A case-control study. *Int J Oncol*, 15: 113–116. PMID:10375602
- Hardell L, Nasman A, Pahlson A, Hallquist A (2000). Case-control study on radiology work, medical x-ray investigations, and use of cellular telephones as risk factors for brain tumors. *MedGenMed*, 2: E2 PMID:11104448
- Hartikka H, Heinävaara S, Mäntylä R *et al.* (2009). Mobile phone use and location of glioma: a case-case analysis. *Bioelectromagnetics*, 30: 176–182. doi:10.1002/bem.20471 PMID:19142876
- Hayes RB, Brown LM, Potters LM *et al.* (1990). Occupation and risk for testicular cancer: a case-control study. *Int J Epidemiol*, 19: 825–831. doi:10.1093/ije/19.4.825 PMID:1964675
- Hepworth SJ, Schoemaker MJ, Muir KR *et al.* (2006). Mobile phone use and risk of glioma in adults: case-control study. *BMJ*, 332: 883–887. doi:10.1136/bmj.38720.687975.55 PMID:16428250
- Hocking B, Gordon IR, Grain HL, Hatfield GE (1996). Cancer incidence and mortality and proximity to TV towers. *Med J Aust*, 165: 601–605. PMID:8985435
- Hours M, Bernard M, Montestrucq L *et al.* (2007). [Cell Phones and Risk of brain and acoustic nerve tumours: the French INTERPHONE case-control study] *Rev Epidemiol Sante Publique*, 55: 321–332. PMID:17851009
- IARC (2002). Non-ionizing radiation, Part I: static and extremely low-frequency (ELF) electric and magnetic fields. *IARC Monogr Eval Carcinog Risks Hum*, 80: 1–395. PMID:12071196
- Inskip PD, Devesa SS, Fraumeni JF Jr (2003). Trends in the incidence of ocular melanoma in the United States, 1974–1998. *Cancer Causes Control*, 14: 251–257. doi:10.1023/A:1023684502638 PMID:12814204
- Inskip PD, Devesa SS, Fraumeni JF Jr (2004). The Authors Reply. *Cancer Causes Control*, 15: 101–102. doi:10.1023/B:CACO.0000016571.38245.83
- Inskip PD, Hoover RN, Devesa SS (2010). Brain cancer incidence trends in relation to cellular telephone use in the United States. *Neuro-oncol*, 12: 1147–1151. doi:10.1093/neuonc/noq077 PMID:20639214
- Inskip PD, Tarone RE, Hatch EE *et al.* (2001). Cellular-telephone use and brain tumors. *N Engl J Med*, 344: 79–86. doi:10.1056/NEJM200101113440201 PMID:11150357
- INTERPHONE Study Group (2010). Brain tumour risk in relation to mobile telephone use: results of the INTERPHONE international case-control study. *Int J Epidemiol*, 39: 675–694. doi:10.1093/ije/dyq079 PMID:20483835
- INTERPHONE Study Group (2011). Acoustic neuroma risk in relation to mobile telephone use: results of the INTERPHONE international case-control study. *Cancer Epidemiol*, 35: 453–464. doi:10.1016/j.canep.2011.05.012 PMID:21862434
- Johansen C, Boice J Jr, McLaughlin J, Olsen JH (2001). Cellular telephones and cancer—a nationwide cohort study in Denmark. *J Natl Cancer Inst*, 93: 203–207. doi:10.1093/jnci/93.3.203 PMID:11158188
- Johansen C, Boice JD Jr, McLaughlin JK *et al.* (2002). Mobile phones and malignant melanoma of the eye. *Br J Cancer*, 86: 348–349. doi:10.1038/sj.bjc.6600068 PMID:11875697
- Kan P, Simonsen SE, Lyon JL, Kestle JR (2008). Cellular phone use and brain tumor: a meta-analysis. *J Neurooncol*, 86: 71–78. doi:10.1007/s11060-007-9432-1 PMID:17619826
- Karipidis KK, Benke G, Sim MR *et al.* (2007). Occupational exposure to ionizing and non-ionizing radiation and risk of glioma. *Occup Med (Lond)*, 57: 518–524. doi:10.1093/occmed/kqm078 PMID:17728306
- Kaufman DW, Anderson TE, Issaragrisil S (2009). Risk factors for leukemia in Thailand. *Ann Hematol*, 88: 1079–1088. doi:10.1007/s00277-009-0731-9 PMID:19294385
- Khurana VG, Teo C, Kundi M *et al.* (2009). Cell phones and brain tumors: a review including the long-term epidemiologic data. *Surg Neurol*, 72: 205–215. doi:10.1016/j.surneu.2009.01.019 PMID:19328536
- Klaeboe L, Blaasaas KG, Tynes T (2007). Use of mobile phones in Norway and risk of intracranial tumours. *Eur J Cancer Prev*, 16: 158–164. doi:10.1097/01.cej.0000203616.77183.4c PMID:17297392
- Lagorio S, Rossi S, Vecchia P *et al.* (1997). Mortality of plastic-ware workers exposed to radiofrequencies. *Bioelectromagnetics*, 18: 418–421.

- doi:10.1002/(SICI)1521-186X(1997)18:6<418::AID-BEM3>3.0.CO;2-5 PMID:9261538
- Lahkola A, Auvinen A, Raitanen J *et al.* (2007). Mobile phone use and risk of glioma in 5 North European countries. *Int J Cancer*, 120: 1769–1775. doi:10.1002/ijc.22503 PMID:17230523
- Lahkola A, Salminen T, Auvinen A (2005). Selection bias due to differential participation in a case-control study of mobile phone use and brain tumors. *Ann Epidemiol*, 15: 321–325. doi:10.1016/j.annepidem.2004.12.009 PMID:15840544
- Lahkola A, Salminen T, Raitanen J *et al.* (2008). Meningioma and mobile phone use—a collaborative case-control study in five North European countries. *Int J Epidemiol*, 37: 1304–1313. doi:10.1093/ije/dyn155 PMID:18676984
- Lahkola A, Tokola K, Auvinen A (2006). Meta-analysis of mobile phone use and intracranial tumors. *Scand J Work Environ Health*, 32: 171–177. PMID:16804618
- Larjavaara S, Schüz J, Swerdlow A *et al.* (2011). Location of gliomas in relation to mobile telephone use: a case-case and case-specular analysis. *Am J Epidemiol*, 174: 2–11. doi:10.1093/aje/kwr071 PMID:21610117
- Lehrer S, Green S, Stock RG (2011). Association between number of cell phone contracts and brain tumor incidence in nineteen U.S. States. *J Neurooncol*, 101: 505–507. doi:10.1007/s11060-010-0280-z PMID:20589524
- Lilienfeld AM, Tonascia J, Libauer C *et al.* (1978). *Foreign Service Study: Evaluation of Foreign Service and Other Employees from Selected Eastern European Posts*. NTIS Document No. PB-28B 163/9GA, pp. 436
- Linnet MS, Taggart T, Severson RK *et al.* (2006). Cellular telephones and non-Hodgkin lymphoma. *Int J Cancer*, 119: 2382–2388. doi:10.1002/ijc.22151 PMID:16894556
- Lönn S, Ahlbom A, Christensen HC *et al.* (2006). Mobile phone use and risk of parotid gland tumor. *Am J Epidemiol*, 164: 637–643. doi:10.1093/aje/kwj242 PMID:16818464
- Lönn S, Ahlbom A, Hall P, Feychting M Swedish INTERPHONE Study Group (2005). Long-term mobile phone use and brain tumor risk. *Am J Epidemiol*, 161: 526–535. doi:10.1093/aje/kwi091 PMID:15746469
- Lönn S, Klaeboe L, Hall P *et al.* (2004). Incidence trends of adult primary intracerebral tumors in four Nordic countries. *Int J Cancer*, 108: 450–455. doi:10.1002/ijc.11578 PMID:14648713
- Maskarinec G, Cooper J, Swygert L (1994). Investigation of increased incidence in childhood leukemia near radio towers in Hawaii: preliminary observations. *J Environ Pathol Toxicol Oncol*, 13: 33–37. PMID:7823291
- Merzenich H, Schmiedel S, Bennack S *et al.* (2008). Childhood leukemia in relation to radio frequency electromagnetic fields in the vicinity of TV and radio broadcast transmitters. *Am J Epidemiol*, 168: 1169–1178. doi:10.1093/aje/kwn230 PMID:18835863
- Meyer M, Gärtig-Daug A, Radespiel-Tröger M (2006). Mobilfunkbasisstationen und Krebshäufigkeit in Bayern [Mobile phone base stations and cancer incidence in Bavaria] [German] *Umweltmed Forsch Prax*, 11: 89–97.
- Michelozzi P, Capon A, Kirchmayer U *et al.* (2002). Adult and childhood leukemia near a high-power radio station in Rome, Italy. *Am J Epidemiol*, 155: 1096–1103. doi:10.1093/aje/155.12.1096 PMID:12048223
- Milham S Jr (1988a). Increased mortality in amateur radio operators due to lymphatic and hematopoietic malignancies. *Am J Epidemiol*, 127: 50–54. PMID:3422125
- Milham S Jr (1988b). Mortality by license class in amateur radio operators. *Am J Epidemiol*, 128: 1175–1176. PMID:3189292
- Morgan RW, Kelsh MA, Zhao K *et al.* (2000). Radiofrequency exposure and mortality from cancer of the brain and lymphatic/hematopoietic systems. *Epidemiology*, 11: 118–127. doi:10.1097/00001648-200003000-00007 PMID:11021607
- Muscat JE, Hinsvark M, Malkin M (2006). Mobile telephones and rates of brain cancer. *Neuroepidemiology*, 27: 55–56. doi:10.1159/000094381 PMID:16825795
- Muscat JE, Malkin MG, Shore RE *et al.* (2002). Handheld cellular telephones and risk of acoustic neuroma. *Neurology*, 58: 1304–1306. PMID:11971109
- Muscat JE, Malkin MG, Thompson S *et al.* (2000). Handheld cellular telephone use and risk of brain cancer. *JAMA*, 284: 3001–3007. doi:10.1001/jama.284.23.3001 PMID:11122586
- Myung SK, Ju W, McDonnell DD *et al.* (2009). Mobile phone use and risk of tumors: a meta-analysis. *J Clin Oncol*, 27: 5565–5572. doi:10.1200/JCO.2008.21.6366 PMID:19826127
- Nelson PD, Toledano MB, McConville J *et al.* (2006). Trends in acoustic neuroma and cellular phones: is there a link? *Neurology*, 66: 284–285. doi:10.1212/01.wnl.0000194218.79519.ea PMID:16434678
- Nomura E, Ioka A, Tsukuma H (2011). Trends in the incidence of primary intracranial tumors in Osaka, Japan. *Jpn J Clin Oncol*, 41: 291–294. doi:10.1093/jjco/hyq204 PMID:21273377
- Oberfeld G (2008). [Environmental Epidemiological Study of Cancer Incidence in the Municipalities of Hausmannstätten & Vasoldsberg (Austria).] Amt der Steiermärkischen Landesregierung, Fachabteilung für das Gesundheitswesen (Landessanitätsdirektion), Printcenter University of Salzburg, Graz, Austria. Available at <http://www.verwaltung.steiermark.at/cms/ziel/21212/DE/> (disabled link) (in German).
- Park SK, Ha M, Im HJ (2004). Ecological study on residences in the vicinity of AM radio broadcasting towers and cancer death: preliminary observations in Korea. *Int Arch Occup Environ Health*, 77: 387–394. doi:10.1007/s00420-004-0512-7 PMID:15338224

- Propp JM, McCarthy BJ, Davis FG, Preston-Martin S (2006). Descriptive epidemiology of vestibular schwannomas. *Neuro-oncol*, 8: 1–11. doi:10.1215/S1522851704001097 PMID:16443943
- Richter E, Berman T, Ben-Michael E *et al.* (2000). Cancer in radar technicians exposed to radiofrequency/microwave radiation: sentinel episodes. *Int J Occup Environ Health*, 6: 187–193. PMID:10926722
- Robinette CD, Silverman C, Jablon S (1980). Effects upon health of occupational exposure to microwave radiation (radar). *Am J Epidemiol*, 112: 39–53. PMID:7395854
- Röösli M, Michel G, Kuehni CE, Spoerri A (2007). Cellular telephone use and time trends in brain tumour mortality in Switzerland from 1969 to 2002. *Eur J Cancer Prev*, 16: 77–82. doi:10.1097/01.cej.0000203618.61936.cd PMID:17220708
- Sadetzki S, Chetrit A, Jarus-Hakak A *et al.* (2008). Cellular phone use and risk of benign and malignant parotid gland tumors—a nationwide case-control study. *Am J Epidemiol*, 167: 457–467. doi:10.1093/aje/kwm325 PMID:18063591
- Saika K & Katanoda K (2011). Comparison of time trends in brain and central nervous system cancer mortality (1990–2006) between countries based on the WHO mortality database. *Jpn J Clin Oncol*, 41: 304–305. doi:10.1093/jjco/hyr004 PMID:21273379
- Samkange-Zeeb F, Berg G, Blettner M (2004). Validation of self-reported cellular phone use. *J Expo Anal Environ Epidemiol*, 14: 245–248. doi:10.1038/sj.jea.7500321 PMID:15141153
- Saracci R & Samet J (2010). Commentary: Call me on my mobile phone...or better not?—a look at the INTERPHONE study results. *Int J Epidemiol*, 39: 695–698. doi:10.1093/ije/dyq082 PMID:20483832
- Sato Y, Akiba S, Kubo O, Yamaguchi N (2011). A case-case study of mobile phone use and acoustic neuroma risk in Japan. *Bioelectromagnetics*, 32: 85–93. doi:10.1002/bem.20616 PMID:21225885
- Schlehofer B, Schlaefer K, Blettner M *et al.*; INTERPHONE Study Group (2007). Environmental risk factors for sporadic acoustic neuroma (Interphone Study Group, Germany). *Eur J Cancer*, 43: 1741–1747. doi:10.1016/j.ejca.2007.05.008 PMID:17600696
- Schmiedel S, Brüggemeyer H, Philipp J *et al.* (2009). An evaluation of exposure metrics in an epidemiologic study on radio and television broadcast transmitters and the risk of childhood leukemia. *Bioelectromagnetics*, 30: 81–91. doi:10.1002/bem.20460 PMID:19025781
- Schoemaker MJ & Swerdlow AJ (2009). Risk of pituitary tumors in cellular phone users: a case-control study. *Epidemiology*, 20: 348–354. doi:10.1097/EDE.0b013e31819c7ba8 PMID:19279493
- Schoemaker MJ, Swerdlow AJ, Ahlbom A *et al.* (2005). Mobile phone use and risk of acoustic neuroma: results of the Interphone case-control study in five North European countries. *Br J Cancer*, 93: 842–848. doi:10.1038/sj.bjc.6602764 PMID:16136046
- Schüz J, Böhler E, Berg G *et al.* (2006a). Cellular phones, cordless phones, and the risks of glioma and meningioma (Interphone Study Group, Germany). *Am J Epidemiol*, 163: 512–520. doi:10.1093/aje/kwj068 PMID:16443797
- Schüz J, Böhler E, Schlehofer B *et al.* INTERPHONE Study Group, Germany (2006b). Radiofrequency electromagnetic fields emitted from base stations of DECT cordless phones and the risk of glioma and meningioma (INTERPHONE Study Group, Germany). *Radiat Res*, 166: 116–119. doi:10.1667/RR3581.1 PMID:16808597
- Schüz J, Elliott P, Auvinen A *et al.* (2011). An international prospective cohort study of mobile phone users and health (Cosmos): design considerations and enrolment. *Cancer Epidemiol*, 35: 37–43. doi:10.1016/j.canep.2010.08.001 PMID:20810339
- Schüz J, Jacobsen R, Olsen JH *et al.* (2006c). Cellular telephone use and cancer risk: update of a nationwide Danish cohort. *J Natl Cancer Inst*, 98: 1707–1713. doi:10.1093/jnci/djj464 PMID:17148772
- Selvin S, Schulman J, Merrill DW (1992). Distance and risk measures for the analysis of spatial data: a study of childhood cancers. *Soc Sci Med*, 34: 769–777. doi:10.1016/0277-9536(92)90364-V PMID:1604371
- Spinelli V, Chinot O, Cabaniols C *et al.* (2010). Occupational and environmental risk factors for brain cancer: a pilot case-control study in France. *Presse Med*, 39: e35–e44. doi:10.1016/j.lpm.2009.06.020 PMID:19962851
- Stang A, Anastassiou G, Ahrens W *et al.* (2001). The possible role of radiofrequency radiation in the development of uveal melanoma. *Epidemiology*, 12: 7–12. doi:10.1097/00001648-200101000-00003 PMID:11138823
- Stang A, Schmidt-Pokrzywniak A, Lash TL *et al.* (2009). Mobile phone use and risk of uveal melanoma: results of the risk factors for uveal melanoma case-control study. *J Natl Cancer Inst*, 101: 120–123. doi:10.1093/jnci/djn441 PMID:19141780
- Szmigielski S (1996). Cancer morbidity in subjects occupationally exposed to high frequency (radiofrequency and microwave) electromagnetic radiation. *Sci Total Environ*, 180: 9–17. doi:10.1016/0048-9697(95)04915-0 PMID:8717316
- Szmigielski S, Sobiczewska E, Kubacki R (2001). Carcinogenic potency of microwave radiation: overview of the problem and results of epidemiological studies on Polish military personnel. *European Journal of Oncology*, 6: 193–199.
- Takebayashi T, Akiba S, Kikuchi Y *et al.* (2006). Mobile phone use and acoustic neuroma risk in Japan. *Occup Environ Med*, 63: 802–807. doi:10.1136/oem.2006.028308 PMID:16912083
- Takebayashi T, Varsier N, Kikuchi Y *et al.* (2008). Mobile phone use, exposure to radiofrequency electromagnetic

- field, and brain tumour: a case-control study. *Br J Cancer*, 98: 652–659. doi:10.1038/sj.bjc.6604214 PMID:18256587
- Thomas TL, Stolley PD, Stemhagen A *et al.* (1987). Brain tumor mortality risk among men with electrical and electronics jobs: a case-control study. *J Natl Cancer Inst*, 79: 233–238. PMID:3474455
- Tynes T, Hannevik M, Andersen A *et al.* (1996). Incidence of breast cancer in Norwegian female radio and telegraph operators. *Cancer Causes Control*, 7: 197–204. doi:10.1007/BF00051295 PMID:8740732
- Viel JF, Clerc S, Barrera C *et al.* (2009). Residential exposure to radiofrequency fields from mobile phone base stations, and broadcast transmitters: a population-based survey with personal meter. *Occup Environ Med*, 66: 550–556. doi:10.1136/oem.2008.044180 PMID:19336431
- Vrijheid M, Armstrong BK, Bédard D *et al.* (2009a). Recall bias in the assessment of exposure to mobile phones. *J Expo Sci Environ Epidemiol*, 19: 369–381. doi:10.1038/jes.2008.27 PMID:18493271
- Vrijheid M, Cardis E, Armstrong BK *et al.*; INTERPHONE Study Group (2006b). Validation of short term recall of mobile phone use for the Interphone study. *Occup Environ Med*, 63:237–243. doi:10.1136/oem.2004.019281 PMID:16556742
- Vrijheid M, Deltour I, Krewski D *et al.* (2006a). The effects of recall errors and of selection bias in epidemiologic studies of mobile phone use and cancer risk. *J Expo Sci Environ Epidemiol*, 16: 371–384. doi:10.1038/sj.jes.7500509 PMID:16773122
- Vrijheid M, Richardson L, Armstrong BK *et al.* (2009b). Quantifying the impact of selection bias caused by nonparticipation in a case-control study of mobile phone use. *Ann Epidemiol*, 19: 33–41. doi:10.1016/j.annepidem.2008.10.006 PMID:19064187
- Wolf R & Wolf D (2004). Increased incidence of cancer near a cell-phone transmitter station. *International Journal of Cancer Prevention*, 1: 123–128.

3. CANCER IN EXPERIMENTAL ANIMALS

3.1 Studies of carcinogenicity

See [Table 3.1](#)

3.1.1 Mouse

Groups of 50 male and 50 female B6C3F₁ mice (age, 8–9 weeks) were sham-exposed or received whole-body exposure to GSM (Global System for Mobile communications)-modulated radiofrequency (RF) radiation at 902 MHz, or to DCS (Digital Cellular System)-modulated RF radiation at 1747 MHz, in a Ferris wheel/tube-restrained design for 2 hours per day, 5 days per week, for 24 months. Exposures were performed with a three-phase signal imitating “basic,” “talk” and “environment” GSM signals. Cage controls were run in parallel. The average specific absorption rate (SAR) for each signal phase (0, 0.4, 1.3, and 4.0 mW/g), organ-averaged SARs, and corresponding standard variations were calculated. No increases in tumour incidence at any site were observed in exposed mice compared with sham-exposed mice. Decreases in the incidence of liver adenoma were seen in males exposed to GSM at 4.0 mW/g and in males exposed to DCS at 4.0 mW/g ([Tillmann et al., 2007](#)).

3.1.2 Rat

Groups of 100 male Sprague-Dawley rats (age, 8 weeks) were sham-exposed or exposed to RF radiation as pulsed microwaves at 2450 MHz, at 800 pulses per second (pps) with a pulse

width of 10 μ s (range of SAR values: young rats, 0.4 mW/g; older rats, 0.15 mW/g) for 21.5 hours per day, 7 days per week, for 25 months. The exposure to microwaves had no statistically significant effect on survival (median survival time: sham-exposed rats, 663 days; exposed rats, 688 days) or body weight. No statistically significant increases in the incidence of any benign or malignant tumours were identified at any site in exposed rats compared with sham-exposed controls. An increased incidence of total malignant tumours (all sites) was observed in rats exposed to RF radiation compared with sham-exposed controls ([Chou et al., 1992](#)). [The Working Group considered this finding to be of limited biological significance, since it resulted from pooling of non-significant changes in tumour incidence in several sites.]

Groups of female Sprague-Dawley rats (age, 52–70 days) were sham-exposed or exposed to RF radiation as GSM at 900 MHz, with a pulse of 217 Hz, for more than 23 hours per day, 7 days per week, for up to 37 months. In the four experiments that were carried out, the number of rats per group was 12 in experiments 1 and 2, and 30 in experiments 3 and 4. Rats were group-housed with up to 12 rats per cage. Whole-body averaged SARs (wbSARs) during the studies ranged from 32.5–130 mW/kg in rats weighing 170–200 g, to 15–60 mW/kg in rats weighing ~400 g. In experiment 1, surviving rats were killed and necropsied at 770 days [26.7 months] (mortality, 33%), while in experiment 2, surviving rats were killed and

Table 3.1 Studies of carcinogenicity in experimental animals exposed to radiofrequency radiation

Species, strain (sex) Duration Reference	Dosing regimen Animals/group at start	Incidence of tumours			Significance	Comments
Mouse, C3H/HeA (F) 10.5 mo Szmigielski et al. (1982)	2 450 MHz MW far field: sham, 5 mW/cm ² (SAR, 2–3 mW/g), 15 mW/cm ² (SAR, 6–8 mW/g), confinement stress group, cage control 2 h/d, 6 d/wk 40/group	Power density (mW/cm ²)	Mammary-gland tumours	CDT ₅₀	* <i>P</i> < 0.01	Mammary-gland tumours detected only by palpation
			at 8 mo	at 10 mo		
		0 (sham)	3/40	14/40	322 d	
		5	18/40*	32/40*	261 d	
		15	26/40*	37/40*	219 d	
		Confined	16/40*	31/40*	255 d	
Mouse, <i>Eμ-Pim1</i> (F) 18 mo Repacholi et al. (1997)	900 MHz (217 Hz [pulse repetition, similar to GSM]; pulse width, 0.6 ms), sham SAR: 0.008–4.2 mW/g, 0.13–1.4 mW/g (average) 2 × 30 min/d, 7 d/wk 100/sham-exposed group, 101/RF radiation-exposed group	Lymphoma (sham, RF-EMF): 3/100, 6/101 (lymphoblastic) 19/100, 37/101 (non-lymphoblastic) 22/100, 43/101 (all)			<i>P</i> = 0.0002 (non-lymphoblastic lymphoma) <i>P</i> = 0.006 (all lymphomas)	No standardized assessment criteria were defined for deciding which mice would be selected for necropsy. Mice surviving the 18 mo of exposure or sham-exposure were discarded without necropsy.
Mouse, C3H/HeJ (F) 21 mo Toler et al. (1997)	435 MHz (420–450 MHz) RF radiation with pulse-wave (pulse width, 1.0 μs; pulse rate, 1.0 kHz), sham Incident power density of 1.0 mW/cm ² ; SAR, 0.32 mW/g 22 h/d, 7 d/wk 200/group	Mammary-gland adenocarcinoma: 77/193 (exposed), 74/190 (sham)			NS	Complete histopathology
Mouse, C3H/HeJ (F) 18 mo Frei et al. (1998a)	2 450 MHz MW (SAR, 0.3 mW/g), sham 20 h/d, 7 d/wk 100/group	Mammary-gland carcinoma: 44% (RF radiation), 52% (sham)			NS	Complete histopathology
Mouse, C3H/HeJ (F) 78 wk Frei et al. (1998b)	2 450-MHz MW (SAR: 1.0 mW/g), sham 20 h/d, 7 d/wk 100/group	Mammary-gland carcinoma: 38% (RF radiation), 30% (sham)			NS	Complete histopathology

Table 3.1 (continued)

Species, strain (sex) Duration Reference	Dosing regimen Animals/group at start	Incidence of tumours	Significance	Comments
Mouse, C3H/HeJ (F) 76 wk Jauchem et al. (2001)	UWB (rise time, 176 ps; fall time, 3.5 ns; pulse width, 1.9 ns; peak energy field, 40 kV/m; repetition rate, 1 kHz; SAR, 0.0098 mW/g), sham 2 min/wk, 12 wk 100/group	Mammary-gland carcinoma: 48/100 (UWB), 52/100 (sham)	NS	Complete histopathology
Mouse, <i>Eμ-Pim1</i> and wild-type (C57BL/6NTac) (F) 104 wk Utteridge et al. (2002)	GSM-modulated 898.4 MHz (pulse width, 0.6 ms); SAR, 0.25, 1.0, 2.0, 4.0 mW/g; sham, cage control 1 h/d, 5 d/wk 120/group (wild-type and <i>Eμ-Pim1</i>)	Number of tumour-bearing animals: <i>Lymphoblastic lymphoma</i> Sham-exposed control (wild-type, transgenic): 3, 15; SAR = 0.25: 0, 8*; SAR = 1: 2, 8; SAR = 2: 2, 9; SAR = 4: 0, 15; total: 7, 55 <i>Non-lymphoblastic lymphoma</i> Sham-exposed control (wild-type, transgenic): 35, 74; SAR = 0.25: 40, 80; SAR = 1: 35, 78; SAR = 2: 43, 84; SAR = 4: 36, 84; total: 189, 400 <i>Neurological tumours</i> Sham-exposed control (wild-type, transgenic): 11, 1; SAR = 0.25: 17, 4; SAR = 1: 15, 0; SAR = 2: 10, 2; SAR = 4: 9, 2; total: 62, 9	* <i>P</i> = 0.02 (decrease)	Restrained exposure (Ferris wheel) also for sham, but cage-control group unrestrained. Necropsy was performed on all mice.
Mouse, AKR/J (F) 40 wk Sommer et al. (2004)	GSM 900 MHz (overall max. SAR, 5.9 mW/g; average SAR, 0.4 mW/g [whole body]), sham 24 h/d, 7 d/wk 160/group	No increase in tumour incidence	NS	Histopathology was performed on spleen, thymus, lymph nodes, liver, kidney, lung and brain.
Mouse, <i>Eμ-Pim1</i> (M, F) 18 mo Oberto et al. (2007)	GSM-modulated 900 MHz (pulse width, 0.577 ms); SAR, 0.5, 1.4, 4.0 mW/g (whole body); sham, cage control 2 × 30 min/d, 7 d/wk 50 M and 50 F/group	Number of tumour-bearing animals: <i>Lymphoma</i> (all): (M) – 8 (cage), 9 (sham), 10 (0.5, 1.4 mW/g), 3 (4 mW/g); (F) – 26 (cage), 22 (sham), 18 (0.5 mW/g), 30 (1.4 mW/g), 20 (4.0 mW/g) <i>Harderian gland adenoma</i> : (M) – 0 (sham), 0 (0.5 mW/g), 2 (1.4 mW/g), 4 (4.0 mW/g)	Harderian-gland adenoma: <i>P</i> = 0.0028 (one-tailed test, trend) (M)	Restrained exposure (Ferris wheel). Mortality was higher (<i>P</i> < 0.05) in all three groups of exposed males and in the females exposed at 0.5 mW/g. GLP

Table 3.1 (continued)

Species, strain (sex) Duration Reference	Dosing regimen Animals/group at start	Incidence of tumours	Significance	Comments
Mouse, B6C3F ₁ (M, F) 24 mo Tillmann et al. (2007)	GSM 902 MHz, DCS 1 747 MHz, sham, cage control; wbSAR: 0.4, 1.3, 4 mW/g for each signal. 2 h/d, 5 d/wk 50 M and 50 F/group	<i>All tumours (%)</i> GSM (M/F):sham (68/78), low dose (62/78), medium dose (66/74), high dose (64/78); DCS (M/F): sham (74/74), low dose (60/62), medium dose (50/70), high dose (48/66) DCS: No. of males with tumours: 37 (sham), 30 (low dose), 25 (medium dose)* and 24 (high dose)*; No. of males with benign tumours: 27 (sham), 21 (low dose), 17 (medium dose), 12 (high dose)* <i>Liver adenoma in males (%)</i> DCS: 22 (sham), 4 (high dose)*; GSM: 30 (sham); 12 (high dose)*	* <i>P</i> < 0.05 (decrease)	Restrained exposure (Ferris wheel) Complete histopathology GLP
Mouse, <i>Ptc1</i> ^{+/-} , <i>Ptc1</i> ^{+/+} (wild-type) (M, F) Lifetime Saran et al. (2007)	GSM-modulated 900 MHz (wbSAR, 0.4 mW/g), sham, cage control 2 × 30 min/d, 5 d, starting on PND 2 23–26 heterozygous and 22–29 wild-type mice/sex/group	No increase in tumour incidence	NS	Histopathology was performed on brain, a 5 cm ² piece of skin, and any visible neoplasm.
Mouse, AKR/J (F) 43 wk Sommer et al. (2007)	UMTS (FDD, 1 966 MHz; SAR, 0.4 mW/g), sham, cage control 24 h/d, 7 d/wk 160/sham- or RF radiation-exposed group and 30/cage-control group	<i>Lymphoma</i> RF radiation: 141 (88.1%); sham: 149/150 (93.1%); cage control, 29/30 (96.7%)	NS	Histopathology was performed on spleen, thymus, lymph nodes, liver, kidney, lung and brain.
Mouse, AKR/J (M, F) 42 wk Lee et al. (2011)	CDMA 849 MHz and WCDMA 1950 MHz (combined) with SAR of 2 mW/g for CDMA and WCDMA [variation estimated: 1.59–2.52 mW/g], sham 45 min/d, 5 d/wk 40 M and 40 F/group	<i>Thymic lymphoma</i> Sham: M: 30/40 (75%); F: 32/40 (80%) Combined RF radiation: M: 31/40 (78%); F: 31/40 (78%)	NS	Exposure was performed in a reverberation chamber. Histopathology was performed on spleen, thymus, lymph nodes, liver, kidney, lung and brain.
Rat, Sprague-Dawley (M) 25 mo Chou et al. (1992)	2 450 MHz (800 pps; pulse width, 10 µs; pulse modulation, 8 Hz), sham; SAR: 0.15 (800 g bw) and 0.4 mW/g (200 g bw) 21.5 h/d, 7 d/wk 100/group	<i>Malignant neoplasms (all sites)</i> Sham, 5/100; exposed, 18/100 <i>Adrenal gland, pheochromocytoma</i> Sham, 1/100; exposed, 7/100 <i>Adrenal gland, cortical carcinoma</i> Sham, 0/100; exposed, 3/100	<i>P</i> = 0.005, χ^2 NS	Complete histopathology No increase in tumour incidence at any site.

Table 3.1 (continued)

Species, strain (sex) Duration Reference	Dosing regimen Animals/group at start	Incidence of tumours	Significance	Comments
Rat, F344 (M, F) 24 mo La Regina et al. (2003)	FDMA 835.6 MHz, CDMA 847.7 MHz, sham; SAR (brain): 0.85 ± 0.34 mW/g (time-averaged SAR), 1.3 ± 0.5 mW/g (nominal time-averaged brain SAR) 4 h/d, 5 d/wk 80 M and 80 F/group	<i>Total No. of tumours</i> (Sham/FDMA/CDMA): 76/79/78 (F), 163/162/148 (M) Mixed glioma (%): 0/1/0 (F) Astrocytoma (%): 0/0/1 (F), 0/1/0 (M) Granular cell tumour (%): 1/0/0 (F), 0/1/0 (M)	NS	Restrained exposure (Ferris wheel). Over the 2-yr time-course study, the brain SAR varied from 0.5 to 2.5 mW/g. Complete histopathology, 20–30 brain sections were examined per rat.
Rat, F344 (M, F) 24 mo Anderson et al. (2004)	1 620 MHz Dams and pups: far-field exposure from GD 19 until weaning (pups aged 23 days). Pups (age, 36 days): near-field exposure of ~2 yr. Brain SAR: 0.16 mW/g (fetuses, far field), 0.16 or 1.6 mW/g (offspring, near-field), sham, cage control. 2 h/d, 7 d/wk (far-field), 2 h/d, 5 d/wk (near field) 80–90 M and 80–90 F pups/group: near-field (2 groups), sham (1 group), cage control (1 group)	No increase in tumour incidence	NS	Restrained exposure (Ferris wheel) for near-field exposure Complete histopathology The incidence of brain neoplasms was within the range for historical controls
Rat, Wistar (M, F) 24 mo Smith et al. (2007)	902 MHz (GSM), 1 747 MHz (DCS), sham, cage control; time-averaged wbSAR: 0.44, 1.33, 4.0 mW/g for each signal. 2 h/d, 5 d/wk 50 M and 50 F/group	No increase in tumour incidence	NS	Restrained exposure (Ferris wheel) Due to increase in bw, the wbSAR of the group at the highest dose (4.0 mW/g targeted) was reduced to 3.0 mW/g after about 2 years; on average, a wbSAR of 3.7 mW/g was obtained; detailed SAR values and uncertainty were estimated for many organs. Complete histopathology GLP

bw, body weight; B[a]P, benzo[a]pyrene; CDMA, code-division multiple access; CDT₅₀, cancer-development time 50 (i.e. time in which 50% of the mice developed skin carcinoma); d, day; DCS, digital personal communications system; FDD, frequency-division duplexing; FDMA, frequency-division multiple access; GD, day of gestation; GLP, good laboratory practice; GSM, Global System for Mobile Communication; min, minute; mo, month; MW, microwave; NS, not significant; PND, postnatal day; RF-EMF, radiofrequency electromagnetic field; SAR, specific absorption rate; UWB, ultra-wide band; WCDMA, wide-band code division multiple access; wk, week; yr, year

necropsied at 580 days [19.3 months] (mortality, 50%). In experiment 1, histopathological evaluations were performed on the main organs, while only gross pathology was performed in experiment 2. In experiments 3 and 4, the rats were followed until natural death and histopathology was done on macroscopically detected changes only. In experiments 1 and 2, fewer pituitary tumours were detected in rats exposed to RF radiation (42% and 33% in experiments 1 and 2, respectively) than in sham-exposed controls (75% and 50% in experiments 1 and 2, respectively). Decreased incidences of mammary tumours (possibly associated with significantly shortened median survival times) were seen in experiments 3 and 4. No evidence of increased incidence of cancer in any tissue was reported in exposed rats compared with sham-exposed controls in any of the four experiments performed ([Bartsch et al., 2010](#)). [The Working Group considered that the value of these experiments was limited by the lack of reproducibility in survival times in experiments 1 and 2 (performed with identical protocols), by the small group sizes in all experiments, and by the poor reporting of tumour data from all experiments. Because complete pathology results were not reported, this study cannot be regarded as a comprehensive carcinogenicity bioassay, and it was not considered in the evaluation.]

Groups of 80 female and 80 male F344 rats (age, 6 weeks) were sham-exposed or exposed to RF radiation in the FDMA mode (frequency-division multiple access) 835.6 MHz, or in the CDMA mode (code-division multiple access) at 847.7 MHz, for 4 hours per day, 5 days per week, for 24 months. Rats were tube-restrained during exposure; time-averaged SAR in the brain was 1.3 mW/g for both signals. There were no significant differences in survival, body weight or tumour incidence at any site in exposed males or females when compared with sex-matched sham-exposed controls ([La Regina et al., 2003](#)).

Groups of pregnant Fischer 344 rats were exposed to far-field RF radiation at 1620 MHz

for 2 hours per day, 7 days per week, from day 19 of gestation until weaning. At age 36 days, groups of 90 male and 90 female offspring were sham-exposed or exposed in tubes to near-field RF radiation at 1620 MHz (head mostly) for 2 hours per day, 5 days per week, for 24 months. Sham-exposure and near-field exposure were performed using a Ferris wheel/tube-restrained design at two targeted levels (brain SAR, 0.16 and 1.6 mW/g). No statistically significant differences between exposed and control groups were observed in number of live pups per litter, survival index, or weaning weights. There were no statistically significant effects of exposure on mean body weight of surviving rats. The percentage of rats surviving at study termination did not differ among groups. Incidences of tumours were similar in all groups ([Anderson et al., 2004](#)).

Groups of 50 male and 50 female Wistar rats (age, approximately 6 weeks) were sham-exposed or received whole-body exposure to GSM-modulated RF radiation at 902 MHz, or to DCS-modulated RF radiation at 1747 MHz, in a Ferris wheel/tube-restrained design for 2 hours per day, 5 days per week, for 24 months. Exposures were performed with a three-phase signal imitating “basic,” “talk” and “environment.” Cage controls were run in parallel. Time-averaged wbSARs in the three exposure groups were 0.44, 1.33, and 4.0 mW/g for each signal phase. Body weight and survival were not statistically different between exposed and sham-exposed groups. No significant differences in the incidences of benign or malignant neoplasms at any site were observed between the exposed and sham-exposed groups ([Smith et al., 2007](#)).

3.1.3 Transgenic and tumour-prone models

(a) E μ -pim1 transgenic mouse

The E μ -Pim1 transgenic mouse strain has been reported to spontaneously develop lymphoma and to show an increased incidence of lymphoma

in response to exposure to chemical carcinogens ([Breuer et al., 1989](#); [van Kreijl et al., 1998](#)).

Groups of 100–101 female heterozygous *Eμ-Pim1* mice (age, 6–8 weeks) were sham-exposed or exposed to RF radiation as “GSM basic” at 900 MHz for up to 18 months. Mean SAR values in exposed mice were 0.13–1.4 mW/g. At study termination, mice that were clinically healthy were counted as survivors and discarded without further investigation. Exposure to RF radiation had no statistically significant effect on body weight [survival data were not reported]. The authors reported a twofold increase in the incidence of lymphoma in *Eμ-Pim1* mice exposed to GSM RF radiation ($P = 0.006$ versus the sham-exposed group) ([Repacholi et al., 1997](#)). [The Working Group considered the complete lack of pathology data to be a major limitation in the design of this study.]

Groups of 120 female heterozygous *Eμ-Pim1* mice and 120 female wild-type mice (C57BL/6NTac) (age, 7.5–9.5 weeks) were sham-exposed or exposed to GSM-modulated RF radiation at 898.4 MHz in a Ferris-wheel/restrained design at four different exposure levels (SAR: 0.25, 1.0, 2.0 or 4.0 mW/g) for 1 hour per day, 5 days per week, for 104 weeks. An unrestrained cage-control group was also included in the study. No significant differences in survival or body weight were observed between exposed and sham-exposed mice of either strain. Survival of the transgenic mice was significantly lower than that of wild-type mice ($P < 0.001$). No significant increases in the incidence of lymphoblastic or non-lymphoblastic lymphoma were seen in exposed mice compared with sham-exposed mice at any exposure level ([Utteridge et al., 2002](#)).

Groups of 50 male and 50 female *Eμ-Pim1* mice (age, 9 weeks) were sham-exposed or exposed to RF radiation as “GSM basic” phase signal at 900 MHz, with a pulse of 217 Hz, and pulse width of 0.5 ms, at wbSARs of 0, 0.5, 1.4, or 4.0 mW/g. Exposures were for 1 hour per day, split into two sessions of 30 minutes (morning and afternoon),

7 days per week, for up to 18 months. Cage controls were run in parallel. As in the study by [Utteridge et al. \(2002\)](#), the mice were restrained in tubes during exposure or sham exposure. Compared with sham-exposed mice, survival until termination of the study was shorter in male mice in all groups exposed to RF radiation and in female mice exposed at 0.5 mW/g. Compared with sham-exposed groups, there was no significant difference in the mean body weight of either females or males. No statistically significant differences were seen in the incidences of malignant lymphoma (lymphoblastic and non-lymphoblastic) in sham-exposed or exposed males or females. The incidences of tumours of the Harderian gland were significantly higher in male mice exposed to RF radiation than in controls, with a dose-dependent trend ($P = 0.0028$, one-tailed test); this resulted in a significant positive trend in the overall incidence of benign tumours ($P < 0.01$). For females, no dose-related trends related to exposure to RF radiation were seen in the overall incidence of benign or malignant tumours, or of tumours regardless of type ([Oberto et al., 2007](#)). [The Working Group noted that in the study of [Repacholi et al. \(1997\)](#), 22% of the sham-exposed female mice had lymphomas, whereas in this study, 44% of the sham-exposed and 52% of the cage-control female mice developed lymphomas. The incidence of lymphoma in the exposed group was 43% in the study of [Repacholi et al. \(1997\)](#), a value similar to that for the control groups in this study.]

(b) *Patched1*^{+/-} mouse

[Saran et al. \(2007\)](#) used newborn *Patched1* heterozygous knockout mice (*Ptc1*^{+/-}), a mouse model characterized by predisposition to tumours of the brain and other tissues, and by hypersensitivity to ionizing radiation. Groups of 23–36 male and 23–36 female *Ptc1*^{+/-} mice, and groups of 22–29 male and 22–29 female wild-type mice were exposed to RF radiation at 900 MHz (wbSAR, 4 mW/g) from postnatal days 2 to

6 (30 minutes, twice per day), the time window of extreme susceptibility to induction of medulloblastoma by ionizing radiation in this strain. Mice were monitored throughout their lifespan for the onset of brain tumours or any other visible neoplasm. No significant differences between exposed and sham-exposed groups were observed in the incidence or size of medulloblastoma, or in the incidence of any other neoplasms in either *Ptc1^{+/-}* mice or wild-type mice. [The Working Group noted that tumour data were not reported by sex. The very short duration of exposure, its timing during the immediate post-parturition period, and the lack of exposure of older juvenile or adult animals may limit the value of this study for hazard identification.]

(c) *AKR mouse*

The AKR mouse strain is known to develop lymphomas and other haematopoietic malignancies within the first year of life.

Groups of 160 unrestrained female AKR/J mice were sham-exposed or exposed to GSM-like RF radiation at 900 MHz for 24 hours per day, 7 days per week, for 40 weeks, at an average wBSAR of 0.4 mW/g. Exposure had a significant effect on body weight gain, with higher values in exposed than in sham-exposed mice. Survival and incidence of lymphoma did not differ between exposed and sham-exposed mice (Sommer *et al.*, 2004). [The Working Group noted that in the absence of any difference in survival, the ability of the study design to detect any effect on tumour incidence between groups was small.]

Groups of 160 female AKR/J mice (age, 8 weeks) were sham-exposed or exposed to RF radiation as Universal Mobile Telecommunications System (UMTS) at 1966 MHz (SAR, 0.4 mW/g) for 24 hours per day, for 248 days (43 weeks). The 30 mice in the cage-control group gained significantly less weight than did the exposed and sham-exposed animals. No statistically significant differences in total body weight, survival, or incidence of neoplasms were observed between

exposed and sham-exposed mice. The incidence of lymphoma in all three groups was above 88% (RF-radiation exposed, 88.1%; sham-exposed, 93.1%; and cage controls, 96.7%) (Sommer *et al.*, 2007). [The Working Group noted that in the absence of any difference in survival, the ability of the study design to detect any effect on tumour incidence between groups was small.]

Groups of 40 female and 40 male AKR/J mice (age, 5 weeks) were exposed simultaneously to RF radiation at 849 MHz (SAR, 2 mW/g) and 1950 MHz (SAR, 2 mW/g), for 45 minutes per day, 5 days per week, for 42 weeks. Sham exposures were performed in parallel. No differences in body weight, survival or tumour incidence were observed. The incidence of lymphomas in all groups was greater than 75% (Lee *et al.*, 2011). [The Working Group noted the short daily exposure period. Furthermore, in the absence of any difference in survival, the ability of the study design to detect any effect on tumour incidence between groups was small.]

(d) *C3H mouse*

The C3H tumour-prone mouse carries a milk-borne virus that induces tumours of the mammary gland.

Groups of 40 female C3H/HeA mice were exposed to RF radiation at 2450 MHz as continuous microwaves from ages 6 weeks to 12 months. Five experimental groups (SAR, 0 [sham-exposed control], 2–3 mW/g, or 6–8 mW/g, confinement-stress group, cage-control group) were used. Mammary-gland tumours were detected by palpation. A more rapid appearance of mammary-gland tumours and a statistically significant increase in the incidence of mammary-gland tumours in both groups of mice exposed to microwave radiation was reported, compared with controls (Szmigielski *et al.*, 1982). [The Working Group noted that no histopathology was performed.]

Groups of 200 female C3H/HeJ mice were sham-exposed or received whole-body exposure

to a horizontally polarized pulse wave at 435 MHz (pulse width, 1.0 ps; pulse rate, 1.0 kHz; wbSAR, 0.32 mW/g) for 22 hours per day, 7 days per week, for 21 months. No statistically significant differences in survival or body weight, or in the incidence, latency or growth rate of mammary-gland tumours were seen between exposed and sham-exposed groups ([Toler et al., 1997](#)).

Groups of 100 female C3H/HeJ mice (age, 3–4 weeks) were sham-exposed or exposed to continuous microwave radiation at 2450 MHz for 20 hours per day, 7 days per week, for 18 months. The average wbSAR was 0.3 mW/g. No significant differences in survival or body weight, or in the incidence, latency or growth rate of mammary-gland tumours were seen ([Frei et al., 1998a](#)).

A study with a similar design was performed at a higher SAR (1.0 mW/g). Groups of 100 female C3H/HeJ mice (age, 3–4 weeks) were sham-exposed or exposed to continuous microwave radiation at 2450 MHz, for 20 hours per day, 7 days per week, for 78 weeks. No differences in survival or body weight or in the incidence, latency or growth rate of mammary-gland tumours were observed ([Frei et al., 1998b](#)).

Groups of 100 female C3H/HeJ mice (age, 3–4 weeks) were exposed to pulses composed of an ultra-wide band (UWB) of frequencies with a rise time of 176 ps and a peak-energy field of 40 kV/m (SAR, 0.0098 mW/g). The mice were exposed for 2 minutes per week for 12 weeks, followed by a post-exposure period of 64 weeks. No significant differences between groups with respect to body weight, incidence of palpated mammary-gland tumours, latency to onset of mammary-gland tumour development, rate of mammary-gland tumour growth, or survival were found. Histopathological evaluations revealed no significant differences in tumour incidences between the two groups for all tissues studied ([Jauchem et al., 2001](#)). [The Working Group considered that the exposure was very limited.]

(e) *OF1 mouse*

The Ico:OF1 mouse strain is known to develop spontaneous tumours of the lymphoid tissue. Groups of 20 female mice were sham-exposed or exposed to RF radiation at 800 MHz for 1 hour per week, for 4 months, and followed for up to 18 months ([Anghileri et al., 2005](#)). Compared with controls, the exposure caused an earlier onset of general lymphocyte infiltration, formation of lymphoblastic ascites, and development of extranodal tumours of different histological types. [The Working Group considered that the inadequate description of the exposure level and dosimetry, the lack of histopathology, and the small group size did not permit a proper evaluation of this study.]

3.2 Initiation–promotion studies

See [Table 3.2](#)

The effect of exposure to RF radiation on tumours initiated by a chemical or physical carcinogen has been tested in various rodent models.

3.2.1 *Skin-tumour model*

Four groups of female ICR mice (age, 10 weeks) were given a single application of 100 µg of 7,12-dimethylbenz[*a*]anthracene (DMBA) on pre-shaved dorsal skin. Exposure to RF radiation started 1 week later and was continued for 19 weeks. Group 1 (48 mice) was exposed to a TDMA (time-division multiple access) signal at 1.49 GHz (50 pps, near-field), for 90 minutes per day, 5 days per week, at a skin local peak SAR of 2.0 mW/g. Group 2 (48 mice) was sham-exposed. Group 3 (30 mice) was exposed weekly and topically to 4.0 µg of 12-*O*-tetradecanoylphorbol-13-acetate (TPA) per mouse. Group 4 (30 mice) received no further treatment. The incidences of skin papilloma or carcinoma (combined) were 0 out of 48, 0 out of 48, 29 out of 30, and 1 out of 30, respectively ([Imaida et al., 2001](#)).

In a comparable experiment, groups of 20 male ICR mice (age, 7 weeks) received the same single skin application (100 µg of DMBA per mouse). Exposure to RF radiation started 1 week later and was continued for 19 weeks. Group 1 was exposed topically to 4 µg of TPA per mouse, twice per week. Group 2 was sham-exposed. Group 3 was exposed to RF radiation at 849 MHz (45 minutes, twice per day, with an interval of 15 minutes between exposures, for 5 days per week). Group 4 was exposed to RF radiation at 1763 MHz (with a schedule similar to that for group 3). A CDMA signal was used with a $wbSAR$ of 0.4 mW/g. Skin tumours [not further specified] were detected only in the DMBA/TPA-treated positive control group ([Huang et al., 2005](#)). [The Working Group noted the short duration of daily exposures and the use of only one exposure level per experiment.]

Groups of 10 male Swiss albino mice (age, 8 weeks) received a single skin application of 100 µg of DMBA (initiated groups) or were left untreated. Exposure to RF radiation or to croton oil (the positive control) started 2 weeks later. Group 1 was not initiated and was sham-exposed. Group 2 was exposed to DMBA only (cage control). Group 3 was exposed to DMBA plus amplitude-modulated (AM) RF radiation at 112 MHz, with a SAR of 0.75 mW/g, for 2 hours per day, 3 days per week, for 16 weeks. Group 4 was exposed to DMBA plus RF radiation at 2450 MHz with a SAR of 0.1 mW/g for 2 hours per day, 3 days per week, for 16 weeks. Group 5 was exposed to AM RF radiation at 112 MHz only. Group 6 was exposed to RF radiation at 2450 MHz only. Group 7 was exposed to DMBA plus a topical application of croton oil at 1% in 100 µL of acetone per mouse, twice per week, for 16 weeks. At study termination, skin tumours were detected only in the positive-control group (DMBA plus croton oil) ([Paulraj & Behari, 2011](#)). [The Working Group noted that the study was limited by the small group size and the relatively short duration of exposure.]

The promoting activity of RF radiation at 94 GHz was tested in groups of 27–55 female SENCAR mice previously initiated by dorsal application of DMBA at 10 nmol (2.56 µg). In a first experiment, 2 weeks after initiation, restrained mice were dorsally exposed once for 10 seconds to RF-EMF as follows: group 1 was exposed to millimetre wavelength (MMW) continuous wave far-field RF radiation (94 GHz, 1.0 W/cm²) and group 2 was exposed to infrared radiation at 1.5 W/cm². Both exposures led to similar skin heating (13–15 °C). Mice in group 3 were sham-exposed. In the positive-control group, initiated mice received the promoter TPA. After 23 weeks, the incidence and multiplicity of skin tumours was found to be similar in mice exposed to RF radiation, infrared radiation or sham-irradiated. TPA significantly increased both incidence and multiplicity of skin tumours compared with the other groups. [The Working Group noted that the importance of these findings was diminished by the very limited exposure to RF radiation.] In a second experiment, the effects of repeated exposure to RF radiation (333 mW/cm²) or infrared radiation (600 mW/cm²) for 10 seconds, twice per week, for 12 weeks, on skin-cancer promotion or co-promotion together with TPA were investigated. Groups of 50 female SENCAR mice were initiated with DMBA as above, and promotion treatment was started 2 weeks later. Group 1 was exposed to DMBA and sham-exposed; group 2 was exposed to DMBA + TPA and sham-exposed; group 3 was not initiated, exposed to TPA, and sham-exposed; group 4 was exposed to DMBA plus RF radiation at 333 mW/cm²; group 5 was exposed to DMBA plus RF radiation at 333 mW/cm² plus TPA; group 6 was exposed to DMBA plus infrared radiation at 600 mW/cm²; group 7 was exposed to DMBA plus infrared radiation at 600 mW/cm² plus TPA; and group 8 was sham-exposed only. The study was terminated 25 weeks after initiation. TPA promotion increased the incidence and multiplicity of skin tumours. Exposure to RF or infrared radiation did not

Table 3.2 Initiation–promotion studies in experimental animals exposed to radiofrequency radiation

Species, strain (sex) Tumour initiator Duration Reference	Dosing regimen Animals/group at start	Incidence of tumours	Significance	Comments
Mouse, CBA/S (F) X-ray ionizing radiation, 4–6 MV (4 Gy as three 1.33 Gy fractions at 1-wk intervals) on wk 1 78 wk Heikkinen et al. (2001)	902.5 MHz (continuous NMT900), SAR, 1.5 mW/g; 902.4 MHz (pulsed GSM, 217 Hz), SAR, 0.35 mW/g; sham; and cage controls Time averaged input power: 6.1 ± 0.8 W for continuous RF group and 1.3 ± 0.1 W for pulsed RF group 1.5 h/d, 5 d/wk, 78 wk 50/group	Lymphoma (cage, sham, NMT and GSM): 0/50, 12/50, 12/50, 10/50	NS	Restrained exposure Full histopathology
Mouse, ICR (F) DMBA (dermal): 100 µg/100 µL acetone/mouse on wk 1 20 wk Imaida et al. (2001)	1.49 GHz TDMA signal (50 pulses/s), near-field 90 min/d, 5 d/wk, 19 wk (on wk 2) SAR (skin): 2.0 mW/g, SAR (wb, av): 0.084 mW/g	Skin squamous cell papilloma or carcinoma (combined), tumour multiplicity Group 1: DMBA + RF-EMF (n = 48) 0/48, 0 Group 2: DMBA + sham (n = 48) 0/48, 0 Group 3: DMBA + TPA (n = 30) 29/30*, 18.8 ± 13.4* Group 4: DMBA + cage control (n = 30) 1/30, 0.1 ± 0.5	NS NS *P < 0.001 -	
Mouse, SENCAR (F) DMBA (dermal): 10 nmol/200 µL acetone on wk 1 Exp. 1 and Exp. 2: 25 wk Mason et al. (2001)	Exp. 1: 94 GHz MMW CW far-field or IR heating, single skin exposure of 10 s (on wk 3); TPA, 2 × /wk for 23 wk Group 1: DMBA + 1.0 W/cm ² MMW (n = 55) Group 2: DMBA + 1.5 W/cm ² IR for 10 s (n = 55) Group 3: DMBA + sham (n = 55) Group 4: DMBA + TPA (n = 27) Exp 2: MMW or IR, skin exposure of 10 s, 2 × /wk, 12 wk; TPA, 2 × /wk for 23 wk Group 1: DMBA + sham Group 2: DMBA + sham + TPA Group 3: sham + TPA Group 4: DMBA + 333 mW/cm ² MMW Group 5: DMBA + MMW + TPA Group 6: DMBA + 600 mW/cm ² IR Group 7: DMBA + IR + TPA Group 8: sham 50/group	Exp. 1: Comparable skin tumour incidence and multiplicity in sham-, MMW- or IR-exposed groups. TPA increased incidence and multiplicity of skin tumours. Exp. 2: TPA promotion led to increased incidence and multiplicity of DMBA-induced skin tumours; exposure to MMW or IR did not further increase the incidence or multiplicity of DMBA + sham or DMBA + TPA + sham-induced skin tumours.		No SAR given

Table 3.2 (continued)

Species, strain (sex) Tumour initiator Duration Reference	Dosing regimen Animals/group at start	Incidence of tumours	Significance	Comments
Mouse, ICR (M) DMBA (dermal): 100 µg/100 µL acetone/mouse on wk 1 20 wk Huang et al. (2005)	849 MHz CMDA signal or 1 763 MHz CMDA signal 2 × 45 min/d (15-minute interval between exposures), 5 d/wk, 19 wk (on wk 2) SAR (wb, av): 0.4 mW/g Group 1: DMBA + TPA Group 2: DMBA + sham Group 3: DMBA + 849 MHz Group 4: DMBA + 1 763 MHz 20/group	No skin tumours in RF-EMF-exposed groups. Skin tumours (95%) in DMBA + TPA group only.	NS	Free-moving mice were exposed in a reverberation chamber. The short duration of daily RF-EMF-exposure is questionable.
Mouse, Swiss (M) DMBA (dermal): 100 µg on wk 1 18 wk Paulraj & Behari (2011)	112 MHz, AM at 16 Hz (1.0 mW/cm ² ; SAR, 0.75 mW/g) or 2 450 MHz (0.34 mW/cm ² ; SAR, 0.1 mW/g) 2 h/d, 3 d/wk, 16 wk (on wk 3) Group 1: control Group 2: DMBA Group 3: DMBA + 112 MHz Group 4: DMBA + 2 450 MHz Group 5: 112 MHz Group 6: 2 450 MHz Group 7: DMBA + croton oil 18/group	No skin tumours in any group, except in group 7		Small group size and short duration of exposure
Rat, F344 (M, F) ENU <i>in utero</i> , 4 mg/kg bw iv on GD 18 24 mo Adey et al. (1999)	836.55 MHz, NADC-modulated Far-field: GD 19–PND 21 (weaning) 2 h/d, 7 d/wk Near-field: starting on PND 33/35 2 h/d (8 × 7.5 min field on/off), 4 d/wk, 22 months SAR (brain): 1.1–1.6 mW/g SAR (wb, av): 1.8–2.3 mW/g	CNS tumours Total [%] Brain [%]		Ferris wheel/restrained exposure 25 (M) or 20 (F) sections per brain
	Group 1: sham/sham, <i>n</i> = 30 M + 30 F	11.7	8.3	-
	Group 2: sham/RF, <i>n</i> = 30 M + 30 F	3.3	3.3	NS
	Group 3: ENU/sham, <i>n</i> = 30 M + 30 F	16.7	15.0	-
	Group 4: ENU/RF, <i>n</i> = 30 M + 26 F	7.1	3.6	NS

Table 3.2 (continued)

Species, strain (sex) Tumour initiator Duration Reference	Dosing regimen Animals/group at start	Incidence of tumours	Significance	Comments	
Rat, Sprague-Dawley (F) B[a]P, 2 mg s.c. 160 d Chagnaud et al. (1999)	900 MHz, GSM-modulated, far-field (55 or 200 µW/cm ²)	Small palpable tumours (sarcomas) detectable from d 90–100 onwards.		Poor and confusing description of experiment and results. The authors stated that tumour onset was “slightly different” (<i>P</i> = 0.05) in the sham-exposed group and one of the exposed groups (55 µW/cm ² , 40 days).	
	SAR (wb, av): 75 or 270 mW/kg Exposure started on d 20, 40 or 75 after B[a]P initiation 2 h/d, 5 d/wk, 2 wk	Tumour incidence not reported. No consistent pattern of differences in time to tumour or survival.	NS		
	Group	RF (µW/cm ²)	No. of rats (sham/RF)		No. of days after B[a]P initiation
	1, 2	55	17/17		20
	3, 4	55	18/18		40
	5, 6	55	14/17		75
7, 8	200	8/9	40		
9	cage control	6	-		
Rat, F344 (M, F) ENU <i>in utero</i> , 4 mg/kg bw i.v. on GD 18 24 mo Adey et al. (2000)	836.55 MHz, NADC-modulated			Ferris wheel/restrained exposure 25 (M) or 20 (F) sections per brain	
	Far-field: GD 19–PND 21 (weaning) 2.6 ± 0.50 mW/cm ²				
	Near-field: PND 31–731/734 2 h/d (8 × 7.5 min field on/off), 4 d/wk				
	SAR (brain): 1.1–1.6 mW/g SAR (wb, av): 1.8–2.3 mW/g				
		Primary CNS tumours			
		Total [%]	Brain [%]		
	Group 1: sham/sham, <i>n</i> = 45 M + 45 F	1.1	1.1		-
	Group 2: sham/RF, <i>n</i> = 45 M + 45 F	4.4	3.3		NS
	Group 3: ENU/sham, <i>n</i> = 45 M + 45 F	22.2	18.9		-
	Group 4: ENU/RF, <i>n</i> = 38 M + 52 F	17.8	15.6		NS
Group 5: ENU/cage control, <i>n</i> = 45 M + 45 F	14.4	14.4			
Group 6: cage control, <i>n</i> = 45 M + 45 F	4.4	3.3			

Table 3.2 (continued)

Species, strain (sex) Tumour initiator Duration Reference	Dosing regimen Animals/group at start	Incidence of tumours	Significance	Comments						
Rat, Sprague-Dawley (M, F) ENU <i>in utero</i> , on GD 15, 0, 2.5 or 10 mg/kg bw i.v. 24 mo Zook & Simmens (2001)	860 MHz, PW or CW, near-field 6 h/d, 5 d/wk, 22 months (starting on PND 57)	No evidence that PW or CW increased the incidence of tumours in any studied tissues or promoted cranial or spinal or spinal nerve-cord tumours initiated by ENU.	NS (overall)	Restrained exposure of the head in tube (Ferris wheel) GLP Tissues studied histologically included brain (18–26 step sections [1 mm]/brain), spinal cord, trigeminal nerves, lungs, liver, heart, kidneys, spleen, adrenal, pituitary and thyroid glands, and any gross lesions, including all neoplasms.						
	SAR (brain, av): 1.0 ± 0.2 mW/g SAR (wb, av): 0.27–0.42 mW/g	No. of rats with brain tumours (M + F combined)								
	15 groups, 30 M + 30 F/group	All	Multiple		Astrocytoma	Oligodendroglioma	Mixed glioma			
	Group	ENU (mg/kg bw)	RF							
	1	0	PW		5	0	5	0	0	NS
	2	0	Sham		3	0	3	0	0	-
	9	0	CW		3	0	2	1	0	NS
	10	0	Sham		5	0	5	0	0	-
	13	0	Cage control		6	0	5	1	0	
	5	2.5	PW		7	2	4	2	4	NS
	6	2.5	Sham		9	1	3	2	5	-
	7	2.5	CW		9	0	2	6	1	NS
	8	2.5	Sham		10	1	5	5	1	-
	11	2.5	CW		3	0	0	0	3	NS
	12	2.5	Sham		6	0	3	1	3	-
14	2.5	Cage control	5	0	0	4	0			
3	10.0	PW	36	15	0	26	32	NS		
4	10.0	Sham	35	12	3	19	26	-		
15	10.0	Cage control	41	9	2	24	25			
Rat, Sprague-Dawley (F) DMBA, 50 mg/kg bw by gavage 259–334 d Bartsch et al. (2002)	900 MHz GSM signal (217 Hz pulsed; pulse width, 577 µs) Far-field, 100 µW/cm ² ± 3 dB; SAR (wb, av), 17.5–70 mW/kg 23 h/d, 7 d/wk Two groups each in three similar experiments performed over 3 years, 60/group	Mammary-gland tumours	Median tumour latency (d)		Cumulative incidence of tumours					
			Malignant	Benign	Last day of observation		[%]			
					Malignant	Benign	Malignant	Benign		
			145	316	334	79	90	-	-	
			278	310	334	82	91	<i>P</i> = 0.009 (retardation)	NS	
			95	> 265	259	84	38	-	-	
			95	221	259	94	60	NS	NS	
			216	293	343	91	89	-	-	
			195	321	343	81	92	NS	NS	
									Malignant tumours were adenocarcinomas	

Table 3.2 (continued)

Species, strain (sex) Tumour initiator Duration Reference	Dosing regimen Animals/group at start	Incidence of tumours	Significance	Comments					
Rat, Sprague-Dawley (M, F) ENU <i>in utero</i> , on GD 15, at 6.25 or 10 mg/kg bw i.v. Up to 24 months Zook & Simmens (2002, 2006)	860 MHz PW signal (frame rate, 11.1Hz; slot duration, 15-ms), near-field 6 h/d, 5 d/wk, up to 22 months (starting on PND 52) SAR (brain, av): 1.0 ± 0.2 mW/g SAR (wb, av): 0.27–0.42 mW/g 6 groups, 90 M + 90 F/group Group 1: ENU at 6.25 mg/kg bw + sham Group 2: ENU at 6.25 mg/kg bw + PW Group 3: 6.25 mg/kg bw ENU + cage control Group 4: 10.0 mg/kg bw ENU + sham Group 5: 10.0 mg/kg bw ENU + PW Group 6: 10.0 mg/kg bw ENU + cage control	Neurogenic tumours: PW does not affect incidence, multiplicity or latency.		Restrained exposure of the rat head in tube (Ferris wheel) GLP Study conducted in three phases. Each group included three cohorts of 30 M + 30 F. Euthanasia with 30-days intervals started on PND 171. Tissues that were studied histologically included brain (1-mm step sections), spinal cord, thyroid, pituitary and adrenal glands, liver, kidneys, lungs, spleen, heart, trigeminal nerves and any other tissues that appeared abnormal. The incidence, volume and malignancy grade of neurogenic tumours were increased in the group given ENU at 10 mg/kg bw compared with the group given ENU at 6.25 mg/kg bw. The incidences of tumours outside the nervous system were not associated with ENU treatment and were not increased in PW-exposed rats.					
		Brain tumours (No. of tumour-bearing rats) [6.25 and 10.0 mg/kg bw ENU-treated groups combined, M + F combined]:							
		<i>All</i>	<i>Multiple</i>		<i>Astrocytoma</i>	<i>Oligodendroglioma</i>	<i>Mixed glioma</i>		
		PW (360 animals at start)	173		61	1	111	100	NS
		Sham (360 animals at start)	193		76	5	118	113	-
		Cage control (360 animals at start)	180		58	6	106	107	-
Rat, Sprague-Dawley (F) DMBA, 10 mg/rat by gavage on d 1 10 d + 9 wk (RF exposure) + 3 wk Anane et al. (2003)	900 MHz, GSM, far-field <i>Exp. 1:</i> SAR (wb, av): 0 (sham), 1.4, 2.2, 3.5 mW/g <i>Exp. 2:</i> SAR (wb, av): 0 (sham), 0.1, 0.7, 1.4 mW/g 2 h/d, 5 d/wk, 9 wk 16/group in both experiments	Mammary-gland tumours							
		Rate of incidence of malignant tumours:							
		<i>Exp. 1:</i> groups exposed at 1.4 and 2.2 mW/g vs sham					<i>P</i> = 0.02, 0.04 (increase in rate of incidence)		
		<i>Exp. 2:</i> group exposed at 1.4 mW/g vs sham					<i>P</i> = 0.04 (decrease in rate of incidence)		
		<i>No. of tumours at wk 12</i>			<i>No. of rats without tumour</i>	<i>No. of rats alive at wk 12</i>			
		<i>Malignant</i>		<i>Benign</i>					
		<i>Exp. 1:</i> Sham	21	5	5	16	-		
		1.4 mW/g	24	5	2	16	NS		
		2.2 mW/g	24	2	1	16	NS		
		3.5 mW/g	29	6	2	15	NS		
<i>Exp. 2:</i> Sham	17	5	3	14	-				
0.1 mW/g	8	11	0	14	NS				
0.7 mW/g	13	15	4	16	NS				
1.4 mW/g	4	4	9	16	NS				

Table 3.2 (continued)

Species, strain (sex) Tumour initiator Duration Reference	Dosing regimen Animals/group at start	Incidence of tumours				Significance	Comments
Rat, F344 (M, F) ENU <i>in utero</i> , 4 mg/kg bw i.v. on GD 18 24 mo Shirai et al. (2005)	1 439 MHz TDMA signal (near-field) 90 min/d, 5 d/wk, wk 5–109 (offspring) SAR (brain): 0.67, 2.0 mW/g SAR (wb, av): < 0.4 mW/g	Pituitary tumours lower in ENU/high group				$P < 0.01$	Tube exposure/restrained Full histopathology ~10 sections/brain
		CNS tumours [%]					
		Brain		Spinal cord			
		M/F		M/F			
		Group 1: cage control		0/0			
		Group 2: ENU control		18/18			
		Group 3: ENU/sham		24/30		-	
Group 4: ENU/low (0.67 mW/g)		30/18		NS			
Group 5: ENU/high (2.0 mW/g)		22/16		NS			
50 M + 50 F/group							
Rat, Sprague-Dawley (F) DMBA, 35 mg/kg bw by gavage on d 1 26 wk Yu et al. (2006)	900 MHz GSM; SAR (wb, av): 0.44, 1.33, 4.0 mW/g 4 h/d, 5 d/wk, 26 wk (starting on d 2)	No significant differences in incidence, latency, multiplicity or size of mammary-gland tumours between sham- and RF-exposed groups					
		Mammary-gland tumours (all) (%)	Mammary-gland adenocarcinoma (%)	Benign mammary-gland tumours (%)	Mammary-gland hyperplasia (%)		
		Group 1: cage control	60*	37	23*	14	* $P < 0.05$ vs sham
		Group 2: sham	45	37	8	29	
		Group 3: 0.44 mW/g	38	25**	13	24	** $P = 0.058$ vs sham
		Group 4: 1.33 mW/g	41	34	7	15	
		Group 5: 4.0 mW/g	43	38	5	24	
99–100/group							
Rat, F344 (M, F) ENU <i>in utero</i> , 4 mg/kg bw i.v. on GD 18 24 mo Shirai et al. (2007)	1.95 GHz WCDMA signals for IMT-2000 cellular system (near-field) 90 min/d, 5 d/wk, wk 5–109 (offspring) SAR (brain): 0.67, 2.0 mW/g SAR (wb, av): ≤ 0.464 mW/g	Skin fibroma and large granular lymphocytic leukaemia incidences lower in ENU/high group				$P < 0.05$	Tube exposure/restrained Full histopathology ~10 sections/brain
		CNS tumours [%]					
		Brain		Spinal cord			
		M/F		M/F			
		Group 1: cage control		2/2			
		Group 2: ENU/cage control		16/14		-	
		Group 3: ENU/sham		8/10		NS	
Group 4: ENU/low (0.67 mW/g)		16/10		NS			
Group 5: ENU/high (2.0 mW/g)		16/22		NS			
5 M + 50 F/group							

Table 3.2 (continued)

Species, strain (sex) Tumour initiator Duration Reference	Dosing regimen Animals/group at start	Incidence of tumours				Significance	Comments
Rat, Sprague-Dawley (F) DMBA, 17 mg/kg bw by gavage on d 1 6 mo Hruby et al. (2008)	902 MHz GSM (crest factor of 8; pulse width, 0.57 ms); SAR (wb, av), 0.4, 1.3, 4.0 mW/g 4 h/d, 5 d/wk, 6 mo (starting on d 2) 100/group	Mammary-gland tumour multiplicity or volume Mammary-gland lesions (%)				NS (RF-exposed vs sham-exposed)	Restrained exposure in tube (Ferris wheel) GLP Malignant tumours were mainly adenocarcinomas.
		Malignant or benign	Malignant	Benign	Hyperplasia		
	Group 1: cage control	73	45	28	12		
	Group 2: sham	60	30	30	11		
	Group 3: 0.4 mW/g	57	40	17*	19	* $P < 0.05$ vs sham (decrease)	
	Group 4: 1.3 mW/g	50	35	15*	22		
	Group 5: 4.0 mW/g	65	47**	18*	9	** $P < 0.05$ vs sham (increase)	

B[a]P, benzo[a]pyrene; CDMA, code-division multiple access; CNS, central nervous system; CWRF, continuous-wave radiofrequency; d, day or days; DCS, Digital Personal Communication System; DEN, diethylnitrosamine; DMH, dimethylhydrazine; DMBA, 7,12-dimethylbenz[a]anthracene; EMF, electromagnetic field; ENU, *N*-ethyl-*N*-nitrosourea; FDMA, frequency-division multiple access; GD, gestational day; GSM, Global System for Mobile communication; h, hour; i.v., intravenously; IR, infrared radiation; min, minute; MMW, millimetre wavelength; mo, month; NADC, North American Digital Cellular; NS, not significant; ODC, ornithine decarboxylase; PH, partial hepatectomy; PND, postnatal day; p.o., oral administration; PW, pulse-modulated radiofrequency; RF, radiofrequency radiation; s, second; SAR (wb, av), (time-averaged whole-body) specific absorption rate; s.c., subcutaneously; TDMA, time-division multiple access; TPA, 12-*O*-tetradecanoylphorbol-13-acetate; UMTS, Universal Mobile Telecommunication System; UWB, ultra-wide band; WCDMA, wide-band code-division multiple access; wk, week

increase tumour incidence or multiplicity when compared with DMBA-treated sham-exposed controls. Exposure to TPA and RF radiation or TPA and infrared radiation did not increase the incidence of tumours or tumour multiplicity when compared with TPA controls. The authors concluded that MMW did not promote or co-promote skin tumorigenesis ([Mason et al., 2001](#)).

Starting at 20, 40, or 75 days after treatment with a single subcutaneous dose of 2 mg of benzo[*a*]pyrene, groups of 8–18 female Sprague-Dawley rats were exposed to GSM RF radiation at a wbSAR of 75 mW/kg for 2 hours per day, 5 days per week, for 2 weeks. An additional group was exposed to the GSM signal at a wbSAR of 270 mW/kg starting 40 days after the treatment with benzo[*a*]pyrene. For each GSM-exposed group, a sham-exposure group was included, resulting in a total of eight groups. The study was terminated at approximately 160 days after the treatment with benzo[*a*]pyrene. Small palpable tumours (sarcomas) were detectable from days 90 to 100. No consistent pattern of differences in time to tumour development or survival was observed between groups ([Chagnaud et al., 1999](#)). [The Working Group noted that the value of this study was diminished by the very limited exposure, the small group sizes, and the absence of histopathology.]

3.2.2 Lymphoma model

CBA/S mice are prone to develop lymphomas after exposure to ionizing radiation. In this study, groups of 50 female CBA/S mice (age, 3–5 weeks) (except the cage-control group) received whole-body exposure to ionizing radiation (X-rays, 4–6 MV, 4 Gy, delivered as three equal fractions of 1.33 Gy at intervals of 1 week) at the beginning of the study, followed by exposure to RF radiation for 1.5 hours per day, 5 days per week, for 78 weeks. A first “X-ray plus RF” group was exposed to continuous NMT900 (Nordic Mobile Telephony

900)-type frequency-modulated RF radiation at a frequency of 902.5 MHz and a nominal average SAR of 1.5 mW/g. A second “X-ray plus RF” group was exposed to pulsed GSM-type RF radiation (carrier-wave frequency, 902.4 MHz; pulse frequency, 217 Hz) at a nominal average SAR of 0.35 mW/g. An X-ray-exposed control group received sham exposure to RF radiation. Exposure to RF radiation did not significantly increase the incidence of tumours compared with the sham-exposed group ([Heikkinen et al., 2001](#)).

3.2.3 Mammary-gland tumour model

Groups of 60 female Sprague-Dawley rats (Hsd:SD) (age, 51 days) were given DMBA as a single intragastric dose of 50 mg/kg bw. On the same day, the rats were sham-exposed or exposed to RF radiation as a GSM signal at 900 MHz (pulse, 217 Hz) for 23 hours per day, 7 days per week, for 259–334 days. Over 3 years, three identical experiments with group-housed rats were performed. At the beginning of each experiment, wbSARs ranged from 32.5 to 130 mW/kg; wbSARs at 11 months ranged from 15 to 60 mW/kg; on average, wbSARs ranged from 17.5 to 70 mW/kg. Rats were killed when mammary-gland tumours reached 1–2 cm in diameter, and tumours were evaluated histopathologically. The incidence of benign or malignant mammary-gland tumours did not differ between sham-exposed and exposed groups. A statistically significant delay in the appearance of mammary-gland adenocarcinoma was seen in RF-exposed rats in the first experiment; this effect was not confirmed in the second or third experiment ([Bartsch et al., 2002](#)). [The Working Group noted the lack of reproducibility in tumour response between the three experiments.]

Two experiments were performed with the same GSM signal at 900 MHz as mentioned above, but with different intensities. In both experiments, groups of 16 female Sprague-Dawley rats were

sham-exposed or exposed to GSM RF radiation for 9 weeks, starting 10 days after administration by gastric intubation of 10 mg of DMBA at the age of 55 days, and were observed for an additional 3 weeks. In the first experiment, groups were exposed at wbSAR 0 (sham), 1.4, 2.2, or 3.5 mW/g and the authors reported that mammary-gland tumours developed more rapidly in rats exposed to signals at wbSAR 1.4 and 2.2 mW/g compared with controls. In the second experiment, groups were exposed at wbSAR 0 (sham), 0.1, 0.7, or 1.4 mW/g, and a decreased incidence of malignant mammary-gland tumours was seen in the group exposed to the signal at a wbSAR of 1.4 mW/g. Overall, no differences in the latency, multiplicity, or volume of mammary-gland tumours were observed ([Anane et al., 2003](#)). [The Working Group noted that the value of this study was reduced by the lack of reproducibility between exposure to RF radiation and mammary-gland tumour responses.]

Groups of 99–100 female Sprague-Dawley rats (age, 48 days) were given DMBA as a single oral dose of 35 mg/kg bw, followed by sham-exposure or exposure to RF radiation as a GSM signal at 900 MHz, for 4 hours per day, 5 days per week, for 26 weeks, in a Ferris wheel/tube-restrained system. Values for wbSAR were 0 (sham), 0.44, 1.33, and 4.0 mW/g. A cage-control group was also included. No differences in body weight, or in the incidence, latency to onset, multiplicity, or size of mammary-gland tumours were seen in this study ([Yu et al., 2006](#)).

In an experiment with a design very similar to that of [Yu et al. \(2006\)](#), groups of 100 female Sprague-Dawley rats (age, 46–48 days) were given DMBA as a single oral dose of 17 mg/kg bw, followed 1–2 days later by sham-exposure or exposure to RF radiation as a GSM signal at 900 MHz (pulse, 217 Hz), for 4 hours per day, 5 days per week, for 6 months, in a Ferris wheel/tube-restrained system. Values for wbSAR were 0 (sham), 0.4, 1.3, and 4.0 mW/g. A cage-control group was also included. Exposure to RF radiation

had no effect on survival or body weight. When compared with the sham-exposed control group, the group at 4.0 mW/g demonstrated a statistically significant increase in the number of rats with malignant mammary-gland tumours (mainly adenocarcinomas) and a significant decrease in the number of rats with benign mammary-gland tumours ([Hruby et al., 2008](#)). [The Working Group noted that incidences of mammary-gland cancer were similar in the group at 4.0 mW/g and in the cage-control group.]

3.2.4 Brain-tumour model

Groups of pregnant F344 rats received *N*-ethyl-*N*-nitrosourea (ENU) as a single intravenous dose at 4 mg/kg bw on day 18 of gestation. From day 19 of gestation to postnatal day 21, the pregnant dams and offspring were exposed to far-field RF radiation as an NDAC (North American Digital Cellular)-modulated signal at 836.55 MHz for 2 hours per day, 7 days per week. On postnatal day 33/35, the offspring were sham-exposed or exposed to intermittent near-field RF radiation, 2 hours (8 × 7.5 minutes field on/off) per day, 4 days per week. The total duration of the near-field plus far-field exposure was 24 months. The head region of each rat was exposed to near-field RF radiation in a Ferris wheel/tube-restrained system. Calculated SAR values in the brain ranged from 1.1–1.6 mW/g. The study included four groups: group 1 was sham-exposed (30 males, 30 females); group 2 was exposed to RF radiation (30 males, 30 females); group 3 was ENU/sham-exposed (30 males, 30 females); and group 4 was ENU/RF-exposed (30 males, 26 females). No statistically significant differences in the incidence of tumours of the brain or spinal cord were observed in the sham-exposed and RF-exposed groups ([Adey et al., 1999](#)).

The same laboratory performed a second study with a similar design in pregnant F344 rats exposed to ENU, the offspring of which then became treatment cohorts in six groups. Group

1 was sham-exposed (45 males and 45 females per group); group 2 was RF-exposed (45 males and 45 females per group); group 3 was ENU/sham-exposed (45 males and 45 females per group); group 4 was ENU/RF-exposed (38 males, 52 females); group 5 was exposed to ENU and served as cage control (45 males and 45 females per group); and group 6 served as cage control (45 males and 45 females per group). Treatment with ENU on day 18 of gestation and exposure to far-field RF radiation ($2.6 \pm 0.50 \text{ W/cm}^2$) from day 19 of gestation to postnatal day 21 was identical to that described in [Adey et al. \(1999\)](#). Sham exposure or exposure to near-field RF radiation (836.55 MHz, “balanced speech” modulation; brain SAR, 1.1–1.6 mW/g) for 2 hours per day, 4 days per week, began on postnatal day 31. The total duration of the near-field plus far-field exposure was 24 months. No statistically significant differences were identified in the incidence or histological type of tumours of the brain and spinal cord in the RF-exposed and sham-exposed groups ([Adey et al., 2000](#)).

Pregnant F344 rats received ENU as a single intravenous dose at 4 mg/kg bw on day 18 of gestation. Offspring were randomized into groups of 50 males and 50 females as follows: group 1 was a cage-control group; group 2 was exposed to ENU only; group 3 was exposed to ENU and sham-exposed to RF radiation; group 4 was exposed to ENU and exposed to RF radiation at a low level (brain averaged SAR, 0.67 mW/g); and group 5 was exposed to ENU and exposed to RF radiation at a high level (brain averaged SAR, 2.0 mW/g). Offspring received “head-only” exposure to near-field RF radiation (1439 MHz, TDMA signal), 90 minutes per day, 5 days per week, until age 104 weeks. Exposure to TDMA-modulated RF radiation had no effect on the survival or body weight of rats treated with ENU. Comparisons of the incidences of tumours of the brain and spinal cord in rats treated with ENU did not reveal any statistically significant effects

of exposure to TDMA RF radiation ([Shirai et al., 2005](#)).

A second study was performed by the same laboratory, with a design that was essentially identical to that described in [Shirai et al. \(2005\)](#). Pregnant F344 rats received ENU as a single intravenous dose at 4 mg/kg bw on day 18 of gestation. Offspring were randomized into groups of 50 males and 50 females as follows: group 1 was a cage-control group; group 2 was exposed to ENU only; group 3 was exposed to ENU and sham-exposed; group 4 was exposed to ENU and exposed to RF radiation at a low level (brain averaged SAR, 0.67 mW/g); and group 5 was exposed to ENU and exposed to RF radiation at a high level (brain averaged SAR, 2.0 mW/g). Offspring received “head-only” exposure to near-field RF radiation as a WCDMA (wide-band code-division multiple access) signal at 1.95 GHz from cell phones for IMT-2000 (International Mobile Telecommunication) cellular systems, for 90 minutes per day, 5 days per week, until age 104 weeks. Exposure to RF radiation had no effect on the survival or body weight of rats treated with ENU. Comparisons of the incidences of tumours of the brain and spinal cord in rats treated with ENU did not reveal any statistically significant effects of exposure to WCDMA RF radiation ([Shirai et al., 2007](#)).

Pregnant Sprague-Dawley rats received ENU by intravenous injection at a dose of 0, 2.5 or 10 mg/kg bw on day 15 of gestation. Beginning on postnatal day 57, groups of offspring were sham-exposed or exposed to RF radiation in a Ferris wheel/tube-restrained system for 6 hours per day, 4 days per week for 22 months. RF metrics tested included a pulsed-wave signal (PW) at 860 MHz and a continuous-wave signal (CW) at 860 MHz. Average brain SAR was 1.0 mW/g for both. Including cage controls, the entire experiment consisted of 15 groups of 30 males and 30 females. Key groups included ENU plus sham-exposure; ENU plus PW exposure; and ENU plus CW exposure. Detailed data regarding

treatment and tumour incidences are tabulated in [Table 3.2](#). The results of this study provided no statistically significant evidence that exposure to PW or to CW increased the incidence of tumours in any of the tissues studied, or that it promoted the induction of cranial or spinal-cord tumours initiated by ENU ([Zook & Simmens, 2001](#)).

In a follow-up study by the same authors, pregnant female Sprague-Dawley rats received ENU as a single intravenous dose at 6.25 or 10.0 mg/kg bw on day 15 of gestation. Offspring were randomized by ENU-dose into groups of 90 males and 90 females and then, as in the previous study, exposed to RF radiation from postnatal day 52 ± 3 as a PW signal at 860 MHz, in a Ferris wheel/tube-restrained system, 6 hours per day, 5 days per week, at an average brain SAR of 1.0 mW/g. The study was terminated when the offspring were aged 24 months. Each group included three cohorts and the study was conducted in three phases, each containing six groups. Groups 1, 2, and 3 received ENU at 6.25 mg/kg bw plus: (i) sham exposure to RF radiation (group 1); or (ii) exposure to RF radiation (group 2); or (iii) no treatment (cage control; group 3); while groups 4, 5 and 6 received ENU at 10.0 mg/kg bw plus: (i) sham exposure to RF radiation (group 4); or (ii) exposure to RF radiation (group 5); or (iii) no treatment (cage control; group 6). Necropsies were performed monthly on selected rats from each group, beginning at age 171 days. Exposure to RF radiation had no statistically significant effects on the survival or body weight of rats treated with ENU. Histopathological evaluation of tissues from the nervous system provided no evidence that exposure to the RF signal affected the incidence, multiplicity or latency of any type of neurogenic tumour ([Zook & Simmens, 2006](#)).

3.3 Co-carcinogenesis

See [Table 3.3](#)

To evaluate the possible effects of RF-radiation exposure on colon carcinogenesis, three groups

of 26–32 male and 26–32 female BALB/c mice (age, 4–5 weeks) were given dimethylhydrazine (DMH) as a subcutaneous injection at a dose of 15 mg/kg bw every week for 14 weeks, and subsequently at a dose of 20 mg/kg bw for 8 weeks. Starting 3 weeks after the first injection of DMH, the mice were either sham-exposed, exposed to RF radiation at 2450 MHz (SAR, 10–12 mW/g) for 3 hours per day, 6 days per week, for 5 months, or given weekly intraperitoneal injections of TPA at 2 µg per mouse for 10 weeks. Mice in the control group were given a subcutaneous injection of saline solution only. The incidences of tumours of the colon were similar in all groups treated with DMH ([Wu *et al.*, 1994](#)).

The possible effects of exposure to RF radiation on tumorigenesis were investigated in the offspring of pregnant female B6C3F₁ mice treated with ENU. Exposure of pregnant mice to RF radiation as a UMTS signal at 1966 MHz was initiated on day 6 of gestation, and was continued throughout pregnancy and for 2 years post-parturition. Pregnant mice were also intraperitoneally injected with ENU at a dose of 40 mg/kg bw on day 14 of gestation. Groups of 54–60 offspring were exposed to UMTS RF radiation at an intensity of 0, 4.8, or 48 W/m² for 20 hours per day, 7 days per week. Group 1 served as a cage control; group 2 was exposed to ENU only; group 3 was sham-exposed only; group 4 was exposed to ENU plus UMTS RF radiation at 4.8 W/m²; and group 5 was exposed to UMTS RF radiation at 48 W/m². Comparable incidences of tumours were seen in the groups that were not exposed to ENU. In groups exposed to ENU, UMTS RF radiation increased the incidence of bronchiolo-alveolar carcinoma and hepatocellular adenoma ([Tillmann *et al.*, 2010](#)). [The Working Group noted that this experimental model had not been used previously in other studies of hazard identification, and its concordance with the human carcinogenic response is unknown.]

Three groups of 45–49 transgenic female K2 mice overexpressing the human ornithine

decarboxylase (*ODC*) gene and their wild-type littermates were exposed to a combination of ultraviolet (UV) radiation and pulsed RF radiation. The UV dose was 240 J/m² delivered three times per week for 52 weeks. The mice were sham-exposed or exposed to RF radiation for 1.5 hours per day, 5 days per week, for 52 weeks. One group of mice was exposed to D-AMPS (digital advanced mobile phone system)-modulated RF radiation at 849 MHz; a second group was exposed to GSM RF radiation at 902.4 MHz; and a third group was sham-exposed. Nominal average SAR for both exposed groups was 0.5 mW/g. A cage-control group of 20 mice was included. There were no differences in the cumulative survival or body weight in groups exposed to UV, regardless of exposure to RF radiation. UV exposure induced macroscopic tumours of the skin in 12% of the non-transgenic mice and in 37% of the transgenic mice. Exposure to RF radiation had no effect on the induction of squamous cell carcinoma of the skin in either transgenic or wild-type mice ([Heikkinen et al., 2003](#)).

A study evaluated the possible effects of exposure to RF radiation on tumorigenesis induced by the mutagen 3-chloro-4-(dichloromethyl)-5-hydroxy-2(5*H*)-furanone (MX), a by-product of water disinfection. Groups of 72 female Wistar rats (age, 7 weeks) were given drinking-water containing MX at a daily average dose of 0 (cage-control) or 1.7 mg/kg bw for 104 weeks, and were then sham-exposed or exposed to pulsed RF radiation at 900 MHz (wbSARs of 0 [sham control], 0.3 or 0.9 mW/g) in restrainers for 2 hours per day, 5 days per week, for 104 weeks. Exposure to RF radiation had no statistically significant effects on mortality or body weight of rats treated with MX. Compared with the MX-treated sham-exposed control group [but not the cage control group], a statistically significant increase in the incidence of combined vascular tumours (haemangiomas, haemangiosarcomas and lymphangiomas combined) was

observed in the mesenteric lymph nodes of the group treated with MX and RF radiation at a high intensity (wbSAR, 0.9 mW/g). Exposure to RF radiation had no significant effect on the incidence of tumours in any other tissue ([Heikkinen et al., 2006](#)). [The Working Group noted that this experimental model had not been used previously in other hazard-identification studies, and its concordance with human carcinogenic response is unknown.]

Groups of 40 male BALB/c mice received 10 µL of a 5% solution of benzo[*a*]pyrene by skin painting on alternate days for 5 months, and were exposed to RF radiation as microwaves at 2450 MHz for 2 hours per day, 6 days per week, in an anechoic chamber, according to two different protocols. In the pre-exposure protocol, the mice were exposed to microwave radiation at SARs of 0 mW/g (sham) or 2–3 mW/g for 1 or 3 months before application of benzo[*a*]pyrene. In the simultaneous-exposure protocol, groups of mice were exposed to RF radiation at SARs of 0 mW/g, 2–3 mW/g, or 6–8 mW/g concurrently with administration of benzo[*a*]pyrene. Pre-exposure or simultaneous exposure to microwave radiation at either SAR value accelerated the development of benzo[*a*]pyrene-induced skin cancer. A comparable acceleration of skin tumorigenesis was reported in benzo[*a*]pyrene-treated mice undergoing confinement stress for 1 or 3 months ([Szmigielski et al., 1982](#)). [The Working Group noted that the study design and experimental data from this paper were poorly presented and difficult to interpret.]

In a second study performed by the same group, six groups of 100 adult male BALB/c mice were painted with 10 µL of 1% benzo[*a*]pyrene on the interscapular region of the skin on alternate days for 6 months. Two different schedules of exposure to microwave radiation at 2450 MHz were used. In the first experiment, three groups were exposed to microwave radiation (mean wbSAR, 4 mW/g) for 2 hours per day, 6 days per week, for 1, 2 or 3 months before the start of

Table 3.3 Co-carcinogenicity studies in experimental animals exposed to radiofrequency radiation

Species, strain (sex) Carcinogen Duration Reference	Dosing regimen Animals/group at start	Incidence of tumours	Significance	Comments
Mouse, K2 (<i>ODC</i> -transgenic and wild-type) (F) UV radiation: 240 J/m ² , 3 × /wk, 52 wk Heikkinen et al. (2003)	DAMPS-type (849 MHz) or GSM-type (902.4 MHz) RF, SAR: 0.5 mW/g 1.5 h/d, 5 d/wk, 52 wk Sham (<i>ODC</i> -transgenic + wild-type): 19 + 26; D-AMPS: 20 + 26; GSM: 22 + 27; and cage control: 12 + 8	Squamous-cell carcinoma of the skin: <i>ODC</i> -transgenic (sham): 6/19 <i>ODC</i> -transgenic (GSM): 5/21 <i>ODC</i> -transgenic (DAMPS): 8/20 Wild-type (sham): 2/26 Wild-type (GSM): 4/27 Wild-type (DAMPS): 4/26	NS	Restrained exposure Histopathological evaluation of all skin lesions
Rat, Wistar (F) 3-Chloro-4-(dichloromethyl)-5-hydroxy-2(5H)-furanone [MX], 1.7 mg/kg bw, drinking-water, 104 wk 104 wk Heikkinen et al. (2006)	GSM (900 MHz) PW (whole body) with wbSARs of 0.3 mW/g (low RF) or 0.9 mW/g (high RF), sham, cage control 2 h/d, 5 d/wk, 104 wk 72/group	Combined vascular tumours (haemangioma, haemangiosarcoma and lymphangioma) in the mesenteric lymph nodes (cage control, sham, low RF, high RF): 10/72 (14%), 3/72 (4%), 1/72 (1%), 11/72 (15%)	$P < 0.05$ (Fisher test), high RF vs sham	Complete histopathology No significant difference between high RF-radiation-exposed group and cage-control group
Mouse, BALB/c (M, F) DMH, 15 mg/kg bw per wk for 14 wk followed by 20 mg/kg bw per wk for 8 wk, i.p. 25 wk Wu et al. (1994)	2 450 MHz MW, 3 h/d, 6 d/wk, 5 mo, 10 mW/cm ² (SAR, 10–12 mW/g); sham exposure; or TPA promotion (i.p., 2 µg/wk, 10 wk) 3 wk after 1 st DMH injection A control group was i.p. injected with saline only 26–32/group	Colon tumours: DMH + sham: 13/28 (46%) DMH + MW: 13/26 (50%) DMH + TPA: 17/32 (53%) Control (saline only): 0/29 Protuberant or invasive colon tumours: DMH + sham: 13.9% DMH + MW: 16.3% DMH + TPA: 44.1%	- NS NS - NS $P < 0.05$	Single housing in small plexiglass cages during MW exposure Tumour bearing mice with total tumour areas > 5 mm ² : 71% in DMH + TPA-treated group ($P < 0.05$) vs 31% in DMH- and 31% in DMH + MW-treated groups.
Mouse, B6C3F ₁ (F) ENU, 40 mg/kg bw i.p., on GD 14 106 wk Tillmann et al. (2010)	1966 MHz, UMTS signal 20 h/d, 7 d/wk, 106 wk (starting on GD 6) 0 (sham), 4.8, 48 W/m ² SAR: variable Group 1: cage control Group 2: ENU Group 3: sham exposure Group 4: ENU + UMTS (4.8 W/m ²) Group 5: UMTS (48 W/m ²) 54–60/group	Bronchiolo-alveolar adenoma: group 4 (36/58, 62%) vs group 2 (27/60, 45%) Bronchiolo-alveolar carcinoma: group 4 (45/58, 78%) vs group 2 (33/60, 55%) Hepatocellular adenoma: group 4 (49/58, 85%) vs group 2 (30/60, 50%) Hepatocellular carcinoma: group 4 (30/58, 52%) vs group 2 (31/60, 52%) Comparable incidences of tumours in group 1, 3 and 5	NS $P < 0.05$ $P < 0.001$ NS	Tissues that were histopathologically evaluated included brain, lungs, liver, spleen, kidneys, mesenteric lymph nodes, and any gross lesions detected.

Table 3.3 (continued)

Species, strain (sex) Carcinogen Duration Reference	Dosing regimen Animals/group at start	Incidence of tumours	Significance	Comments
Mouse, BALB/c (M) <i>Exp. 1:</i> 1 or 3 mo irradiation before B[a]P skin painting on alternate days for 5 mo <i>Exp. 2:</i> 5 mo-irradiation simultaneously with B[a]P skin painting on alternate days for 5 mo Up to 12 mo Szmigielski et al. (1982)	2 450 MHz MW (far-field condition in an anechoic chamber) 2 h/d, 6 d/wk Confinement-stress controls were provided: mice were located individually in a chronic stress- syndrome compartment for 1–8 mo. <i>Exp. 1:</i> sham, 5 mW/cm ² (1 mo before B[a]P), 5 mW/cm ² (3 mo before B[a]P), confinement stress (1 mo before B[a] P), or confinement stress (3 mo before B[a]P) <i>Exp. 2:</i> sham, 5 mW/cm ² , 15 mW/cm ² or confinement stress SAR: 2–3 mW/g (5 mW/cm ²) or 6–8 mW/g (15 mW/cm ²) 40/group	<i>Exp. 1:</i> No. of mice with skin cancers: 0, 2, 22*, 3, 16* after 6 mo 4, 18*, 29*, 16*, 25* after 8 mo 19, 27**, 36**, 24, 31** after 10 mo <i>Exp. 2:</i> Number of mice with skin cancers: 0, 12*, 28*, 13* after 6 mo 5, 23*, 33*, 26* after 8 mo 21, 32*, 38*, 31* after 10 mo	* <i>P</i> < 0.01 ** <i>P</i> < 0.05 * <i>P</i> < 0.01	Distance from the antenna (vertical 30 × 30 cm horn antenna) to cages: 220 cm. Four cages (30 × 50 cm area cage) containing 10 mice each. Data are poorly presented and difficult to interpret.
Mouse, BALB/c (M) <i>Exp. 1:</i> 6 mo irradiation simultaneously with B[a] P skin painting <i>Exp. 2:</i> 1, 2 or 3 mo irradiation before B[a]P skin painting on alternate days for 6 mo Up to 12 mo Szudziński et al. (1982)	2 450-MHz MW (far field) 2 h/d, 6 d/wk <i>Exp. 1:</i> 0, 5 or 15 mW/cm ² , SAR: 0, 2 or 6 mW/g <i>Exp. 2:</i> three groups at 10 mW/cm ² wbSAR: 4 mW/g 100/group	Skin carcinoma <i>Exp. 1:</i> CDT ₅₀ of 296, 235, 131 days at 0, 5, 15 mW/cm ² <i>Exp. 2:</i> CDT ₅₀ of 253, 210, or 171 days after 1, 2 or 3 mo of irradiation [Control CDT ₅₀ : 296 days, see <i>Exp. 1</i>]	<i>P</i> < 0.05 at 15 mW/cm ² No <i>P</i> -values reported	No concurrent sham control in <i>Exp. 2</i>

B[a]P, benzo[a]pyrene; CNS, central nervous system; CDMA, code-division multiple access; CDT₅₀, cancer development time 50 (i.e. time in which 50% of the mice developed skin carcinoma); d, day; D-AMPS, digital advanced mobile phone service; DCS, Digital Personal Communication System; DEN, diethylnitrosamine; DMBA, 7,12-dimethylbenz[a]anthracene; DMH, dimethylhydrazine; EMF, electromagnetic field; ENU, *N*-ethyl-*N*-nitrosourea; FDMA, frequency-division multiple access; GD, gestational day; GSM, Global System for Mobile communication; i.p., intraperitoneal; i.v., intravenously; MMW, millimetre wavelength; mo, month; MW, microwave; NADC, North American Digital Cellular; NS, not significant; ODC, ornithine decarboxylase; PH, partial hepatectomy; p.o., oral administration; PRF, pulsed radiofrequency field; RF, radiofrequency radiation; SAR (wb, av), (time-averaged whole-body) specific absorption rate; s.c., subcutaneously; TDMA, time-division multiple access; TPA, 12-*O*-tetradecanoylphorbol-13-acetate UMTS, Universal Mobile Telecommunication System; UWB, ultra-wide band; WCDMA, wide-band code-division multiple access; wk, week

benzo[*a*]pyrene application. In the second experiment, three groups were exposed to RF radiation (wbSAR, 0 mW/g [sham-exposed control], 2 mW/g, or 6 mW/g), 2 hours per day, 6 days per week, for 6 months, concurrently with exposure to benzo[*a*]pyrene. Irradiation by either schedule resulted in an acceleration in the development of benzo[*a*]pyrene-induced skin carcinoma and decreased the lifespan of the animals ([Szudziński et al., 1982](#)). [The Working Group noted that the study design and experimental data were poorly presented and difficult to interpret. Survival and tumour data from groups receiving pre-exposure to microwave radiation may be invalid due to the lack of concurrent sham-exposed controls.]

References

- Adey WR, Byus CV, Cain CD *et al.* (1999). Spontaneous and nitrosourea-induced primary tumors of the central nervous system in Fischer 344 rats chronically exposed to 836 MHz modulated microwaves. *Radiat Res*, 152: 293–302. doi:10.2307/3580329 PMID:10453090
- Adey WR, Byus CV, Cain CD *et al.* (2000). Spontaneous and nitrosourea-induced primary tumors of the central nervous system in Fischer 344 rats exposed to frequency-modulated microwave fields. *Cancer Res*, 60: 1857–1863. PMID:10766172
- Anane R, Dulou PE, Taxile M *et al.* (2003). Effects of GSM-900 microwaves on DMBA-induced mammary gland tumors in female Sprague-Dawley rats. *Radiat Res*, 160: 492–497. doi:10.1667/RR3052 PMID:12968925
- Anderson LE, Sheen DM, Wilson BW *et al.* (2004). Two-year chronic bioassay study of rats exposed to a 1.6 GHz radiofrequency signal. *Radiat Res*, 162: 201–210. doi:10.1667/RR3208 PMID:15387148
- Anghileri LJ, Mayayo E, Domingo JL, Thouvenot P (2005). Radiofrequency-induced carcinogenesis: cellular calcium homeostasis changes as a triggering factor. *Int J Radiat Biol*, 81: 205–209. doi:10.1080/09553000500076957 PMID:16019929
- Bartsch H, Bartsch C, Seebald E *et al.* (2002). Chronic exposure to a GSM-like signal (mobile phone) does not stimulate the development of DMBA-induced mammary tumors in rats: results of three consecutive studies. *Radiat Res*, 157: 183–190. doi:10.1667/0033-7587(2002)157[0183:CETAGL]2.0.CO;2 PMID:11835682
- Bartsch H, Küpper H, Scheurlen U *et al.* (2010). Effect of chronic exposure to a GSM-like signal (mobile phone) on survival of female Sprague-Dawley rats: modulatory effects by month of birth and possibly stage of the solar cycle. *Neuro Endocrinol Lett*, 31: 457–473. PMID:20802457
- Breuer M, Slebos R, Verbeek S *et al.* (1989). Very high frequency of lymphoma induction by a chemical carcinogen in pim-1 transgenic mice. *Nature*, 340: 61–63. doi:10.1038/340061a0 PMID:2786994
- Chagnaud JL, Moreau JM, Veyret B (1999). No effect of short-term exposure to GSM-modulated low-power microwaves on benzo(a)pyrene-induced tumours in rat. *Int J Radiat Biol*, 75: 1251–1256. doi:10.1080/095530099139403 PMID:10549601
- Chou CK, Guy AW, Kunz LL *et al.* (1992). Long-term, low-level microwave irradiation of rats. *Bioelectromagnetics*, 13: 469–496. doi:10.1002/bem.2250130605 PMID:1482413
- Frei MR, Berger RE, Dusch SJ *et al.* (1998a). Chronic exposure of cancer-prone mice to low-level 2450 MHz radiofrequency radiation. *Bioelectromagnetics*, 19: 20–31. doi:10.1002/(SICI)1521-186X(1998)19:1<20::AID-BEM2>3.0.CO;2-6 PMID:9453703
- Frei MR, Jauchem JR, Dusch SJ *et al.* (1998b). Chronic, low-level (1.0 W/kg) exposure of mice prone to mammary cancer to 2450 MHz microwaves. *Radiat Res*, 150: 568–576. doi:10.2307/3579874 PMID:9806599
- Heikkinen P, Ernst H, Huuskonen H *et al.* (2006). No effects of radiofrequency radiation on 3-chloro-4-(dichloromethyl)-5-hydroxy-2(5H)-furanone-induced tumorigenesis in female Wistar rats. *Radiat Res*, 166: 397–408. doi:10.1667/RR3588.1 PMID:16881741
- Heikkinen P, Kosma VM, Alhonen L *et al.* (2003). Effects of mobile phone radiation on UV-induced skin tumourigenesis in ornithine decarboxylase transgenic and non-transgenic mice. *Int J Radiat Biol*, 79: 221–233. doi:10.1080/0955300031000096298 PMID:12775446
- Heikkinen P, Kosma VM, Hongisto T *et al.* (2001). Effects of mobile phone radiation on X-ray-induced tumorigenesis in mice. *Radiat Res*, 156: 775–785. doi:10.1667/0033-7587(2001)156[0775:EOMPRO]2.0.CO;2 PMID:11741502
- Hruby R, Neubauer G, Kuster N, Frauscher M (2008). Study on potential effects of “902-MHz GSM-type Wireless Communication Signals” on DMBA-induced mammary tumours in Sprague-Dawley rats. *Mutat Res*, 649: 34–44. PMID:17981079
- Huang TQ, Lee JS, Kim TH *et al.* (2005). Effect of radiofrequency radiation exposure on mouse skin tumorigenesis initiated by 7,12-dimethylbenz[α]anthracene. *Int J Radiat Biol*, 81: 861–867. doi:10.1080/09553000600568093 PMID:16524842
- Imaida K, Kuzutani K, Wang J *et al.* (2001). Lack of promotion of 7,12-dimethylbenz[*a*]anthracene-initiated mouse skin carcinogenesis by 1.5 GHz electromagnetic

- near fields. *Carcinogenesis*, 22: 1837–1841. doi:10.1093/carcin/22.11.1837 PMID:11698347
- Jauchem JR, Ryan KL, Frei MR *et al.* (2001). Repeated exposure of C3H/HeJ mice to ultra-wideband electromagnetic pulses: lack of effects on mammary tumors. *Radiat Res*, 155: 369–377. doi:10.1667/0033-7587(2001)155[0369:REOCHM]2.0.CO;2 PMID:11175673
- La Regina M, Moros EG, Pickard WF *et al.* (2003). The effect of chronic exposure to 835.62 MHz FDMA or 847.74 MHz CDMA radiofrequency radiation on the incidence of spontaneous tumors in rats. *Radiat Res*, 160: 143–151. doi:10.1667/RR3028 PMID:12859224
- Lee HJ, Jin YB, Lee JS *et al.* (2011). Lymphoma development of simultaneously combined exposure to two radiofrequency signals in AKR/J mice. *Bioelectromagnetics*, n/a doi:10.1002/bem.20655 PMID:21437920
- Mason PA, Walters TJ, DiGiovanni J *et al.* (2001). Lack of effect of 94 GHz radio frequency radiation exposure in an animal model of skin carcinogenesis. *Carcinogenesis*, 22: 1701–1708. doi:10.1093/carcin/22.10.1701 PMID:11577012
- Oberto G, Rolfo K, Yu P *et al.* (2007). Carcinogenicity study of 217 Hz pulsed 900 MHz electromagnetic fields in Pim1 transgenic mice. *Radiat Res*, 168: 316–326. doi:10.1667/rr0425.1 PMID:17705642
- Paulraj R & Behari J (2011). Effects of low level microwave radiation on carcinogenesis in Swiss Albino mice. *Mol Cell Biochem*, 348: 191–197. doi:10.1007/s11010-010-0654-8 PMID:21086023
- Repacholi MH, Basten A, Gebiski V *et al.* (1997). Lymphomas in E mu-Pim1 transgenic mice exposed to pulsed 900 MHz electromagnetic fields. *Radiat Res*, 147: 631–640. doi:10.2307/3579630 PMID:9146709
- Saran A, Pazzaglia S, Mancuso M *et al.* (2007). Effects of exposure of newborn patched1 heterozygous mice to GSM, 900 MHz. *Radiat Res*, 168: 733–740. doi:10.1667/RR1065R1.1 PMID:18088186
- Shirai T, Ichihara T, Wake K *et al.* (2007). Lack of promoting effects of chronic exposure to 1.95-GHz W-CDMA signals for IMT-2000 cellular system on development of N-ethylnitrosourea-induced central nervous system tumors in F344 rats. *Bioelectromagnetics*, 28: 562–572. doi:10.1002/bem.20324 PMID:17516507
- Shirai T, Kawabe M, Ichihara T *et al.* (2005). Chronic exposure to a 1.439 GHz electromagnetic field used for cellular phones does not promote N-ethylnitrosourea induced central nervous system tumors in F344 rats. *Bioelectromagnetics*, 26: 59–68. doi:10.1002/bem.20079 PMID:15605402
- Smith P, Kuster N, Ebert S, Chevalier HJ (2007). GSM and DCS wireless communication signals: combined chronic toxicity/carcinogenicity study in the Wistar rat. *Radiat Res*, 168: 480–492. doi:10.1667/RR0680.1 PMID:17903030
- Sommer AM, Bitz AK, Streckert J *et al.* (2007). Lymphoma development in mice chronically exposed to UMTS-modulated radiofrequency electromagnetic fields. *Radiat Res*, 168: 72–80. doi:10.1667/RR0857.1 PMID:17723000
- Sommer AM, Streckert J, Bitz AK *et al.* (2004). No effects of GSM-modulated 900 MHz electromagnetic fields on survival rate and spontaneous development of lymphoma in female AKR/J mice. *BMC Cancer*, 4: 77 doi:10.1186/1471-2407-4-77 PMID:15538947
- Szmiagielski S, Szudzinski A, Pietraszek A *et al.* (1982). Accelerated development of spontaneous and benzo-pyrene-induced skin cancer in mice exposed to 2450-MHz microwave radiation. *Bioelectromagnetics*, 3: 179–191. doi:10.1002/bem.2250030202 PMID:7126270
- Szudziński A, Pietraszek A, Janiak M *et al.* (1982). Acceleration of the development of benzopyrene-induced skin cancer in mice by microwave radiation. *Arch Dermatol Res*, 274: 303–312. doi:10.1007/BF00403734 PMID:6299207
- Tillmann T, Ernst H, Ebert S *et al.* (2007). Carcinogenicity study of GSM and DCS wireless communication signals in B6C3F₁ mice. *Bioelectromagnetics*, 28: 173–187. doi:10.1002/bem.20283 PMID:17019729
- Tillmann T, Ernst H, Streckert J *et al.* (2010). Indication of cocarcinogenic potential of chronic UMTS-modulated radiofrequency exposure in an ethylnitrosourea mouse model. *Int J Radiat Biol*, 86: 529–541. doi:10.3109/09553001003734501 PMID:20545575
- Toler JC, Shelton WW, Frei MR *et al.* (1997). Long-term, low-level exposure of mice prone to mammary tumors to 435 MHz radiofrequency radiation. *Radiat Res*, 148: 227–234. doi:10.2307/3579606 PMID:9291353
- Utteridge TD, Gebiski V, Finnie JW *et al.* (2002). Long-term exposure of E-mu-Pim1 transgenic mice to 898.4 MHz microwaves does not increase lymphoma incidence. *Radiat Res*, 158: 357–364. doi:10.1667/0033-7587(2002)158[0357:LTEOEP]2.0.CO;2 PMID:12175314
- van Kreijl CF, van der Houven van Oordt CW, Kroese ED *et al.* (1998). Evaluation of the Emu-pim-1 transgenic mouse model for short-term carcinogenicity testing. *Toxicol Pathol*, 26: 750–756. doi:10.1177/019262339802600606 PMID:9864091
- Wu RY, Chiang H, Shao BJ *et al.* (1994). Effects of 2.45-GHz microwave radiation and phorbol ester 12-O-tetradecanoylphorbol-13-acetate on dimethylhydrazine-induced colon cancer in mice. *Bioelectromagnetics*, 15: 531–538. doi:10.1002/bem.2250150606 PMID:7880166
- Yu D, Shen Y, Kuster N *et al.* (2006). Effects of 900 MHz GSM wireless communication signals on DMBA-induced mammary tumors in rats. *Radiat Res*, 165: 174–180. doi:10.1667/RR3497.1 PMID:16435916
- Zook BC & Simmens SJ (2001). The effects of 860 MHz radiofrequency radiation on the induction or promotion of brain tumors and other neoplasms in rats. *Radiat Res*, 155:

572–583. doi:10.1667/0033-7587(2001)155[0572:TEOM
RR]2.0.CO;2 PMID:11260659

Zook BC & Simmens SJ (2002). Effects of a cell phone radi-
ofrequency (860 MHz) on the latency of brain tumors
in rats. *Int Congr Ser*, 1236: 137–139. doi:10.1016/
S0531-5131(01)00779-8

Zook BC & Simmens SJ (2006). The effects of pulsed 860
MHz radiofrequency radiation on the promotion of
neurogenic tumors in rats. *Radiat Res*, 165: 608–615.
doi:10.1667/RR3551.1 PMID:16669743

4. OTHER RELEVANT DATA

Data on specific absorption rate (SAR) and distribution of radiofrequency (RF) radiation inside tissues and organs and at the subcellular level are presented elsewhere in this Volume (Section 1.3, Dosimetry).

4.1 Genetic and related effects

4.1.1 Humans

During the past decades, extensive research efforts have focused on determining the extent of DNA damage in eukaryotic and prokaryotic cells exposed to RF radiation. Several published reviews concluded that: (i) the existing data are not sufficiently strong to suggest that RF radiation is directly genotoxic; (ii) exposure to RF radiation probably does not enhance the damage induced by known genotoxic agents; and (iii) some of the reported “adverse effects” may be attributed to hyperthermia induced by RF radiation ([Brusick et al., 1998](#); [Verschaeve & Maes, 1998](#); [Moulder et al., 1999, 2005](#); [Heynick et al., 2003](#); [Meltz, 2003](#); [Vijayalaxmi & Obe, 2004](#); [Verschaeve, 2005](#); [Krewski et al., 2007](#); [Lai, 2007](#); [Vijayalaxmi & Prihoda, 2008](#); [Phillips et al., 2009](#); [Rüdiger, 2009a](#); [Verschaeve, 2009](#); [Verschaeve et al., 2010](#)). International organizations and expert scientific advisory groups in several countries, including Canada, France, the Netherlands, Sweden, the United Kingdom and the USA, have reached similar conclusions ([ICNIRP, 2009](#)).

This Section of the *Monograph* deals with studies on primary DNA damage in humans exposed occupationally or as mobile-phone users;

in these studies DNA damage was measured in peripheral blood lymphocytes and buccal cells by means of the alkaline or neutral single-cell gel electrophoresis assay (comet assay), which reveals alkali-labile lesions and single- and double-strand breaks in DNA, or by use of cytogenetic tests for chromosomal aberrations, micronucleus formation and sister-chromatid exchange (SCE). The studies reviewed below are summarized in [Table 4.1](#) and [Table 4.2](#) (with details of the exposure conditions).

(a) Peripheral blood lymphocytes

(i) Occupational exposure

[Garaj-Vrhovac et al. \(1990a\)](#) were the first to report an increased frequency of chromosomal aberrations in the form of chromatid and chromosome breaks, acentric fragments, dicentrics, rings and polycentric chromosomes, as well as micronuclei in 10 individuals employed in a radar service-station facility. The frequency of cells with chromosomal aberrations and micronuclei ranged from 1.6% to 31.5% and from 1.6% to 27.9%, respectively, in exposed subjects, while the corresponding values in controls were 1.8% and 1.5% [no range given].

In a study in Australia, [Garson et al. \(1991\)](#) collected lymphocytes from 38 radio linesmen,

Table 4.1 Genetic and related effects of radiofrequency radiation in peripheral blood lymphocytes of occupationally exposed individuals

End-point	No. of subjects	Occupation	Frequency	SAR or power density	Duration	Results	Reference
Aneuploidy	18	Air-traffic controllers; engineers	100 kHz to 300 GHz	-	10–27 yr	+	Othman <i>et al.</i> (2001)
CA	10	Radar maintenance workers	0.2 MHz to 26 GHz	0.010–50 mW/cm ²	8–25 yr	+	Garaj-Vrhovac <i>et al.</i> (1990a)
CA	38	Radio linesmen	400 kHz to 20 GHz	614 V/m	5 yr	-	Garson <i>et al.</i> (1991)
CA	6	Air-traffic radar-repairmen	1250–1350 MHz	0.01–20 mW/cm ²	16 yr	+ [after a 30-wk follow-up, total aberrations had decreased]	Garaj-Vrhovac <i>et al.</i> (1993)
CA	6	Transmission-antenna maintenance workers	450–900 MHz	NR	1 yr	-	Maes <i>et al.</i> (1995)
CA	20	Workers in telecommunication and radio-relay stations	8 GHz	1 mW/cm ²	6 yr (12 h/d)	+	Lalić <i>et al.</i> (2001)
CA	50	Air-traffic controllers, engineers	100 kHz to 300 GHz	NR	8–27 yr	+	Aly <i>et al.</i> (2002)
CA	49	Radio engineers	450–900 MHz	NR	2.3 yr (> 1 h/d)	-	Maes <i>et al.</i> (2006)
CA	10	Radar maintenance workers	1250–1350 MHz	0.010–20 mW/cm ²	7–29 yr	+	Garaj-Vrhovac & Orescanin (2009)
MN	10	Radar maintenance workers	0.2 MHz to 26 GHz	0.010–50 mW/cm ²	8–25 yr	+	Garaj-Vrhovac <i>et al.</i> (1990a)
MN	NR	Multiple occupations	1250–1350 MHz	0.01–20 mW/cm ²	15 yr	+	Fucić <i>et al.</i> (1992)
MN	12	Radar maintenance workers	1250–1350 MHz	0.01–20 mW/cm ²	13 yr	+	Garaj-Vrhovac (1999)
SB	40	Flight crew	NR	NR	5–18 yr	-	Cavallo <i>et al.</i> (2002)
SB	49	Radio engineers	450–900 MHz	NR	2.3 yr (> 1 h/d)	-	Maes <i>et al.</i> (2006)
SB	10	Radar maintenance workers	1250–1350 MHz	0.010–20 mW/cm ²	7–29 yr	+	Garaj-Vrhovac & Orescanin (2009)
SCE	50	Air-traffic controllers	100 kHz to 300 GHz	NR	8–27 yr	-	Aly <i>et al.</i> (2002)
SCE	49	Radio engineers	450–900 MHz	NR	2.3 yr (> 1 h/d)	-	Maes <i>et al.</i> (2006)

+ increase; -, no effect; CA, chromosomal aberration; d, day; h, hour; MN, micronucleus formation; NR, not reported; SAR, specific absorption rate; SB, DNA single- and double-strand breaks; SCE, sister-chromatid exchange; wk, week; yr, year

Table 4.2 Genetic and related effects of radiofrequency radiation in peripheral blood lymphocytes and buccal cells of mobile-phone users

End-point	No. of subjects	Frequency	SAR	Duration	Results	Reference
<i>Peripheral blood lymphocytes</i>						
CA	24	890–960 MHz	NR	2 yr	+	Gadhia et al. (2003)
CA	25	NR	0.1–1.9 W/kg	3–5 yr	+	Gandhi & Singh (2005)
MN	24	800–2000 MHz	0.6–1.6 W/kg	1–5 yr	+	Gandhi & Anita (2005)
SB	24	800–2000 MHz	0.6–1.6 W/kg	1–5 yr	+	Gandhi & Anita (2005)
SCE	24	890–960 MHz	NR	2 yr	+	Gadhia et al. (2003)
<i>Buccal cells</i>						
MN	25	NR	0.1–1.9 W/kg	3–5 yr	+	Gandhi & Singh (2005)
MN	85	NR	0.3–1.0 W/kg	2.3 yr (1 h/d)	+	Yadav & Sharma (2008)
MN	112	NR	NR	5–10 yr (3 h/wk)	–	Hintzsche & Stopper (2010)

+, increase; –, no effect; CA, chromosomal aberration; d, day; h, hour; MN, micronucleus formation; NR, not reported; SAR, specific absorption rate; SB, DNA single- and double-strand breaks; SCE, sister-chromatid exchange; wk, week; yr, year

who erected and maintained broadcasting, telecommunication and satellite RF-transmission towers, and found no increase in the frequency of chromosomal aberrations compared with the frequency in 38 controls working as clerical staff. In this study, exposure to RF radiation was at or below occupational limits for Australia.

[Fucić et al. \(1992\)](#) measured the surface area of micronuclei in lymphocytes of workers in multiple occupations exposed to pulsed microwaves, X-rays (< 25 mSv during the previous 2 years) and vinyl-chloride monomer (VCM; average concentration, 50 ppm). The sample size in each category was not mentioned in the paper. There were increased numbers of smaller micronuclei in individuals exposed to X-rays and VCM, indicating a clastogenic effect. Increased numbers of smaller as well as larger micronuclei were found in individuals exposed to microwaves, suggesting a dual role of this type of radiation, as clastogen and aneugen.

In a regular 30-week follow-up investigation of six individuals who were acutely exposed to pulsed-wave RF radiation of high power density at an air-traffic radar-repair station,

[Garaj-Vrhovac et al. \(1993\)](#) observed a decline in the total number of chromosomal aberrations.

A preliminary study conducted by [Maes et al. \(1995\)](#) involved six workers in charge of maintaining transmission antennae linked to a mobile-phone network, and six matched controls. No increase in the frequency of chromosomal aberrations was observed in the maintenance workers. The authors mentioned the limited size of the study and the fact that exposure to RF radiation was intermittent. They then extended the study to 49 professionally employed radio engineers working in the field, and 11 administrative staff. Some of these had participated in the earlier study. No differences between exposed and controls were observed with the alkaline comet assay, the assay for chromosomal aberration, or the test for SCE ([Maes et al., 2006](#)).

[Garaj-Vrhovac \(1999\)](#) examined 12 subjects employed in repair services for radar equipment and antennae, and reported frequencies of 8–23 micronuclei per 500 cells in exposed workers compared with 2–7 per 500 cells in control subjects; this difference was statistically significant.

[Lalić et al. \(2001\)](#) investigated 20 workers in telecommunication and radio-relay stations who were exposed to non-ionizing electromagnetic fields, and 25 subjects employed as X-ray technicians, nurses and engineers in radiology, exposed to ionizing radiation. The analysis indicated an increased frequency of chromosomal aberration in both groups. The incidence of dicentric chromosomes was higher in the group exposed to non-ionizing radiation than in the group exposed to ionizing radiation.

[Othman et al. \(2001\)](#) studied professional air-traffic controllers and engineers exposed to RF radiation emitted by different pieces of equipment at the workplace. In a first study, blood lymphocytes were collected from 18 workers and 5 unexposed controls (all males), and cultured for 72 hours. Fluorescence *in situ* hybridization (FISH) with repetitive α -satellite probes for chromosomes 7, 12, 17, and the heterochromatic region of the Y-chromosome, was used to determine the number of aneuploid cells. The results showed increased frequencies of monosomic cells containing a single copy of chromosome 7 (6.6%) or 17 (6.1%), and of cells lacking the Y-chromosome (8.4%): the corresponding values for the controls were 3.2%, 3.7% and 4.5%, respectively.

In a further study by the same group, [Aly et al. \(2002\)](#) examined lymphocytes from 26 air-traffic controllers, 24 engineers and 10 controls. Conventional cytogenetic techniques revealed an increase in the frequency of structural aberrations (2.7–5.3%) and numerical aberrations (8.9–9.3%) in exposed individuals relative to controls (0.8% and 3.2%, respectively). In subjects exposed to RF radiation, 90% of the cells were hypodiploid, i.e. showed loss of chromosomes. The frequency of SCE was also increased, but this increase did not reach statistical significance. [The Working Group noted that conventional cytogenetic techniques may be less reliable than the FISH technique for counting numerical aberrations.]

[Cavallo et al. \(2002\)](#) studied 40 airline pilots and flight technicians exposed to cosmic rays, electromagnetic fields from radar equipment, pollutants from jet-propulsion fluid etc. and 40 non-exposed individuals working on the ground. In the comet assay, visual examination of the results revealed a small increase in the frequency of DNA strand breaks in exposed individuals compared with ground staff, but this increase was not statistically significant.

[Garaj-Vrhovac & Orescanin \(2009\)](#) used the comet assay to measure DNA strand breaks and the test for sensitivity to bleomycin described by [Michalska et al. \(1998\)](#) to investigate genomic instability in 10 individuals working in radar-equipment and antenna-system services, and in 10 control subjects. In the latter method, the cells were treated with bleomycin (a drug used in clinical treatment of cancer) during the last 5 hours before harvesting after a culture period of 72 hours, to assess the incidence of chromosomal aberrations in the form of chromatid breaks. The results of the comet assay revealed increased DNA damage (tail length, 17.1 μm , and tail moment, 14.4, in the exposed individuals compared with 14.2 μm and 11.7, respectively, in the controls). The test for sensitivity to bleomycin showed a higher number of chromatid breaks (1.7 per cell in the exposed, compared with 0.5 per cell in the controls). All these differences were statistically significant.

[The Working Group noted the following limitations in the above-mentioned studies. Exposure assessment was poor or was not mentioned in many reports. The sample size in terms of number of individuals or number of cells analysed was not sufficient to allow robust statistical analysis. Except in one study, “blind” evaluation of microscope slides, and inclusion of positive controls (subjects or cells) while culturing the lymphocytes *in vitro*, was either not performed or not reported. Several investigations were conducted with blood samples collected from workers in one radar-service

facility in Croatia; it was unclear whether the same individuals had been included in more than one of these studies.]

[Although the reports from Australia ([Garson et al., 1991](#)) and Belgium ([Maes et al., 1995](#)) indicated no effect on the frequency of chromosomal aberrations from exposure to RF radiation, the Working Group noted that situations and exposure conditions in those countries may not have been comparable to those in other countries. Chromosomal changes are highly variable during carcinogenesis and are generally grouped into two categories: (i) reciprocal and balanced structural rearrangements resulting in translocations; and (ii) unbalanced and nonreciprocal structural or numerical changes in which genetic material may be lost or added: the latter can range from a single base pair to the entire chromosome. In the studies reviewed above, reciprocal and balanced structural rearrangements were either not observed or not reported in individuals exposed to RF radiation.]

(ii) *Personal exposure from mobile phones*

[Gadhia et al. \(2003\)](#) collected samples of peripheral blood from 24 users of digital mobile phones and 24 matched controls. Both groups comprised 12 nonsmokers/nondrinkers and 12 smokers/alcoholics [smokers consumed 10–15 cigarettes per day; data on alcohol consumption were not given]. Cytogenetic analysis of lymphocytes cultured for 72 hours indicated a significantly increased incidence ($P < 0.05$) of chromatid gaps and dicentric chromosomes among mobile-phone users who smoked and drank alcohol, but not in nonsmokers/nondrinkers. A significantly increased frequency ($P < 0.05$) of SCE was seen in mobile-phone users of both categories.

[Gandhi & Singh \(2005\)](#) studied G-banded chromosomes in lymphocytes (cultured for 72 hours) from 25 users of mobile phones and 25 non-users. There was a statistically significant increase in the frequency of aberrant metaphases,

including triploid chromosomes, acrocentric associations and centromere separation in lymphocytes of mobile-phone users (31.3%) compared with non-users (10.7%). In a subsequent study, [Gandhi & Anita \(2005\)](#) investigated DNA strand breaks by use of the comet assay in lymphocytes from 24 mobile-phone users and 10 controls. Unstimulated lymphocytes were also examined to record the frequency of micronuclei in 20 of those users and 8 non-users. In mobile-phone users, the frequency of damaged cells was 40%, with an average comet-tail length of 27 μm (determined by visual examination with a micrometer), while these values were lower in non-users, at 10% and 8 μm , respectively; both differences were highly significant. The total number of micronuclei was 100 in 40 000 cells in users, and 8 in 16 000 cells in non-users, *i.e.* 2.5% in the former and 0.5% in the latter ($P < 0.05$). [The Working Group noted that the observations reported by [Gandhi & Singh \(2005\)](#) and [Gandhi & Anita \(2005\)](#) were questioned by others ([Vijayalaxmi et al., 2007](#)), pointing out several inconsistencies and weaknesses in laboratory methods, data collection, exposure assessment, etc. in both publications.]

(b) *Buccal cells: personal exposure from mobile phones*

The oral cavity is within the range of RF emissions from mobile phones used at the ear. Hence, examination of the cells in this region is relevant to evaluation of genotoxicity. The oral mucosa has a rich blood supply and is relatively permeable. It has an outer layer of stratified squamous epithelium that is approximately 40–50 cell-layers thick. These exfoliating cells can easily be obtained by non-invasive procedures (oral swabs) from adults, adolescents and children. The turnover of these cells is estimated at 1–3 weeks ([Harris & Robinson, 1992](#)).

The frequency of micronuclei in exfoliated buccal cells has been investigated in mobile-phone users. [Gandhi & Singh \(2005\)](#) collected

buccal cells from 25 mobile-phone users and 25 non-users. The average frequencies of micronuclei (in %) were 0.82 ± 0.09 in users and 0.06 ± 0.003 in non-users ($P < 0.05$). [The Working Group noted the same limitations for this study as those mentioned above.]

[Yadav & Sharma \(2008\)](#) collected buccal cells from 85 mobile-phone users and 24 controls. In a total of 1000 cells from each donor, the frequency of micronuclei was determined, along with other indications of degeneration, i.e. karyolysis, karyorrhexis, “broken egg” effect, and binucleate cells. The mean frequency in users (10.7 per 1000 cells) was significantly higher than that in non-users (4.0 per 1000 cells). The changes in incidence of other end-points were not statistically significant. There was also a positive, albeit non-significant, correlation of the total number of micronuclei with increased duration of mobile-phone use.

[Hintzsche & Stopper \(2010\)](#) determined the frequency of micronuclei in buccal cells from 112 mobile-phone users and 13 non-users. Four patients receiving radiotherapy were included as positive controls, along with four healthy controls. The average frequency of micronucleus formation in users was not different from that in non-users. Also, there was no difference when the users were subdivided according to the number of hours of use per week and duration of use of up to 10 years. In contrast, the frequency of micronucleated cells in patients receiving radiotherapy was 131 ± 29.1 per 1000 cells. The authors mentioned that the larger number of individuals studied, the use of DNA-specific staining, and the genotypic variation in the study populations may have contributed to the discrepancy between their results and those of [Yadav & Sharma \(2008\)](#).

[The Working Group noted that counting of 2000 differentiated cells and 200 basal cells is recommended for studies using buccal cells, ([Thomas & Fenech, 2011](#)); this was not accomplished in the studies discussed above. Known confounding factors such as tobacco smoking

and alcohol consumption were mentioned in some of the studies, but in view of the limited sample size the influence of such factors on the observed abnormalities is difficult to determine.]

[The Working Group further noted that studies of genotoxicity in humans exposed to RF radiation have been carried out by a limited number of research groups; that methodological weaknesses were found in many studies; and that confounding factors were generally not addressed. Overall, although there were studies with positive results for genotoxicity associated with occupational exposure to RF radiation or with the use of mobile phones, the Working Group concluded that the available evidence was not strong enough to draw firm conclusions.]

4.1.2 Experimental systems: in vivo

The studies on experimental animals exposed to RF radiation were not uniformly clear in describing the rationale for choosing a specific dose.

(a) *Drosophila melanogaster*

Adult male fruit flies (*Drosophila melanogaster*) were exposed to RF radiation at either 146.34 MHz produced by a transmitter of 20 W, or 29.00 MHz produced by a transmitter of 300 W, for 12 hours ([Mittler, 1976](#)). Loss of the X or Y chromosomes, nondisjunction, and the induction of sex-linked recessive lethal mutations were investigated. There was no significant difference between exposed and non-exposed flies for any of these end-points.

In a subsequent study ([Mittler, 1977](#)), *D. melanogaster* were exposed to RF radiation at 98.5 MHz (field strength, 0.3 V/m) for 32 weeks. No significant difference in the incidence of sex-linked recessive lethal mutations was observed in the exposed group compared with the controls.

[Hamnerius et al. \(1979\)](#) examined the effect of exposure to RF radiation on somatic mutation of genes involved in eye pigmentation in

D. melanogaster. When embryos were exposed to continuous-wave RF radiation at 2450 MHz (average SAR, 100 W/kg) for 6 hours, no evidence of mutagenicity was found. The same investigators used the same test system to examine mutation frequency in *D. melanogaster* under different conditions of exposure for 6 hours: continuous-wave radiation at 2.45 GHz, pulsed-wave radiation at 3.1 GHz, and continuous-wave magnetic or electric fields at 27.12 MHz. Under none of these conditions was a change in mutation frequency observed ([Hamnerius et al., 1985](#)).

[Marec et al. \(1985\)](#) investigated the effect of repeated exposures to RF radiation on sex-linked recessive lethal mutations in *D. melanogaster* exposed to continuous-wave RF radiation at 2375 MHz (SAR values: 15 W/cm² for 60 minutes per day; or 20 W/cm² for 10 minutes per day; or 25 W/cm² for 5 minutes per day) for five consecutive days. The mutation frequency in the groups exposed to RF radiation was not significantly different from that in the control group.

In a series of studies from Greece, adverse effects were reported on the reproduction of *D. melanogaster* after exposure to RF radiation at non-thermal mobile-phone frequencies (900 or 1800 MHz). In these experiments commercially available mobile phones were used as exposure devices. The exposures were conducted with the mobile-phone antenna outside the glass vials containing the flies, either in contact with or at a certain distance from the glass wall. The daily duration of exposure varied from 1 to 20 minutes, depending on the experiment. Exposure always started on the day of eclosion and lasted for a total of 5 or 6 days. The temperature within the vials during exposure was monitored with a mercury thermometer with an accuracy of 0.05 °C. The authors explained the decreased reproductive ability as the result of RF radiation-induced DNA fragmentation in the gonads ([Panagopoulos, 2011](#); [Panagopoulos & Margaritis, 2008, 2010a, b](#); [Panagopoulos et al., 2004, 2007, 2010](#)).

[In reviewing these studies with *Drosophila*, the Working Group noted several shortcomings related to the methods of exposure assessment and temperature control, which could have influenced the results.]

(b) *Mouse*

See [Table 4.3](#)

(i) 900 MHz

[Sykes et al. \(2001\)](#) studied somatic intrachromosomal recombination in the spleen of transgenic pKZ1 mice exposed to pulsed-wave RF radiation at 900 MHz (SAR, 4 W/kg) for 30 minutes per day, for 1, 5, or 25 days. There was a significant reduction in inversions below the spontaneous frequency in the group exposed for 25 days, whereas no effect was found in mice exposed for 1 or 5 days. The authors indicated that the number of mice in each treatment group in this study was small, and that repetition of this study with a larger number of mice was therefore required to confirm these observations.

[Aitken et al. \(2005\)](#) found a significant genotoxic effect on the epididymal spermatozoa of CD1 Swiss mice exposed to low-level RF radiation at 900 MHz (SAR, 0.09 W/kg) for 12 hours per day, for 7 days. No impact on male germ-cell development was observed. [The Working Group noted that insufficient information on dosimetry was provided in this study, which prevented a complete evaluation.]

Two cytogenetic studies were conducted with mice exposed to RF radiation from a mobile phone, with or without coexposure to X-rays or ultraviolet (UV) light. In the first study, female CBA/S mice were exposed for 78 weeks (1.5 hours per day, 5 days per week) either to continuous-wave RF radiation at 902.5 MHz (whole-body SAR, 1.5 W/kg) similar to that emitted by analogue NMT (Nordic Mobile Telephony) phones, or to a pulsed-wave signal at 902.4 MHz (SAR, 0.35 W/kg) similar to that emitted by digital GSM phones. All mice, except

the cage controls, were also exposed to X-rays (3×1.33 Gy; interval, 1 week) for the first 3 weeks of this experiment. In the second study, female transgenic mice (line K2) and their non-transgenic littermates were exposed to one of two digital mobile-phone signals at a frequency of 849 MHz GSM or 902 MHz DAMPS (Digital Advanced Mobile Phone System), with a SAR of 0.5 W/kg, for 1.5 hours per day, 5 days per week, for 52 weeks. All mice in the second study, except the cage controls, were also exposed to UV radiation mimicking the solar spectrum at 1.2 times the human minimal erythema dose (MED, 200 J/m²), three times per week. The results did not show any effects of RF fields on frequency of micronuclei in polychromatic erythrocytes or normochromatic erythrocytes, either alone or in combination with X-rays or UV radiation. The results were consistent in the two mouse strains (and in a transgenic variant of the second strain), after 52 or 78 weeks of exposure, at three SAR levels relevant to human exposure from mobile phones, and for three different mobile signals ([Juutilainen et al., 2007](#)).

(ii) 900 and 1800 MHz

In a study in B6C3F₁ mice exposed to RF radiation at 900 MHz or 1800 MHz (2 hours per day, for 1 week or 6 weeks) at different intensities (with SARs up to 33.2 W/kg in the 1-week experiment, and 24.9 W/kg in the 6-week experiment), the frequency of micronuclei was not increased in erythrocytes of peripheral blood or bone marrow, in keratinocytes or in spleen lymphocytes of the exposed animals compared with controls ([Görlitz et al., 2005](#)).

In a long-term study, micronucleus formation was measured in erythrocytes of B6C3F₁/CrIBR mice exposed to RF radiation at 902 MHz GSM or 1747 MHz (DCS, Digital Cellular System), at SARs of 0.4, 1.3 or 4.0 W/kg, for 2 hours per day, 5 days per week, for 2 years. No differences were found in the frequencies of micronuclei in exposed, sham-exposed or cage-control mice ([Ziemann et al., 2009](#)).

(iii) 1500 MHz

Male Big Blue mice, which are transgenic for the *lacI* marker gene, were locally exposed (in the head region) to near-field RF radiation at 1500 MHz with SARs of 0.67 or 2.0 W/kg, for 90 minutes per day, 5 days per week, for 4 weeks. There was no significant difference between exposed and control mice in the frequency of mutation in the *lacI* transgene in the brain ([Takahashi et al., 2002](#)).

(iv) 450 MHz

[Sarkar et al. \(1994\)](#) found significant alterations in the length of a DNA microsatellite sequence in the brain and testes of Swiss albino mice exposed to RF radiation at 2450 MHz (power level, 1 mW/cm²; SAR, 1.18 W/kg) for 2 hours per day, for 120, 150 or 200 days. The authors hypothesized that a DNA fragment (7.7 kb) – generated by the restriction enzyme *HinfI* – that was found after exposure could represent a hypermutable locus and that exposure to these microwaves may have led to amplification of tandem sequences, generating more copies of 5'-GACA-3' sequences in this particular region. The authors also indicated that the radiation dose applied in the study was close to the prescribed safe limit for population exposure, according to Guidelines of the International Radiation Protection Association at the time ([IRPA, 1988](#)).

C3H/HeJ mice were exposed continuous-wave RF radiation at 2450 MHz in circularly polarized wave-guides (average whole-body SAR, 1.0 W/kg) for 20 hours per day, 7 days per week, for 18 months. Peripheral-blood and bone-marrow smears were examined for the presence of micronuclei in polychromatic erythrocytes. The initial publication reported no difference in micronucleus formation between exposed and sham-exposed mice, but a subsequent correction indicated that there was a slight but significant increase in the incidence of micronucleated cells in peripheral-blood and bone-marrow smears

of mice receiving long-term exposure to this RF radiation ([Vijayalaxmi et al., 1997a, 1998](#)).

Pregnant *lacZ*-transgenic mice (MutaTMMouse) were exposed (16 hours per day) to intermittent (10 seconds on, 50 seconds off) RF radiation at 2450 MHz with an average whole-body SAR of 0.71 W/kg (4.3 W/kg during the exposure periods of 10 seconds), daily between day 0 and day 15 of gestation. Offspring were examined at age 10 weeks. Mutation frequencies at the *LacZ* gene in the spleen, liver, brain, and testis were similar to those observed in offspring of sham-exposed mice ([Ono et al., 2004](#)).

(v) 42 GHz (millimetre waves)

Adult male BALB/c mice were exposed (30 minutes per day) in the nasal region to RF radiation at 42 GHz (incident power density, 31.5 mW/cm²; peak SAR, 622 W/kg), on three consecutive days. The frequency of micronuclei in peripheral blood and in bone marrow was not increased in exposed mice compared with sham-exposed controls. One group of mice received a single injection of cyclophosphamide (15 mg/kg bw) immediately after the exposure to RF radiation on day 2. The micronucleus frequency in this group was not different from that in mice treated with cyclophosphamide only ([Vijayalaxmi et al., 2004](#)).

(vi) Ultra-wide band EMF

Male CF1 mice were exposed for 15 minutes to ultra-wide band (UWB) electromagnetic fields (600 pulses per second) at an estimated whole-body average SAR of 37 mW/kg. The mice were killed at 18 hours or 24 hours after exposure, and peripheral blood and bone marrow were collected and examined for the presence of micronuclei in polychromatic erythrocytes. Under the experimental conditions of this study, there was no evidence of cytogenetic effects in blood or bone marrow of the exposed mice ([Vijayalaxmi et al., 1999](#)).

(c) Rat

See [Table 4.3](#)

(i) 834 MHz

Micronucleus formation was investigated in the offspring of rats exposed to RF radiation. Wistar rats were placed in experimental cages on the first day of pregnancy and exposed (8.5 hours per day) to RF radiation at 834 MHz (26.8–40 V/m; vertical polarization; peak power, 600 mW; calculated SAR, 0.55–1.23 W/kg) from an analogue mobile telephone that was placed close to the plexiglass cage. Exposure was continued throughout gestation. Newborn pups (age, 2 days) showed a statistically significant increase ($P < 0.003$) in micronucleus frequency in erythrocytes (1.23 ± 0.17 per 1000 cells) compared with controls (0.5 ± 0.1 per 1000 cells). Oxidative parameters measured in blood plasma or liver were not different between exposed and control rats ([Ferreira et al., 2006](#)).

(ii) 900–915 MHz

Wistar rats were exposed to RF radiation at 910 MHz (maximum SAR, 0.42 W/kg) for 2 hours per day on 30 consecutive days. Compared with non-exposed control rats, an almost threefold increase in the frequency of micronuclei was found in polychromatic erythrocytes of males and females ($P < 0.001$ and $P < 0.01$, respectively); the induction was significantly lower in females than in males ($P < 0.001$). An increase in micronucleus frequency was also observed in polymorphonuclear cells ([Demsia et al., 2004](#)).

Genotoxic effects of coexposure to RF radiation at 900 MHz with 3-chloro-4-(dichloromethyl)-5-hydroxy-2(5*H*)-furanone (MX, a by-product of water chlorination; 19 µg/ml in drinking-water) were investigated in female Wistar rats ([Verschaeve et al., 2006](#)). The rats were exposed to RF radiation for 2 hours per day, 5 days per week, for 2 years, at an average SAR of 0.3 or 0.9 W/kg; exposure to MX was continuous. Blood samples were collected at 3, 6 and 24

Table 4.3 Genetic and related effects of radiofrequency radiation, alone or in combination with chemical/physical mutagens: studies in experimental animals *in vivo*

End-point	Frequency	SAR	Duration	Chemical/physical mutagen	Results	Comments	References
<i>Mouse</i>							
MN formation in peripheral blood and bone-marrow cells in tumour-prone C3H/HeJ mice	2450 MHz, CW	1.0 W/kg	20 h/d, 7 d/wk, for 1.5 yr	None	+	Corrected statistical analysis in 1998 paper	Vijayalaxmi <i>et al.</i> (1997a, 1998)
MN formation in PCEs from peripheral blood and bone marrow of CF1 mice	Ultra-wide band radiation	0.037 W/kg	15 min	None	–		Vijayalaxmi <i>et al.</i> (1999)
MN formation in peripheral-blood and bone-marrow cells of male BALB/c mice	42 200 MHz	622 ± 100 W/kg	30 min/d for 3 consecutive days	Coexposure with cyclophosphamide	–	No effect of RF radiation alone; no effect on MN induced by cyclophosphamide	Vijayalaxmi <i>et al.</i> (2004)
MN formation in erythrocytes of blood or bone marrow, in keratinocytes and in spleen lymphocytes of B6C3F ₁ mice	900 MHz (GSM) and 1800 MHz (DCS); AM	3.7, 11 and 33.2 W/kg (1-wk study); and 2.8, 8.3 and 24.9 W/kg (6-wk study)	2 h/d during 1 or 6 wk	None	–		Görlitz <i>et al.</i> (2005)
MN formation in erythrocytes of female inbred CBA/S mice (taken from study by Heikkinen <i>et al.</i>, 2001)	902.5 MHz (NMT), CW or 902.5 MHz (GSM), PW	1.5 W/kg or 0.35 W/kg	1.5 h/d, 5 d/wk, for 78 wk	Also exposed to X-rays (3 × 1.33 Gy, during first 3 wk)	–	No effect of RF radiation alone; no effect on MN induced by X-rays	Juutilainen <i>et al.</i> (2007)
MN formation in erythrocytes of female K2 transgenic and non-transgenic mice (taken from Heikkinen <i>et al.</i>, 2003)	Digital mobile-phone signals, GSM at 849 MHz and DAMPS at 902 MHz	0.5 W/kg	1.5 h/d, 5 d/wk, for 52 wk	Also exposed to UV radiation (1.2 MED), 3×/wk	–	No effect of RF radiation alone; no effect on MN induced by UV	Juutilainen <i>et al.</i> (2007)
MN formation in erythrocytes of B6C3F ₁ /Cr1BR male and female mice	GSM (902 MHz) or DCS (1747 MHz)	0.4, 1.3 or 4.0 W/kg	2 h/d, 5 d/wk, for 2 yr	None	–	No difference in MN frequency in exposed, sham-exposed or cage-control mice	Ziemann <i>et al.</i> (2009)
Mutation assay (<i>lacI</i> transgene) in brain tissue of Big Blue mice	1500 MHz	0, 0.67, or 2 W/kg	90 min/d, 5 d/wk, for 4 wk	None	–		Takahashi <i>et al.</i> (2002)

Table 4.3 (continued)

End-point	Frequency	SAR	Duration	Chemical/physical mutagen	Results	Comments	References
Mutation frequency of the <i>lacZ</i> gene in cells from the spleen, liver, brain and testes of the offspring of <i>lacZ</i> - transgenic mice	2450 MHz (intermittent, 10 s on, 50 s off)	0.71 W/kg (average); 4.3 W/kg (for 10 s exposures)	Exposure <i>in utero</i> for 16 h/d on days 0–15 of gestation	None	–	Offspring was analysed at age 10 wk	Ono et al. (2004)
DNA microsatellite analysis with synthetic oligonucleotide probes in cells of brain and testis of Swiss albino mice	2450 MHz, CW	1.2 W/kg	2 h/d, for 120, 150, 200 d	None	+	Change in length of a microsatellite sequence	Sarkar et al. (1994)
DNA damage assessed by quantitative PCR (Q-PCR), alkaline- and pulsed-field electrophoresis in caudal epididymal spermatozoa of CD1 Swiss mice	900 MHz	0.09 W/kg	12 h/d, for 7 d	None	+	No effect on male germ-cell development; Q-PCR showed damage in mitochondrial genome and in nuclear β -globin locus	Aitken et al. (2005)
Somatic intrachromosomal recombination in spleen cells of pKZ1 transgenic mice	900 MHz, PW	4 W/kg	30 min/d for 1, 5, 25 d	None	–	Reduction in inversions below the spontaneous frequency in the group exposed for 25 d	Sykes et al. (2001)
<i>Rat</i>							
MN formation in peripheral-blood and bone-marrow cells of male Sprague-Dawley rats	2450 MHz, CW	12 W/kg	24 h	None	–		Vijayalaxmi et al. (2001a)
MN formation in peripheral blood cells of male Wistar rats	2450 MHz, CW	1 and 2 W/kg	2 h/d for up to 30 d	None	+	Only after 8 (not 2, 15, or 30) exposures of 2 h each	Trosic et al. (2002)
MN formation in PCEs in bone marrow and peripheral blood of Wistar rats	2450 MHz	Whole-body SAR, 1.25 W/kg	2 h/d, 7 d/wk, 30 d	None	+	Increased MN frequency in PCEs in bone marrow on day 15, and in the peripheral blood on day 8	Trosic & Busljeta (2006)
MN formation in bone-marrow cells of male and female Wistar rats	910 MHz	Peak SAR, 0.42 W/kg	2 h/d for 30 consecutive days	None	+		Demsia et al. (2004)

Table 4.3 (continued)

End-point	Frequency	SAR	Duration	Chemical/physical mutagen	Results	Comments	References
MN formation in bone-marrow cells of male Wistar rats	2450 MHz, CW	1.25 W/kg	2 h/d for up to 30 days (total exposure 4, 16, 30 or 60 h)	None	+	Increase in PCE in bone marrow on day 15 (exposure, 30 h). Transient effect on proliferation and maturation of erythropoietic cells	Trosic et al. (2004) ; Busljeta et al. (2004)
MN formation in blood from adult pregnant Wistar rats	834 MHz, mobile-phone antenna, 26.8–40 V/m	0.55–1.23 W/kg	From day 1 of gestation, for 8.5 h/d, until birth of offspring	None	+	Significant increase of MN frequency in erythrocytes of newborn pups exposed <i>in utero</i>	Ferreira et al. (2006)
MN formation in blood of female Wistar rats	900 MHz, AM	0.3 and 0.9 W/kg	2 h/d, 5 d/wk, for 2 yr	Coexposure with MX in drinking-water	–	No increase in MN after coexposure to MX and RF radiation compared with MX [no group exposed to RF only]	Verschaeve et al. (2006)
MN formation in blood cells of Wistar rats	10 000 MHz 50 000 MHz	0.04 W/kg 0.0008 W/kg	2 h/d for 45 d	None	+ +	Also significant increase of ROS in serum	Kumar et al. (2010)
DNA breaks (SSB, DSB) measured with comet assay in brain cells of male Sprague-Dawley rats	2450 MHz, PW or CW	0.6 and 1.2 W/kg	2 h	None	+	Significant and SAR-dependent increase in SB immediately and at 4 h after exposure to CW; only at 4 h after exposure to PW	Lai & Singh (1995)
DNA breaks (SSB, DSB) measured with comet assay in brain cells of male Sprague-Dawley rats	2450 MHz, PW or CW	1.2 W/kg	2 h	None	+	Significant increase in SB at 4 h after exposure to either PW or CW	Lai & Singh (1996)
DNA breaks (SSB, DSB) measured with comet assay in brain cells of male Sprague-Dawley rats	2450 MHz, PW	1.2 W/kg	2 h	Melatonin or <i>N</i> -tert-butyl- α -phenylnitron (free-radical scavengers)	+	Significant increase in SB at 4 h after exposure. Treatment with radical scavengers before and after exposure to RF prevented/reversed induction of SB	Lai & Singh (1997)

Table 4.3 (continued)

End-point	Frequency	SAR	Duration	Chemical/physical mutagen	Results	Comments	References
DNA breaks (SSB) measured with comet assay in brain cells of male Sprague-Dawley rats	2450 MHz, CW	1.2 W/kg	2 h	None	-		Malyapa et al. (1998)
DNA breaks (SSB) measured with alkaline comet assay (with or without proteinase K) in brain cells of male Sprague-Dawley rats	2450 MHz, PW	1.2 W/kg	2 h	None	-		Lagroye et al. (2004a)
DNA breaks (SSB, DSB) measured with comet assay in brain cells of male Sprague-Dawley rats	2450 MHz, CW, circular polarization	0.6 W/kg	2 h	None	+	Significant increase in SB at 4 h after exposure	Lai & Singh (2005)
DNA breaks (DSB) measured with pulsed-field electrophoresis. Changes in chromatin conformation detected with AVTD assay in brain cells from Wistar rats	915 MHz (GSM)	0.4 W/kg	2 h	None	-	Changes in gene expression were detected	Belyaev et al. (2006)
DNA breaks (SSB) measured with alkaline comet assay in brain cells of male and female Wistar rats	2450 MHz or 16 500 MHz	1.0 W/kg or 2.01 W/kg	2 h/d, for 35 d	None	+	DNA breakage was observed at both frequencies	Paulraj & Behari (2006)
DNA breaks (SSB) measured with alkaline comet assay in blood, liver and brain of female Wistar rats	900 MHz, AM	0.3 or 0.9 W/kg	2 h/d, 5 d/wk for 2 yr	Co-exposure with MX in drinking-water	-	No increase in SB after co-exposure to MX and RF radiation compared with MX [no group exposed to RF only]	Verschaeve et al. (2006)
DNA breaks (DSB) measured with neutral comet assay in brain of male Wistar rats	2450 MHz, from MW oven	0.11 W/kg (whole-body)	2 h/d, 35 d	None	+	Highly significant decrease in anti-oxidant enzymes and increase in catalase were also seen ($P < 0.006$)	Kesari et al. (2010)

Table 4.3 (continued)

End-point	Frequency	SAR	Duration	Chemical/physical mutagen	Results	Comments	References
<i>Rabbit</i>							
Oxidative DNA damage (8-OHdG) in liver of pregnant and non-pregnant New Zealand White rabbits	1800 MHz (GSM-like)	NR	15 min/d for 1 wk (for pregnant rabbits: days 15–22 of gestation)	None	–	No difference in 8-OHdG/10 ⁶ dG between exposed and sham-exposed non-pregnant or pregnant rabbits, or between newborns exposed <i>in utero</i> and sham-exposed newborns	Tomruk et al. (2010)
<i>Cow</i>							
MN formation in erythrocytes of Latvian Brown cows living in the Skrunda radio-station area	154–162 MHz, PW	NR	Cows had been living in the area for at least 2 yr	None	+	Significant increase in MN compared with cows in a control area. Frequencies of MN were low in all cases	Balode (1996)

+, increase; –, no effect; AVTD, anomalous viscosity time-dependence; CW, continuous wave; d, day; DAMPS, Digital Advanced Mobile Phone System, DCS, Digital Cellular System; DSB, DNA double-strand breaks; GSM, Global System for Mobile Communications; h, hour; MED, minimal erythema dose; min, minute; MN, micronuclei; MW, microwave; MX, 3-chloro-4-(dichloromethyl)-5-hydroxy-2(5H)-furanone; NMT, Nordic Mobile Telephone; NR, not reported; PCE, polychromatic erythrocytes; PW, pulsed wave; s, second; SAR, specific absorption rate; SB, DNA strand breaks, SSB, DNA single-strand breaks; wk, week; yr, year

months and brain and liver samples were taken at the end of the study (24 months). The extent of DNA strand breaks in blood, liver and brain cells was determined by means of the alkaline comet assay; the frequency of micronuclei was measured in erythrocytes. Coexposure to MX and RF radiation did not significantly change the effects in blood, liver and brain cells compared with those seen with MX only [the Working Group noted that this study did not include a treatment group exposed to RF radiation only].

Induction of DNA double-strand breaks was measured by means of pulsed-field gel electrophoresis, and changes in chromatin conformation were assessed by use of the anomalous viscosity time-dependence (AVTD) assay in brain tissue of Fisher rats exposed to RF radiation at 915 MHz (GSM; SAR, 0.4 W/kg) for 2 hours. No effects of exposure to RF radiation were found. Analysis of gene-expression profiles in the cerebellum of exposed rats revealed changes in genes associated with neurotransmitter regulation, melatonin production and regulation of the blood-brain barrier ([Belyaev et al., 2006](#)).

(iii) 1600 MHz

Timed-pregnant Fischer 344 rats were exposed from day 19 of gestation, and their nursing offspring until weaning at 3 weeks of age, to far-field RF radiation at 1600 MHz (iridium wireless-communication signal) for 2 hours per day, 7 days per week. The whole-body average SAR was 0.036–0.077 W/kg (0.10–0.22 W/kg in the brain). This first exposure was followed by long-term, head-only exposures of male and female offspring (starting at age 35 days) to a near-field 1600 MHz signal, with a SAR of 0.16 or 1.6 W/kg in the brain, for 2 hours per day, 5 days per week, for 2 years. The micronucleus frequency in polychromatic erythrocytes of the bone marrow was not significantly different between exposed, sham-exposed and cage-control rats ([Vijayalaxmi et al., 2003](#)).

(iv) 2450 MHz

In several publications from the same laboratory it was reported that brain cells of male Sprague-Dawley rats exposed for 2 hours to low-intensity pulsed-wave or continuous-wave RF radiation at 2450 MHz (SAR, 0.6 or 1.2 W/kg) showed an increased number of DNA single- and double-strand breaks – measured by the neutral and alkaline comet assays – at 4 hours after exposure. The authors suggested that this could be due either to a direct effect on DNA or to an effect on DNA repair ([Lai & Singh, 1995, 1996](#)). In subsequent experiments, treatment of the rats with free-radical scavengers appeared to block this effect of RF exposure, suggesting that free radicals may be involved in RF-radiation-induced DNA damage in the rat brain ([Lai & Singh, 1997](#)).

Male Sprague-Dawley rats were exposed to continuous-wave RF radiation at 2450 MHz (SAR of 1.2 W/kg) for 2 hours, which did not cause a rise in the core body-temperature of the rats. One group of rats was killed by carbon dioxide (CO₂) asphyxia, another by decapitation. DNA breakage was assessed by means of the alkaline comet assay. No significant differences were observed in the comet length or the normalized comet moment of cells isolated from either the cerebral cortex or the hippocampus of irradiated rats and those from sham-exposed rats. This was independent of the method by which the rats were killed. However, there was more intrinsic DNA damage and more experiment-to-experiment variation in cells from the asphyxiated rats than from rats killed by decapitation. Therefore, the latter method appeared to be the most appropriate in this type of study ([Malyapa et al., 1998](#)). [The Working Group noted that this study was not a valid replication of the [Lai & Singh \(1995\)](#) study, contrary to the authors' intention, but it provided independent evidence contrary to those results. The Working Group also noted that the increased number of DNA strand breaks after

exposure to RF radiation *in vivo* was particularly protocol-dependent, specifically with respect to the method of killing the animals and the treatment of tissue samples between exposure of the animals and analysis of the tissues.]

[Vijayalaxmi et al. \(2001a\)](#) found no evidence for the induction of micronuclei in peripheral-blood and bone-marrow cells of Wistar rats exposed continuously to continuous-wave RF radiation at 2450 MHz, with an average whole-body SAR of 12 W/kg, for 24 hours.

[Lagroye et al. \(2004a\)](#) investigated the induction of DNA damage in brain cells of Sprague-Dawley rats exposed to pulsed-wave RF radiation at 2450 MHz, with a SAR of 1.2 W/kg, for 2 hours. The rats were decapitated 4 hours after exposure. No DNA damage was detected in separate samples of the same brain-cell preparation from exposed rats, assessed by two variants of the alkaline comet assay.

Wistar rats were exposed to non-thermal RF radiation at 2450 MHz for 2 hours per day on 7 days per week, for up to 30 days. The power-density range was 5–10 mW/cm², which corresponded to an approximate SAR of 1–2 W/kg. Erythrocyte counts, haemoglobin concentrations and haematocrit values were significantly increased in peripheral blood on days 8 and 15, and anuclear cells and erythropoietic precursor cells in bone marrow were significantly decreased. The frequency of micronucleated cells in the bone marrow was significantly increased on day 15, not on days 2, 8, and 30 ([Busljeta et al., 2004](#)).

Adult male Wistar rats were exposed to continuous-wave RF radiation at 2450 MHz for 2 hours per day, 7 days per week, for up to 30 days. The power-density range was 5–10 mW/cm², which corresponded to an approximate SAR of 1–2 W/kg. The frequency of micronuclei in polychromatic erythrocytes was significantly increased in the group that had received 8 irradiation treatments of 2 hours each, but not in the groups that received 2, 15 or 30 treatments, in comparison with the sham-exposed group.

These results would be in line with an adaptive or recovery mechanism that was triggered in this experimental model during treatment ([Trosic et al., 2002, 2004](#)). Similar results were presented in a later publication ([Trosic & Busljeta, 2006](#)).

[Paulraj & Behari \(2006\)](#) reported a significantly increased ($P < 0.001$) level of DNA breakage – measured by means of the alkaline comet assay – in brain cells of rats exposed to RF radiation at 2450 MHz or 16.5 GHz (SAR, 1.0 or 2.01 W/kg) for 2 hours per day, for 35 days.

Wistar rats were exposed to RF radiation at 2450 MHz (power density, 0.34 mW/cm²) for 2 hours per day, for 35 days. The whole-body SAR was estimated to be 0.11 W/kg. After exposure, rats were killed and whole-brain tissue was dissected and used for analysis of DNA double-strand breaks by means of the neutral comet assay. A significant increase was observed in various comet parameters in exposed brain cells compared with controls. Statistically significant changes were also observed in the levels of different antioxidant enzymes, *i.e.* a decrease in glutathione peroxidase, superoxide dismutase and histone kinase, and an increase in catalase ([Kesari et al., 2010](#)).

(v) 10–50 GHz

Wistar rats were exposed continuously to RF radiation at 10 GHz or 50 GHz (SAR, 0.014 W/kg and 0.0008 W/kg, respectively) for 2 hours per day, for 45 days. In both cases, significant increases ($P < 0.05$) in the frequency of micronuclei – deduced from a reduced polychromatic/normochromatic erythrocyte ratio – and in concentrations of reactive oxygen species (ROS) were found in blood cells and serum, respectively ([Kumar et al., 2010](#)).

(d) Rabbit

A study was performed with non-pregnant and pregnant New Zealand White rabbits. The rabbits were exposed (whole-body) to 1800 MHz RF radiation (GSM) for 15 minutes per day,

for 1 week. For the pregnant rats, this exposure period was between day 15 and day 22 of gestation. Control groups of non-pregnant and pregnant rabbits were sham-exposed. No difference was found in the level of 8-hydroxy-2'-deoxyguanosine (an indicator of oxidative DNA damage; expressed as 8-OHdG/10⁶ dG) in DNA from liver tissue of exposed and sham-exposed rabbits (pregnant or non-pregnant). Changes in malondialdehyde concentration and ferrous oxidation in xylenol orange in the liver of exposed non-pregnant and pregnant rabbits indicated an effect on lipid peroxidation. In pups exposed *in utero*, a reduction in ferrous oxidation in xylenol orange was seen in the liver, but no change was observed in malondialdehyde concentration. These results supported the notion that 1800 MHz GSM-like RF radiation may induce oxidative stress in exposed tissues ([Tomruk et al., 2010](#)).

(e) Cow

Blood samples were obtained from 67 female Latvian Brown cows living on a farm in the vicinity of the Skrunda radio-location station (Latvia), and from 100 cows in a control area, which was selected on the basis of the similarity to the exposed area with regards to many factors except exposure. Frequencies of micronuclei were scored in the erythrocytes and found to be low but statistically significantly increased in the exposed cows compared with those in the controls (0.6/1000 cells compared with 0.1/1000 cells; $P < 0.01$) ([Balode, 1996](#)).

4.1.3 Experimental systems: *in vitro*

(a) Humans: peripheral blood lymphocytes

The most widely used cell type for investigations *in vitro* is the peripheral blood lymphocyte. Some details on the exposure conditions to RF radiation and a short conclusion of the publications discussed below are presented in [Table 4.4](#).

(i) Studies with a single end-point

DNA-damage induction and repair

The effects of exposure to RF radiation at frequencies ranging from approximately 800 to 8000 MHz were examined by several investigators, who reported no significant effect on induction of DNA strand breaks ([Baohong et al., 2005, 2007](#); [Chemeris et al., 2006](#); [Sannino et al., 2006](#)).

[Vijayalaxmi et al. \(2000\)](#) assessed DNA strand breaks in human lymphocytes and also the capacity of these cells to repair such damage after exposure to RF radiation at 2450 MHz, and observed no effect on either parameter. [Zhijian et al. \(2009\)](#) also reported no effect of exposure to RF radiation at 1800 MHz, not only on induction of DNA strand breaks but also on the repair kinetics of X-irradiation-induced DNA strand breaks. [Tiwari et al. \(2008\)](#) exposed human lymphocytes to RF radiation at 835 MHz (SAR, 1.17 W/kg) and subsequently incubated the cells in the presence of aphidicolin (APC; an inhibitor of DNA repair) at a dose of 0.02 or 2 µg/ml. There was no effect on DNA strand breakage from exposure to RF radiation alone. APC (2 µg/ml) and combinations of RF radiation with APC (0.02 and 2 µg/ml) enhanced the number of DNA strand breaks; this damage is repairable (see Section 4.1.3c).

Chromosomal aberrations

[Maes et al. \(1995\)](#) found an increase in the frequency of chromosomal aberrations in the form of dicentrics and acentric fragments in human lymphocytes exposed to pulsed-wave RF radiation at 954 MHz, while using a cooled box to maintain the temperature at 17 ± 1 °C. [Manti et al. \(2008\)](#) carried out FISH analysis with molecular probes specific for whole chromosomes 1 and 2 in lymphocytes from four donors. The cells were exposed to RF radiation at 1950 MHz (UMTS, Universal Mobile Telecommunications System) at SAR 0.5 or 2.0 W/kg, for 24 hours. There was no effect on the fraction of aberrant cells at a

Table 4.4 Genetic and related effects in human peripheral blood lymphocytes exposed to radiofrequency radiation *in vitro*

End-point	Frequency	SAR or power density	Duration	Results	Comments	Reference
Aneuploidy	830 MHz, CW	2.0–8.2 W/kg	72 h	+ (chromosome 17)	Temperature kept at 33.5–37.5 °C. In control without RF, no aneuploidy was seen up to 38.5 °C	Mashevich et al. (2003)
Aneuploidy	100 GHz, CW	0.31 mW/cm ²	1–24 h	+ (chromosomes 11, 17) – (chromosomes 1, 10)	Direct effect questionable. High values in control cells.	Korenstein-Ilan et al. (2008)
Aneuploidy	800 MHz, CW	2.9, 4.1 W/kg	24 h	+ (chromosomes 11, 17) at SAR of 2.9 W/kg + (chromosomes 1, 10) at SAR of 4 W/kg	High values in control cells. In control without RF, no aneuploidy was seen up to 40 °C	Mazor et al. (2008)
Chromosomal aberration	7700 MHz, CW	0.5, 10, 30 mW/cm ²	10, 30, 60 min	+	Abberations increased at 10 and 30 mW/cm ² at all time-points	Garaj-Vrhovac et al. (1992)
Chromosomal aberration	2450 MHz, PW	75 W/kg	30 min, 2 h	+	MW output was adjusted with a thermistor to keep cells at 36.1 °C	Maes et al. (1993)
Chromosomal aberration	954 MHz, PW; GSM	1.5 W/kg	2 h	±	Questionable dosimetry (pylon from GSM base-station connected to indoor antenna); no statistics provided	Maes et al. (1995)
Chromosomal aberration	440, 900, 1800 MHz, PW; GSM	1.5 W/kg	30–72 h	–		Eberle et al. (1996)
Chromosomal aberration	935.2 MHz, PW; GSM	0.3–0.4 W/kg	2 h	–		Maes et al. (1997)
Chromosomal aberration	2450 MHz, CW	12.5 W/kg	90 min or 3 × 30 min	–		Vijayalaxmi et al. (1997b)
Chromosomal aberration	455.7 MHz, PW	6.5 W/kg	2 h	–	Cells were placed 5 cm from a car phone	Maes et al. (2000)
Chromosomal aberration	900 MHz, PW; CDMA	0.4–10 W/kg	2 h	–		Maes et al. (2001)
Chromosomal aberration	835.62 MHz, CW; FDMA	4.4, 5.0 W/kg	24 h	–		Vijayalaxmi et al. (2001a)
Chromosomal aberration	847.74 MHz, CW; CDMA	4.9, 5.5 W/kg	24 h	–		Vijayalaxmi et al. (2001b)
Chromosomal aberration	2500 MHz 10 500 MHz	627 W/kg 0.25 W/kg	40 s 5 min	– –	MW oven at 3 W	Figueiredo et al. (2004)

Table 4.4 (continued)

End-point	Frequency	SAR or power density	Duration	Results	Comments	Reference
Chromosomal aberration	900 MHz, PW; GSM	0.3, 1 W/kg	2 h	-		Zeni et al. (2005)
Chromosomal aberration	935 MHz, PW; GSM	1, 2 W/kg	24 h	-		Stronati et al. (2006)
Chromosomal aberration	2450, 8200 MHz, PW	2.1, 21 W/kg	2 h	-		Vijayalaxmi et al. (2006)
Chromosomal aberration	1950 MHz, PW; UMTS	0.5, 2 W/kg	24 h	- at SAR of 0.5 W/kg + at SAR of 2 W/kg	Frequency of aberrations/cell was increased at higher SAR; FISH technique was used	Manti et al. (2008)
Chromosomal aberration	18 000 MHz, CW 16 500 MHz, PW	1 mW/cm ² 10 mW/cm ²	53 h	-		Hansteen et al. (2009a)
Chromosomal aberration	2300 MHz, CW, PW	1 mW/cm ²	53 h	-		Hansteen et al. (2009b)
Micronucleus formation	7700 MHz, CW	0.5, 10, 30 mW/cm ²	10, 30, 60 min	+	MN frequency increased at 30 mW/cm ² , after 30 and 60 min of exposure	Garaj-Vrhovac et al. (1992)
Micronucleus formation	2450 MHz, PW	75 W/kg	30 min, 2 h	+	MW output was adjusted with a thermistor to keep cells at 36.1 °C	Maes et al. (1993)
Micronucleus formation	9000 MHz, CW, PW	90 W/kg	10 min	+ with PW - with CW	Temperature during exposure was 30–35 °C. Control cultures were kept at 37 °C	d'Ambrosio et al. (1995)
Micronucleus formation	440, 900, 1800 MHz, PW; GSM	1.5 W/kg	30–72 h	-		Eberle et al. (1996)
Micronucleus formation	2450 MHz, CW	12.5 W/kg	3 × 30 min	-		Vijayalaxmi et al. (1997b)
Micronucleus formation	2450, 7700 MHz, CW	10, 20, 30 mW/cm ²	15, 30, 60 min	+	Experiment carried out at 20–22 °C. Temperature-control measurements were made in water	Zotti-Martelli et al. (2000)
Micronucleus formation	835.62 MHz, CW; FDMA	4.4, 5.0 W/kg	24 h	-		Vijayalaxmi et al. (2001a)
Micronucleus formation	847.74 MHz, CW; CDMA	4.9, 5.5 W/kg	24 h	-		Vijayalaxmi et al. (2001b)
Micronucleus formation	1748 MHz, CW, PW; GSM	5 W/kg	15 min	+ with PW - with CW	Temperature during exposure was 30–35 °C. Control cultures were kept at 37 °C	d'Ambrosio et al. (2002)
Micronucleus formation	1900 MHz, CW, PW	0.1–10 W/kg	2 h	-		McNamee et al. (2002a)

Table 4.4 (continued)

End-point	Frequency	SAR or power density	Duration	Results	Comments	Reference
Micronucleus formation	2450 MHz, PW	5 mW/cm ²	2 h	-		Zhang et al. (2002)
Micronucleus formation	837, 1909 MHz, CW, PW; CDMA, TDMA	1.0, 2.5, 5.0, 10.0 W/kg	3 h, 24 h	+ after 24 h, at SARs of 5 or 10 W/kg	Some exposures were from mobile telephones. Temperature variations were ± 0.3 °C and ± 0.5 °C at 3 h and 24 h, respectively. EMS was included as a positive control	Tice et al. (2002)
Micronucleus formation	1900 MHz, CW, PW	0.1–10 W/kg	24 h	-		McNamee et al. (2003)
Micronucleus formation	120, 130 GHz PW	1 and 0.6 mW average power	20 min	-		Scarfi et al. (2003)
Micronucleus formation	900/925 MHz, CW, PW(i); GSM	1.6 W/kg 0.2 W/kg	14 \times (6 min on, 3 h off) at 1.6 W/kg; 1 h/d for 3 d at 0.2 W/kg	-		Zeni et al. (2003)
Micronucleus formation	1800 MHz, CW	5, 10, 20 mW/cm ²	1, 2, 3 h	+	Large variation between individuals and repeat experiments	Zotti-Martelli et al. (2005)
Micronucleus formation	900 MHz, PW; GSM	0.1–10 W/kg	24 h	-	Concordant results between two research groups in interlaboratory study	Scarfi et al. (2006)
Micronucleus formation	935 MHz, PW; GSM	1, 2 W/kg	24 h	-		Stronati et al. (2006)
Micronucleus formation	2450, 8200 MHz, PW	2.1, 21 W/kg	2 h	-		Vijayalaxmi et al. (2006)
Micronucleus formation	1950 MHz, PW (c, i); UMTS	0.05–2 W/kg	4–48 h	-	Controversial data	Schwarz et al. (2008)
Micronucleus formation	1950 MHz, PW (c, i); UMTS	2.2 W/kg	24–68 h	-		Zeni et al. (2008)
Micronucleus formation	900 MHz, PW; GSM	1.25 W/kg	20 h	-	No effect of RF radiation alone. Reduction of MMC-induced micronucleus frequency. Data indicative of an adaptive response	Sannino et al. (2009a)
Sister-chromatid exchange	2450 MHz, PW	75 W/kg	30 min, 2 h	-	MW output was adjusted with a thermistor to keep cells at 36.1 °C	Maes et al. (1993)
Sister-chromatid exchange	954 MHz, PW; GSM	1.5 W/kg	2 h	-		Maes et al. (1996)

Table 4.4 (continued)

End-point	Frequency	SAR or power density	Duration	Results	Comments	Reference
Sister-chromatid exchange	380, 900, 1800 MHz, PW; TETRA, DCS, GSM	0.08–1.7 W/kg	72 h	-		Antonopoulos et al. (1997)
Sister-chromatid exchange	440, 900, 1800 MHz, PW; GSM	1.5 W/kg	30–72 h	-		Eberle et al. (1996)
Sister-chromatid exchange	935.2 MHz, PW; GSM	0.3–0.4 W/kg	2 h	-		Maes et al. (1997)
Sister-chromatid exchange	455.7 MHz, PW; car phone	6.5 W/kg	2 h	-		Maes et al. (2000)
Sister-chromatid exchange	900 MHz, PW; GSM	0.4–10 W/kg	2 h	-		Maes et al. (2001)
Sister-chromatid exchange	900 MHz, PW; GSM	0.3, 1 W/kg	2 h	-		Zeni et al. (2005)
Sister-chromatid exchange	400–900 MHz, PW	-	-	-		Maes et al. (2006)
Sister-chromatid exchange	935 MHz, PW; GSM	1, 2 W/kg	24 h	-		Stronati et al. (2006)
DNA single- and double-strand breaks	935.2 MHz, PW; GSM	0.3–0.4 W/kg	2 h	-		Maes et al. (1997)
DNA single- and double-strand breaks	2450 MHz, PW	2.1 W/kg	2 h	-	No effect, immediately or 4 h after exposure	Vijayalaxmi et al. (2000)
DNA single- and double-strand breaks	1900 MHz, CW, PW	0.1–10 W/kg	2 h	-		McNamee et al. (2002a)
DNA single- and double-strand breaks	2450 MHz, PW	5 mW/cm ²	2 h	-		Zhang et al. (2002)
DNA single- and double-strand breaks	837, 1909 MHz, CW, PW; CDM, TDM	1.0, 2.5, 5.0, 10.0 W/kg	3 h, 24 h	-	Some exposures were from mobile telephones. Temperature variations were ± 0.3 °C and ± 0.5 °C at 3 h and 24 h, respectively. EMS was included as a positive control.	Tice et al. (2002)
DNA single- and double-strand breaks	1900 MHz, CW, PW	0.1–10 W/kg	24 h	-		McNamee et al. (2003)

Table 4.4 (continued)

End-point	Frequency	SAR or power density	Duration	Results	Comments	Reference
DNA single- and double-strand breaks	1800 MHz, PW; GSM	3 W/kg	2 h	-		Baohong et al. (2005)
DNA single- and double-strand breaks	900 MHz, PW; GSM	0.3, 1 W/kg	2 h	-		Zeni et al. (2005)
DNA single- and double-strand breaks	8800 MHz, PW	1.6 kW/kg	40 min	-		Chemeris et al. (2006)
DNA single- and double-strand breaks	1950 MHz, PW; UMTS	0.5, 2 W/kg	24 h	-		Sannino et al. (2006)
DNA single- and double-strand breaks	935 MHz, PW; GSM	1, 2 W/kg	24 h	-		Stronati et al. (2006)
DNA single- and double-strand breaks	1800 MHz, PW; GSM	3 W/kg	1.5, 4 h	-		Baohong et al. (2007)
DNA single- and double-strand breaks	120 000, 130 000 MHz, PW; THz	0.2–2 W/kg	20 min	-		Zeni et al. (2007a)
DNA single- and double-strand breaks	1950 MHz, PW(c, i); UMTS	0.05–2 W/kg	4–48 h	-	Controversial data	Schwarz et al. (2008)
DNA single- and double-strand breaks	835 MHz, PW; CDMA	1.17 W/kg	1 h	-	RF radiation induced repairable DNA damage in the presence of aphidicolin	Tiwari et al. (2008)
DNA single- and double-strand breaks	1950 MHz, PW(c, i); UMTS	2 W/kg	24–68 h	-		Zeni et al. (2008)
DNA single- and double-strand breaks	1800 MHz, PW(i); GSM	2 W/kg	24 h	-	No effect of RF radiation on repair of X-ray-induced DNA damage	Zhijian et al. (2009)
Mutation at <i>HPRT</i> locus	440, 900, 1800 MHz, PW; GSM	1.5 W/kg	30–72 h	-		Eberle et al. (1996)

Table 4.4 (continued)

End-point	Frequency	SAR or power density	Duration	Results	Comments	Reference
Foci	915 MHz, PW; GSM	37 mW/kg	2 h	+	Decrease in 53BP1-foci (measured by immuno-staining); enhanced chromatin condensation (measured by AVTD)	Belyaev et al. (2005)
Foci	905, 915 MHz, PW; GSM	37 mW/kg	1 h	+ at 915 MHz - at 905 MHz	Decrease in 53BP1- and γ -H2AX-foci (measured by immunostaining) and enhanced chromatin condensation (measured by AVTD)	Markovà et al. (2005)
Foci	905, 915, 1947 MHz, PW; GSM, UMTS	0.015–0.145 W/kg	1 h	+ at 915 MHz - at 905 MHz + t 1947 MHz	Decrease in 53BP1- and γ -H2AX-foci (measured by immunostaining) and enhanced chromatin condensation (measured by AVTD). Strongest effect at 1947 MHz	Belyaev et al. (2009)

+, increase; \pm , equivocal; -, no effect; APC, aphidicholin (inhibitor of DNA repair); AVTD, anomalous viscosity time-dependence; (c, i): continuous or intermittent exposure; CA, chromosomal aberration; CDMA, code-division multiple access; CW, continuous wave; d, day; DCS, Digital Communication System; EMS, ethylmethane sulfonate; FDMA, frequency-division multiple access; FISH, fluorescence *in situ* hybridization; GSM, Global System for Mobile Communication; h, hour; HPRT, hypoxanthine(guanine)phosphoribosyl transferase; min, minute; MMC, mitomycin C; MW, microwave; PW, pulsed wave; s, second; TDMA, time-division multiple access; TETRA, Trans European Trunked Radio; THz; teraHertz; UMTS, Universal Mobile Telecommunication System

SAR of 0.5 W/kg, while there was a small but statistically significant increase in the frequency of aberrations per cell at 2 W/kg. [Figueiredo et al. \(2004\)](#) and [Hansteen et al. \(2009a, b\)](#) carried out conventional analyses of chromosomal aberrations on Giemsa-stained slides prepared with lymphocytes exposed to RF radiation at 1800–10 500 MHz, and observed no effect.

Micronucleus formation

[Zotti-Martelli et al. \(2000\)](#) exposed whole blood from two volunteers to continuous-wave RF radiation at 2450 MHz or 7700 MHz, with power densities of 10, 20 and 30 mW/cm² for 15, 30, and 60 minutes, and reported an increased micronucleus frequency in exposed cells at 30 mW/cm². In a subsequent study, [Zotti-Martelli et al. \(2005\)](#) observed an increase in the frequency of micronuclei in lymphocytes from nine different donors after exposure to RF radiation at 1800 MHz. This experiment was repeated after 3 months; there was significant variation between experiments. [The Working Group noted that temperature variation in the first study was not measured in blood samples during exposure, and the increased frequency of micronucleus formation may have been related to heating of the blood samples. Also, there were discrepancies between the data on micronuclei given in the text, figures, and tables]. [d'Ambrosio et al. \(1995, 2002\)](#) reported an increase in the formation of micronuclei in lymphocytes exposed to pulsed-wave RF radiation at 1748 MHz or 9000 MHz for 15 and 10 minutes, respectively, while no such increase was observed in cells exposed to continuous-wave RF at the same frequencies. [Zeni et al. \(2003\)](#) observed no significant effect on micronucleus formation in lymphocytes exposed to continuous or pulsed-wave RF radiation at 900 MHz (GSM). [Scarfi et al. \(2003\)](#) reported no micronucleus induction in lymphocytes exposed to continuous-wave RF radiation at 120–130 GHz. [Sannino et al. \(2009a\)](#) reported that a 20-hour pre-exposure of peripheral blood lymphocytes in the S-phase of the cell

cycle to pulsed-wave RF radiation at 900 MHz decreased the micronucleus frequency induced by mitomycin C (MMC), suggesting the existence of an adaptive response (see [Table 4.4](#) for details).

Sister-chromatid exchange (SCE)

[Maes et al. \(1996\)](#) did not find an effect on SCE in lymphocytes exposed to pulsed-wave RF radiation at 954 MHz, with a SAR of 1.5 W/kg, for 2 hours. Likewise, [Antonopoulos et al. \(1997\)](#) did not find an effect on SCE in lymphocytes exposed to RF radiation at 380–1800 MHz, with a SAR of 0.08–1.7 W/kg, for 72 hours.

Phosphorylation of histone protein H2AX and TP53-binding protein 53BP1

Over the past decade, several studies have demonstrated that two cellular check-point proteins, H2AX and TP53-binding protein 53BP1 are rapidly phosphorylated after induction of DNA damage in the form of double-strand breaks. These proteins then congregate to provide a scaffold structure to the repair sites ([Paull et al., 2000](#); [Schultz et al., 2000](#); [DiTullio et al., 2002](#); [Fernandez-Capetillo et al., 2002, 2004](#); [Sedelnikova et al., 2002](#); [Ismail et al., 2007](#)). By use of specific antibodies with fluorescent tags, γ -H2AX – the phosphorylated form of H2AX – and 53BP1 can be visualized as discrete foci, which can be counted directly with a fluorescence microscope.

The AVTD assay is used to detect stress-induced changes in chromatin conformation. [Shckorbatov et al. \(1998, 2009\)](#) and [Sarimov et al. \(2004\)](#) have reported changes in chromatin condensation in human lymphocytes exposed to RF radiation at 42.2 GHz, 35 GHz or 895–915 MHz, respectively, which prevented access of proteins involved in repair of DNA double-strand breaks. [Belyaev et al. \(2005\)](#) exposed human lymphocytes for 2 hours to pulsed-wave RF radiation at 915 MHz (GSM), with a SAR of 37 mW/kg, and reported significant

effects on chromatin condensation and a distinct reduction in the number of 53BP1-foci in samples from all individuals; these results were similar to those found after heat-shock treatment. The overall data suggested a reduced accessibility of 53BP1 to repair DNA double-strand breaks due to chromatin condensation. [Marková *et al.* \(2005\)](#) exposed human lymphocytes to pulsed-wave RF radiation at 905 MHz or 915 MHz (GSM), with a SAR of 37 mW/kg, for 1 hour. Chromatin condensation and decreased numbers of 53BP1- and γ -H2AX-foci were observed in cells after exposure at 915 MHz, but not at 905 MHz. The response was similar in healthy subjects and in subjects hypersensitive to RF radiation. [Belyaev *et al.* \(2009\)](#) exposed lymphocytes to pulsed-wave RF radiation at 905 MHz or 915 MHz (GSM), or 1947 MHz (UMTS), with a SAR of 15–145 mW/kg, for 1 hour. Chromatin condensation and reduction in numbers of 53BP1- and γ -H2AX-foci were much more pronounced in cells after exposure at 1947 MHz than at 915 MHz; there were no such effects after exposure at 905 MHz. The decrease in number of foci persisted for up to 72 hours after exposure, suggesting that not only the formation of double-strand breaks was affected, but also their repair. [Marková *et al.* \(2010\)](#) used VH10 primary fibroblasts established from human foreskin and mesenchymal stem cells isolated from adipose tissue of two healthy persons. These cells were exposed to pulsed-wave RF radiation at 905 MHz or 915 MHz (GSM; SAR, 37 mW/kg), or at 1947 MHz (UMTS; SAR, 39 mW/kg), as a single exposure for 1, 2 or 3 hours, or as repeated exposures for 1 hour per day, 5 days per week, for 2 weeks. The decrease in the number of 53BP1-foci was more pronounced in stem cells than in foreskin fibroblasts, and the stem cells did not adapt to long-term exposure to RF radiation.

Aneuploidy

Peripheral blood lymphocytes from five individuals were stimulated with phytohemagglutinin (PHA) and exposed for 72 hours

to continuous-wave RF radiation at 830 MHz (SAR, 1.6–8.8 W/kg), in an incubator set at temperatures between 33.5 °C (at the highest SAR value) and 37.5 °C. The incidence of aneuploidy of chromosome 17 was determined by use of a probe for α -satellite DNA repeat-sequences present in its centromeric region. The data indicated a linear and SAR-dependent increase in aneuploidy in cells exposed to RF radiation at SAR 2.0–8.2 W/kg (6–9%) compared with control cells (4–5%). Control experiments without RF radiation were conducted at 34.5–41 °C, showing no change in aneuploidy at temperatures up to 38.5 °C. This indicates that the effect of RF radiation was produced via a non-thermal pathway ([Mashevich *et al.*, 2003](#)).

Peripheral blood lymphocytes from nine donors were stimulated with PHA for 1–6 hours, then exposed to continuous-wave RF radiation at 100 GHz (power density, 0.031 mW/cm²) for 1, 2 or 24 hours in an incubator in which CO₂ levels were not controlled. After exposure, the cells were incubated for a total culture period of 69–72 hours, with CO₂ levels at 5%. The cells were harvested and changes in chromosomes 1, 10, 11 and 17 were analysed by means of the FISH technique. For chromosomes 11 and 17, a 30% increase in aneuploidy was found after exposure for 2 or 24 hours, while chromosomes 1 and 10 were not affected. Asynchronous replication of centromeres 1, 11, and 17 was increased by 40% after 2 hours of exposure, while that of all four centromeres had increased by 50% after 24 hours of exposure. During the experiments, fibre-optic sensors were used to measure differences in temperature between exposed and sham-exposed samples; the difference never exceeded 0.3 °C ([Korenstein-Ilan *et al.*, 2008](#)).

[Mazor *et al.* \(2008\)](#) exposed PHA-stimulated lymphocytes from 10 individuals to continuous-wave RF radiation at 800 MHz (SAR, 2.9 or 4.1 W/kg) for 72 hours, with the incubator set at 33.5 °C to maintain the sample temperature at 36–37 °C, in particular at the high SAR value.

Aneuploidy was scored for chromosomes 1, 10, 11, and 17 by use of the FISH technique. An increased frequency of cells aneuploid for chromosomes 11 and 17 was observed at the lower SAR of 2.9 W/kg, and for chromosomes 1 and 10 at the higher SAR of 4.1 W/kg. Multisomy (chromosomal gain) was the primary contributor to the increase in aneuploidy. Control experiments – without exposure to RF radiation – were conducted in the temperature range 33.5–41 °C; there was no change in aneuploidy.

Spindle disturbance (experiments with human-hamster hybrid cells)

The well established human–hamster hybrid (A_L) cell line, containing a single copy of human chromosome 11, was exposed to pulsed-wave RF radiation at 835 MHz, with increasing electric field strengths from 5 to 90 V/m, for 30 minutes ([Schmid & Schrader, 2007](#)). The results indicated a field strength-dependent increase in the frequency of spindle disturbances during anaphase/telophase of cell division. [The Working Group noted the absence of negative and positive controls.] [Schrader et al. \(2008\)](#) reported similar increases in spindle disturbances in A_L cells exposed for 30 minutes or 2 hours to RF radiation at 835 MHz (90 V/m) compared with non-exposed controls. [Schrader et al. \(2011\)](#) exposed A_L cells to RF radiation at 900 MHz (amplitude-modulated and unmodulated), at electric field strengths of 45 or 90 V/m, and with a SAR of 11.5 W/kg, for 30 minutes. The experiments were conducted with separate electric (E field) and magnetic (H field) components of RF radiation, at 20–22 °C. A significant increase in the frequency of spindle disturbances was observed in cells exposed to the E component, while no effect was seen in cells exposed to the H component (compared with non-exposed control cells). [Hintzsche et al. \(2011\)](#) also reported an increase in spindle disturbance during the anaphase/telophase of cell division in the same A_L cell line exposed to continuous-wave RF radiation at

106 GHz (power densities, 0.043–4.3 mW/cm²) for 30 minutes.

(ii) Studies with two or more end-points

[Tice et al. \(2002\)](#) reported a significant and reproducible increase in micronucleus formation in human lymphocytes exposed for 24 hours to RF radiation at 837 or 1909.8 MHz, with an average SAR of 5.0 or 10.0 W/kg. There was no increase in the number of DNA strand breaks in leukocytes, as measured with the alkaline comet assay. [McNamee et al. \(2002a, 2003\)](#) reported no effects on DNA strand-break induction or micronucleus formation in cells exposed to continuous- or pulsed-wave RF radiation at 1900 MHz, with SARs of up to 10 W/kg, for 2 or 24 hours. [Zhang et al. \(2002\)](#) observed no induction of DNA strand breaks or formation of micronuclei in human lymphocytes exposed to pulsed-wave RF radiation at 2450 MHz compared with controls. [Zeni et al. \(2008\)](#) reported no increase in DNA strand breaks or micronucleus formation in human lymphocytes exposed to intermittent (6 minutes on, 2 hours off) RF radiation at 1900 MHz (SAR, 2.2 W/kg) for 24–68 hours. Likewise, [Schwarz et al. \(2008\)](#), reported no increase in DNA strand-break induction or micronucleus formation in PHA-stimulated or non-stimulated human lymphocytes exposed for 16 hours to intermittent (5 minutes on, 10 minutes off) RF radiation at 1950 MHz (SAR, 0.1 W/kg).

[Garaj-Vrhovac et al. \(1992\)](#) reported significantly increased frequencies of chromosomal aberrations and micronuclei in human peripheral blood lymphocytes exposed for up to 60 minutes to continuous-wave RF radiation at 7700 MHz, with power densities up to 30 mW/cm².

In a series of studies from one laboratory, no increase in the frequency of chromosomal aberrations or micronuclei was reported in human lymphocytes exposed to RF radiation at 2450 MHz for 90 minutes, to continuous-wave RF radiation at 835 or 847 MHz for 24 hours, or

to RF radiation at 2450 or 8200 MHz for 2 hours ([Vijayalaxmi et al., 1997b](#), [2001b](#), [c](#), [2006](#)).

[Maes et al. \(1993\)](#) found a time-dependent increase in the frequencies of chromosomal aberrations and micronuclei in peripheral blood lymphocytes exposed to pulsed-wave RF radiation at 2450 MHz (SAR, 75 W/kg) for 30 or 120 minutes. Both effects were statistically significant for the exposure of 120 minutes. No induction of SCE was found. In this study, the microwave output was adjusted by use of a thermistor thermometer to maintain the temperature of the cells at 36.1 °C. In subsequent experiments, [Maes et al. \(2000, 2001\)](#) examined human lymphocytes exposed to pulsed-wave RF radiation at 455.7 MHz (SAR, 6.5 W/kg) or 900 MHz (SAR, 0.4–10 W/kg) for 2 hours; no increase in chromosomal aberrations or SCE was observed.

[Stronati et al. \(2006\)](#) did not report significant changes in DNA strand-break induction, chromosomal aberrations, micronucleus formation or SCE in blood cells exposed to pulsed-wave RF radiation at 935 MHz (SAR, 1 or 2 W/kg). [Eberle et al. \(1996\)](#) measured chromosomal aberrations, micronucleus formation, SCE, and mutations at the *HPRT* locus in human lymphocytes exposed to RF radiation at 440, 900, or 1800 MHz (SAR, 1.5 W/kg). Exposure times varied (39, 50, 70 hours), depending on the experiment. No significant effects were observed for any of these end-points in RF-exposed cells compared with controls.

(b) *Humans: other primary and continuously growing cultured cells*

Some details on the exposure conditions to RF radiation and a short conclusion for each publication are presented in [Table 4.5](#).

(i) *Amniotic cells*

Human amniotic cells were exposed to RF radiation at 900 MHz (GSM; SAR, 0.25 W/kg) for 24 hours. Chromosomes were stained by use of the R-banding method and examined to determine

the incidence of structural and numerical aberrations. Exposure to RF radiation had no effect ([Bourthoumieu et al., 2010](#)). [The Working Group noted that R-banding is not recommended for analysis of chromosomal aberrations.] In a subsequent study by the same authors, amniotic cells were collected during amniocentesis from three separate donors. The cells were cultured for 15 days before being exposed to RF radiation at 900 MHz (GSM, pulsed-wave; pulse duration, 0.577 ms; pulse-repetition rate, 217 Hz; SAR, 0.25, 1, 2 or 4 W/kg) for 24 hours in a wire-patch cell at exposure temperatures of 36.3 ± 0.4 °C, 37.0 ± 0.2 °C, 37.5 ± 0.4 °C and 39.7 ± 0.8 °C, respectively, for the four SAR levels. The cells were processed for analysis by two-colour FISH with centromeric α -satellite repetitive probes for chromosomes 11 and 17 in interphase cells. No significant differences were observed between exposed and sham-exposed cells in the percentages of monosomic, trisomic cells or the total number of cells aneuploid for chromosomes 11 or 17 ([Bourthoumieu et al., 2011](#)).

(ii) *Glioblastoma and neuroblastoma cells*

No effects on DNA strand-break induction were observed in human U87MG glioblastoma cells exposed for up to 24 hours to continuous-wave or pulsed-wave RF radiation at 835, 847, or 2450 MHz (SAR, 0.6 W/kg at 835/847 MHz, and 0.7 or 1.9 W/kg at 2450 MHz) ([Malyapa et al. \(1997a, b\)](#)).

[Miyakoshi et al. \(2002\)](#) did not find an effect on DNA strand-break induction in human MO54 glial cells – derived from a patient with a brain tumour – exposed to RF radiation at 2450 MHz (average SAR, 50 or 100 W/kg) for 2 hours. Likewise, [Sakuma et al. \(2006\)](#) reported no effect on DNA strand-break induction in human A172 glioblastoma cells exposed to pulsed-wave RF radiation at 2142.5 MHz (SAR, up to 800 mW/kg) for 2 or 24 hours, and [Luukkonen et al. \(2009, 2010\)](#) found no effects on DNA strand-break induction in cultured human SH-SY5Y

Table 4.5 Genetic and related effects in human cells (other than lymphocytes) exposed to radiofrequency radiation *in vitro*

End-point	Cells	Frequency	SAR or power density	Duration	Results	Comments	Reference
Aneuploidy	HAC	900 MHz, PW; GSM	0.25, 1, 2, 4 W/kg	24 h	-	Chromosomes 11 and 17 were included in this study	Bourthoumieu <i>et al.</i> (2011)
Chromosomal aberration	HAC	900 MHz, PW; GSM	0.25 W/kg	24 h	-		Bourthoumieu <i>et al.</i> (2010)
Micronucleus formation	BUC	PW; mobile phone	NR	1 h/d for 2.3 yr	+		Yadav & Sharma (2008)
Micronucleus formation	BUC	PW; mobile phone	NR	3 h/wk for 5–10 yr	-		Hintzsche & Stopper (2010)
Micronucleus formation	HSF	1800 MHz, CW, PW(i); GSM	2 W/kg	1, 4, 24 h	-	Replication study. Previous results not confirmed.	Speit <i>et al.</i> (2007)
Micronucleus formation	SHF	1950 MHz, PW(c-i); UMTS	0.05–2 W/kg	4–48 h	+ after 12 h exposure	Controversial data	Schwarz <i>et al.</i> (2008)
Micronucleus formation	SHF	900 MHz, PW; GSM	1 W/kg	24 h	-		Sannino <i>et al.</i> (2009b)
DNA single- and double-strand breaks	GLB	2450 MHz, CW	0.7 W/kg	2–24 h	-		Malyapa <i>et al.</i> (1997a)
DNA single- and double-strand breaks	GLB	835, 847 MHz, CW, PW; FMCW, CDMA	0.6 W/kg	2–24 h	-		Malyapa <i>et al.</i> (1997b)
DNA single- and double-strand breaks	GLB	2450 MHz	13–100 W/kg	2 h	-		Miyakoshi <i>et al.</i> (2002)
DNA single- and double-strand breaks	GLB	2000 MHz, PW; CW, IMT	0.08, 0.25, 0.80 W/kg	2 h, 24 h	-		Sakuma <i>et al.</i> (2006)
DNA single- and double-strand breaks	HSF	1800 MHz, CW, PW(i); GSM	2 W/kg	1, 4, 24 h	-	Replication study. Previous results not confirmed.	Speit <i>et al.</i> (2007)
DNA single- and double-strand breaks	HTR	1817 MHz, PW; GSM	2 W/kg	1 h	-		Valbonesi <i>et al.</i> (2008)

Table 4.5 (continued)

End-point	Cells	Frequency	SAR or power density	Duration	Results	Comments	Reference
DNA single- and double-strand breaks	HTR	1800 MHz, CW, PW(i); GSM	2 W/kg	4–24 h	– with CW – with PW at 4 h + with PW at 16 h and 24 h	Differential response between CW and PW and exposure duration	Franzellitti et al. (2010)
DNA single- and double-strand breaks	LEP	1800 MHz, PW; GSM	1, 2, 3 W/kg	2 h	– at 1 and 2 W/kg + at 3 W/kg		Lixia et al. (2006)
DNA single- and double-strand breaks	LEP	1800 MHz, PW(i); GSM	1, 2, 3, 4 W/kg	2 h	– at 1 and 2 W/kg + at 3 and 4 W/kg		Yao et al. (2008)
DNA single- and double-strand breaks	LUF	2000 MHz, PW, CW; IMT	0.08 W/kg	2, 24 h	–		Sakuma et al. (2006)
DNA single- and double-strand breaks	LYB	813, 836 MHz, PW; iDEN, TDMA	2.4–26 mW/kg	2–21 h	±	Inconsistent results	Phillips et al. (1998)
DNA single- and double-strand breaks	LYB	813, 836, 835, 847 MHz, CW, PW; iDEN, TDMA, FDMA, CDMA	0.0024–0.026 W/kg, 3.2 W/kg	2–21 h	–		Hook et al. (2004a)
DNA single- and double-strand breaks	LYB	1800 MHz, PW; GSM	2 W/kg	6–24 h	–		Zhijian et al. (2010)
DNA single- and double-strand breaks	NUB	872 MHz, CW, PW; GSM	5 W/kg	1 h	–	Temperature-controlled conditions	Luukkonen et al. (2009)
DNA single- and double-strand breaks	NUB	872 MHz, CW, PW; GSM	5 W/kg	3 h	–	Temperature-controlled conditions	Luukkonen et al. (2010)
DNA single- and double-strand breaks	SHF	1800 MHz, PW (c, i)	2 W/kg	4–24 h	+	Controversial data	Diem et al. (2005)
DNA single- and double-strand breaks	SHF	1950 MHz, PW(c-i); UMTS	0.05–2 W/kg	4–48 h	+	Controversial data	Schwarz et al. (2008)

Table 4.5 (continued)

End-point	Cells	Frequency	SAR or power density	Duration	Results	Comments	Reference
DNA single- and double-strand breaks	SHF	900 MHz, PW; GSM	1 W/kg	24 h	–		Sannino <i>et al.</i> (2009b)
Foci	HFB, MST	905, 915, 1947 MHz, PW; GSM, UMTS	0.037, 0.039 W/kg	1–3 h	+ at 915MHz – at 905 MHz + at 1947 MHz	Decrease in 53BP1-foci, measured by immunostaining	Markovà <i>et al.</i> (2010)
Spindle disturbance	HHH	835 MHz, PW; GSM	5–90 V/m	30 min	+	Mitotic cell fraction was scored on slides stained with 2% acetic orcein.	Schmid & Schrader (2007)
Spindle disturbance	HHH	835 MHz, PW	62.5 mW/kg	10 min to 2 h	+	Mitotic cell fraction was scored on slides stained with 2% acetic orcein.	Schrader <i>et al.</i> (2008)
Spindle disturbance	HHH	1060 MHz, CW	0.043–4.3 mW/cm ²	30 min	+	Mitotic cell fraction was scored on slides stained with 2% acetic orcein.	Hintzsche <i>et al.</i> (2011)
Spindle disturbance	HHH	900 MHz, CW, PW	0.0115 W/kg	30 min	+	Mitotic cell fraction was scored on slides stained with 2% acetic orcein.	Schrader <i>et al.</i> (2011)
8-OHdG, oxidative damage in DNA	SPR	1800 MHz	0.4–27.5 W/kg	16 h	+	Temperature controlled at 21 °C; maximum increase 0.4 °C during exposure.	De Iuliis <i>et al.</i> (2009)

+, increase; ±, equivocal; –, no effect; 8-OHdG, 8-hydroxy-2'-deoxyguanosine; BUC, human buccal cells; (c, i), continuous and intermittent exposure; d, day; FDMA, frequency-division multiple access; FMCW, frequency-modulated continuous wave; GLB, glioblastoma cells; h, hour; HAC, human amniotic cells; HFB, human foreskin fibroblasts; HHH, hamster–human hybrid cells; HTR, trophoblast cells; iDEN, Integrated Digital Enhanced Network; IMT, International Mobile Telecommunication; LEP, lens epithelial cells; LUF, human fibroblasts from fetal lung; LYB, lymphoblastoid cells; min, minute; MST, mesenchymal stem cells; NUB, neuroblastoma cells; NR, not reported; SHF, skin human fibroblasts; SPR, sperm cells; TDAM, time-division multiple access; yr, year

neuroblastoma cells exposed to continuous- or pulsed-wave RF radiation at 872 MHz, with a SAR of 5 W/kg. In the studies mentioned above the alkaline comet assay was used to measure strand breakage in DNA.

(iii) *Lens epithelial cells*

Immortalized SRA01/04 human lens epithelial cells were exposed to pulsed-wave RF radiation at 1800 MHz (SAR, 1, 2 or 3 W/kg) for 2 hours to investigate induction of DNA breakage, which was measured by means of the alkaline comet assay. DNA-damage repair was evaluated by further incubation of the exposed cells for 30, 60, 120 or 240 minutes. There was a significant increase ($P < 0.05$) in DNA strand-breaks at a SAR of 3 W/kg immediately after exposure, which had decreased at 30 minutes, and had diminished to control levels at later time-points. At SARs of 1 and 2 W/kg, there were no significant differences between exposed cells and sham-exposed controls ([Lixia et al., 2006](#)).

In a similar study, DNA strand breaks were measured in SRA01/04 human lens epithelial cells exposed to intermittent (5 minutes on, 10 minutes off) pulsed-wave RF radiation at 1800 MHz (SAR, 1, 2, 3, or 4 W/kg) for 2 hours. There was no effect on DNA single-strand breaks – measured with the alkaline comet assay – at SARs of 1 or 2 W/kg, but a significant increase at SARs of 3 or 4 W/kg ($P < 0.001$). At these two higher SAR values, there was no difference in the induction of DNA double-strand breaks, measured with the γ H2AX-focus formation assay ([Yao et al., 2008](#)).

(iv) *Lung fibroblasts*

[Sakuma et al. \(2006\)](#) exposed human IMR-90 fetal lung fibroblasts to pulsed-wave RF radiation at 2000 MHz (SAR, 80 mW/kg) for 24 hours, and observed no effect on induction of DNA strand breaks.

(v) *Lymphoblastoid cells*

[Phillips et al. \(1998\)](#) studied DNA strand-break induction in human Molt-4 lymphoblastoid cells exposed for 2, 3 or 21 hours to RF radiation at 813 or 835 MHz as iDEN (Integrated Digital Enhanced Network) and TDMA (time-division multiple access) signals, with very low SARs of 2.4, 24, 2.6 and 26 mW/kg. There was a general decrease in the number of strand breaks at lower SARs at 2 and 21 hours (but not at 3 hours), and inconsistent results at higher SARs, depending on the type of RF signal, power intensity and duration of exposure. [Hook et al. \(2004a\)](#) examined DNA strand-break induction in Molt-4 cells exposed to the same and additional signals (813.56–847.74 MHz) at the same and higher SARs (2.4 mW/kg–3.4 W/kg) than in the study by [Phillips et al. \(1998\)](#). No effect on DNA strand-break induction was noted. [Zhijian et al. \(2010\)](#) did not find any effect on DNA strand-break induction when human HMy2.CIR lymphoblastoid B-cells were exposed to pulsed-wave RF radiation at 1800 MHz (SAR, 2 W/kg), for 6–24 hours.

(vi) *Skin fibroblasts*

[Diem et al. \(2005\)](#) exposed human ES-1 skin fibroblasts to continuous or intermittent (5 minutes on, 10 minutes off) RF radiation at 1800 MHz (SAR, 1.2 or 2 W/kg) for 4–24 hours. The cells were examined visually and subjectively to evaluate DNA single- and double-strand breaks by use of the alkaline and neutral comet assays. A “tail factor” was devised to express the results. The authors concluded that: there was a significant increase in tail factor after a 16-hour exposure, with no further increase after 24 hours; and that intermittent exposure produced a stronger effect than continuous exposure.

In a study from the same group, [Schwarz et al. \(2008\)](#) used ES-1 cells exposed for 4–48 hours to continuous and intermittent RF radiation at 1950 MHz (UMTS), with a range of SAR values (0.05–2 W/kg). The results from the analyses of

DNA strand breaks by means of the comet assay indicated a significant increase in tail factor ($P < 0.02$) at SAR 0.05 W/kg. In addition, there was a significant increase ($P < 0.02$, at SAR 0.05 W/kg) in the frequency of micronuclei, which turned out to be centromere-negative (suggesting a clastogenic effect). In a similar experiment in peripheral blood lymphocytes, there was no effect on the comet tail factor or micronucleus formation (see above). Several discussions about the mode of data acquisition in these two studies subsequently appeared in scientific journals ([Rüdiger et al., 2006](#); [Vijayalaxmi et al., 2006](#); [Tuffs, 2008](#); [Vogel, 2008](#); [Wolf, 2008](#); [Balzano, 2008](#); [Kuster, 2008](#); [Drexler & Schaller, 2009](#); [Rüdiger, 2009b, c](#); [Lerchl & Wilhelm, 2010](#); [Baan, 2009](#)).

[Speit et al. \(2007\)](#) performed independent experiments to replicate and confirm the results of the two studies mentioned above, by use of the same ES-1 skin fibroblasts, the same exposure system supplied by the same company, and the same laboratory protocols. The comet tail factor as well as computerized image-analysis were used to quantify the DNA strand breaks. The experiments were also performed in Chinese hamster V79 cells. The results showed no effect on DNA breakage either by the alkaline comet assay or by the micronucleus test, in either fibroblasts or V79 cells.

Skin fibroblasts established from healthy individuals or from subjects with Turner syndrome were exposed to 900 MHz pulsed-wave RF radiation (SAR, 1 W/kg). It was suggested that cells from patients with Turner syndrome were sensitive to the effects of weakly genotoxic agents ([Scarfi et al., 1997a, b](#)). No effects on DNA strand-break induction or micronucleus formation were observed in either cell line ([Sannino et al., 2009b](#)).

[Markovà et al. \(2010\)](#) observed no effect on 53BP1 foci in skin fibroblasts exposed to RF radiation at 905 MHz (SAR, 37 mW/kg). In contrast, a decrease was seen when the same cells were exposed at 915 or 1947 MHz at similar SAR

levels [the Working Group noted that this technique assesses repair foci of DNA double-strand breaks; it is different from the comet assay used for analysis of DNA strand breaks in the other studies with skin cells discussed above].

(vii) *Mesenchymal stem cells*

[Markovà et al. \(2010\)](#) observed a decrease in the number of 53BP1 foci in mesenchymal stem cells exposed to RF radiation at 915 or 1947 MHz (GSM; SAR 37 and 39 mW/kg, respectively) for 1, 2, or 3 hours; no effect was noted after exposure at 905 MHz (SAR, 37 mW/kg).

(viii) *Sperm cells*

[De Iuliis et al. \(2009\)](#) studied purified human spermatozoa exposed to RF radiation at 1800 MHz (SAR, 0.4–27.5 W/kg) for 16 hours at 21 °C. With increasing SAR values, motility and vitality of the sperm cells were significantly reduced, while mitochondrial production of reactive oxygen species was significantly increased ($P < 0.001$). There was also a significant increase ($P < 0.05$) in formation of 8-OHdG adducts (measured immunochemically) and DNA fragmentation (measured with the TUNEL – terminal deoxynucleotidyl transferase dUTP nick end labelling – assay) at SARs of 2.8 W/kg and higher. The temperature during these experiments was kept at 21 °C; the highest observed exposure-induced temperature increase was +0.4 °C, at a SAR of 27.5 W/kg.

(ix) *Trophoblast cells*

[Valbonesi et al. \(2008\)](#) observed no effects on DNA strand-break induction in human HTR-8/SVneo trophoblast cells exposed to pulse-modulated RF radiation at 1817 MHz (SAR, 2 W/kg) for 1 hour.

[Franzellitti et al. \(2010\)](#) observed no effects on DNA strand-break induction in HTR-8/SVneo trophoblast cells exposed to continuous-wave RF radiation at 1800 MHz (SAR, 2 W/kg) for 4, 16 or 24 hours. Exposure to this radiation as pulsed-wave amplitude-modulated signals (GSM-217 Hz

and GSM-Talk), caused a significant increase in DNA strand breakage after all three treatment periods when the results of the comet assay were expressed as “% DNA in tail.” The number of DNA strand breaks decreased rapidly during the 2 hours after exposure.

(c) *Humans: interaction of RF radiation with known genotoxic agents*

Some details on the exposure conditions to RF radiation and a short conclusion for each publication are presented in [Table 4.6](#). Unless otherwise mentioned, the results discussed below refer to those observed in human peripheral blood lymphocytes exposed to RF radiation before, during or after exposure to a genotoxic agent.

(i) *Chemotherapeutic drugs*

[Gadhia et al. \(2003\)](#) reported a synergistic increase in chromosomal aberrations (rings, dicentrics) and SCE in lymphocytes collected from mobile-phone users and treated with mitomycin C (MMC) *in vitro*, compared with cells from controls (non-phone users) treated with MMC. This effect was stronger in mobile-phone users who smoked and consumed alcohol.

[Maes et al. \(2006\)](#) found no effect of treatment with MMC on induction of DNA strand breaks, chromosomal aberrations or SCE in lymphocytes obtained from workers at a mobile-phone company. In a series of experiments *in vitro*, the same authors reported a highly reproducible synergistic effect ([Maes et al., 1996](#)), a weak synergistic effect ([Maes et al., 1997](#)), an inconsistent synergistic effect ([Maes et al., 2000](#)), or no synergistic effect ([Maes et al., 2001](#)) of exposure to RF radiation on MMC-induced SCE. [The Working Group noted that the authors made several suggestions regarding possible mechanistic explanations for their findings, which were not pursued in detail. The authors also mentioned the possibility of a thermal effect, and indicated

the incomplete characterization of the exposure conditions in their studies.]

[Zhang et al. \(2002\)](#) investigated a possible synergistic effect in human lymphocytes exposed to RF radiation at 2450 MHz (5 mW/cm²; 2 hours) followed by treatment with MMC (0.0125–0.1 µg/ml; 24 hours). While RF radiation had no effect by itself, it significantly increased the effect of the higher doses of MMC on DNA strand-break induction and micronucleus formation. Since the temperature increase during the 2-hour exposure was less than 0.5 °C, the synergy was not likely to be due to thermal effects.

[Baohong et al. \(2005\)](#) exposed human lymphocytes to pulsed-wave RF radiation at 1800 MHz (SAR, 3 W/kg) for 2 hours, before, together with, or after incubation for 3 hours with four different chemicals. After these treatments, the cells were washed and processed for measurement of DNA strand-break induction at once or after further incubation for 21 hours. Exposure to RF radiation alone had no effect. All combinations of MMC or 4-nitroquinoline-1-oxide (4NQO) with RF radiation showed a significant increase in DNA breakage, compared with the results after incubation with the chemical alone. No such effect was observed when exposure to RF radiation was combined with treatment with bleomycin or methylmethane sulfonate (MMS), suggesting that interaction between RF radiation and different chemical mutagens could vary.

[Hansteen et al. \(2009a\)](#) found no effect on MMC-induced chromosomal aberrations after exposure of human lymphocytes to pulsed-wave RF radiation at 16.5 GHz (power density, 10 W/m²) or 18 GHz continuous-wave RF radiation (power density 1 W/m²) for 53 hours, with MMC added after 30 hours. Similar results were reported by the same authors for exposures to continuous-wave or pulsed-wave RF radiation at 2.3 GHz (power density, 10 W/m²) in combination with MMC ([Hansteen et al., 2009b](#)).

[Sannino et al. \(2009a\)](#) reported that pre-exposure of human lymphocytes to pulsed-wave RF

Table 4.6 Interaction between radiofrequency radiation and known genotoxic agents in human cells *in vitro*

End-point	Cells	Genotoxic agent	Frequency (MHz)	SAR or power density	Duration	Results	Comments	Reference
Chromosomal aberration	PBL	MMC or X-rays	900 MHz, PW; GSM	0.4–10 W/kg	RF radiation for 2 h, followed by X-rays for 1 min (1 Gy) or MMC for 72 h	–	No effect of RF radiation; no synergistic effects of RF radiation and MMC or X-rays	Maes et al. (2001)
Chromosomal aberration	PBL from phone users	MMC	890–960 MHz, PW; GSM	NR	Phone use for 1–3 h/d for 2 yr, MMC for 48 h	+	Increased gaps/dicentrics after RF radiation; synergistic effect of RF radiation with MMC	Gadhia et al. (2003)
Chromosomal aberration	PBL	Gamma-rays	2500 MHz 10 500 MHz, PW	627 W/kg 0.25 W/kg	40 s 5 min	–	MW oven used as 2.5 GHz source. No effect of RF radiation; no synergistic effect with gamma-rays	Figueiredo et al. (2004)
Chromosomal aberration	PBL	MMC	400–900 MHz, PW	NR	2.3 yr (> 1h/d) MMC for 72 h	–	Lymphocytes from exposed workers. No synergistic effect with MMC	Maes et al. (2006)
Chromosomal aberration	PBL	X-rays	935 MHz, PW; GSM	1 or 2 W/kg	1 min (1 Gy) X-rays, 24 h RF radiation	–	No effect of RF radiation; no synergistic effect with X-rays	Stronati et al. (2006)
Chromosomal aberration	PBL	X-rays	1950 MHz, PW, UMTS	0.5, 2 W/kg	X-rays 5 min, RF radiation for 24 h	+ at 2 W/kg – at 0.5 W/kg	No effect of RF radiation; synergistic effect of RF radiation with X-rays (4 Gy) at the higher SAR	Manti et al. (2008)
Chromosomal aberration	PBL	MMC	1800, 1650 MHz, CW, PW	0.1, 1 mW/cm ²	53 h; MMC added at 30 h	–	No effect of RF radiation; no synergistic effect with MMC	Hansteen et al. (2009a)
Chromosomal aberration	PBL	MMC	2300 MHz, CW, PW	1 mW/cm ²	53 h; MMC added at 30 h	–	No effect of RF radiation; no synergistic effect with MMC	Hansteen et al. (2009b)
Micronucleus formation	PBL	MMC	2450 MHz, PW	5 mW/cm ²	2 h, then MMC for 24 h	+	No effect of RF radiation; synergistic effect with MMC	Zhang et al. (2002)
Micronucleus formation	PBL	X-rays	935 MHz, PW; GSM	1 or 2 W/kg	1 min (1 Gy) X-rays, 24 h RF	–	No effect of RF radiation; no synergistic effect with X-rays	Stronati et al. (2006)
Micronucleus formation	PBL	MMC	900 MHz, PW; GSM	1.25 W/kg	20 h; MMC for 24 h	+	Reduction of MMC-induced MN frequency (adaptive response?) in lymphocytes from 4 out of 5 donors	Sannino et al. (2009a)

Table 4.6 (continued)

End-point	Cells	Genotoxic agent	Frequency (MHz)	SAR or power density	Duration	Results	Comments	Reference
DNA single- and double-strand breaks	PBL	MMC	2450 MHz, PW	5 mW/cm ²	2 h, then MMC for 24 h	+	No effect of RF radiation; synergistic effect with MMC	Zhang et al. (2002)
DNA single- and double-strand breaks	PBL	MMC, 4NQO	1800 MHz, PW; GSM	3 W/kg	2 h RF irradiation, 3 h with the chemical	+	No effect of RF radiation. Exposure to chemicals before, during or after RF irradiation showed a synergistic effect with MMC and 4NQO	Baohong et al. (2005)
DNA single- and double-strand breaks	PBL	BLM, MMS	1800 MHz, PW, GSM	3 W/kg	2 h RF radiation 3 h with the chemical	-	No effect of RF radiation. Exposure to chemicals before, during or after RF irradiation showed no synergistic effect with BLM and MMS	Baohong et al. (2005)
DNA single- and double-strand breaks	PBL	MMC	400–900 MHz, PW	NR	2.3 yr (> 1 h/d) MMC for 72 h	-	Lymphocytes from exposed workers. No synergistic effect with MMC	Maes et al. (2006)
DNA single- and double-strand breaks	PBL	X-rays	935 MHz, PW; GSM	1 or 2 W/kg	1 min (1 Gy) X-rays, 24 h RF	-	No effect of RF radiation; no synergistic effect with X-rays	Stronati et al. (2006)
DNA single- and double-strand breaks	PBL	UV	1800 MHz, PW; GSM	3 W/kg	1.5 or 4 h; just after UVC at 0.25–2.0 J/m ²	+ at 4 h + at 1.5 h	Effect with UV depended on exposure duration: decrease at 1.5 h, increase at 4 h	Baohong et al. (2007)
DNA single- and double-strand breaks	PBL	APC	835 MHz, PW; CDMA	1.2 W/kg	1 h RF irradiation and APC at 0.2 or 2 µg/ml	+	No effect of RF radiation; synergistic RF effect on aphidicolin-induced repairable DNA damage.	Tiwari et al. (2008)
DNA single- and double-strand breaks	NUB	Menadione	872 MHz, CW, PW; GSM	5 W/kg	1 h RF and 50 µM menadione	+ with CW - with PW	Differential effect of CW and PW with menadione	Luukkonen et al. (2009)
DNA single- and double-strand breaks	HSF	MX	900 MHz, PW; GSM	1 W/kg	24 h RF, 1 h MX at 25 µM	-	No synergistic effect on MX-induced SB	Sannino et al. (2009b)
DNA single- and double-strand breaks	PBL	X-rays	1800 MHz, PW(i); GSM	2 W/kg	24 h (on/off for 5/10 min) then 0.25–2 Gy of X-rays	-	No effect of RF radiation; no synergistic effect with X-rays on SB induction or repair	Zhijian et al. (2009)

Table 4.6 (continued)

End-point	Cells	Genotoxic agent	Frequency (MHz)	SAR or power density	Duration	Results	Comments	Reference
DNA single- and double-strand breaks	NUB	FeCl ₂ + DEM	872 MHz, CW, PW; GSM	5 W/kg	1 h or 3 h RF; 1 h FeCl ₂ ± DEM	–	No effect of RF radiation; no synergistic effect with free radical-inducing chemicals	Luukkonen et al. (2010)
DNA single- and double-strand breaks	LYB	DOX	1800 MHz, PW; GSM	2 W/kg	6–24 h RF; 2 h DOX	–	No effect of RF radiation; no synergistic effect with doxorubicin on induction of single- or double-strand breaks; effect on repair (?)	Zhijian et al. (2010)
Sister-chromatid exchange	PBL	MMC	954 MHz, PW; GSM	1.5 W/kg	2 h RF radiation 72 h MMC	+	No effect of RF radiation; highly reproducible synergistic effect with MMC	Maes et al. (1996)
Sister-chromatid exchange	PBL	MMC	935.2 MHz, PW; GSM	0.3–0.4 W/kg	2 h RF radiation 72 h MMC	+	No effect of RF radiation: weak synergistic effect with MMC	Maes et al. (1997)
Sister-chromatid exchange	PBL	MMC	455.7 MHz, PW; car phone	6.5 W/kg	2 h (72 h MMC)	±	No effect of RF radiation; inconsistent synergistic effect with MMC	Maes et al. (2000)
Sister-chromatid exchange	PBL	MMC, X-rays	900 MHz, PW; GSM	0.4–10 W/kg	2 h (72 h MMC)	–	No effect of RF radiation; no synergistic effect with MMC or with X-rays	Maes et al. (2001)
Sister-chromatid exchange	PBL from phone users	MMC	890–960 MHz, PW; GSM	NR	1–3 h/d for 2 yr 48 h MMC	+	Increased SCE after RF radiation; synergistic effect with MMC	Gadhia et al. (2003)
Sister-chromatid exchange	PBL	MMC	400–900 MHz, PW	NR	72 h	–	No effect of RF radiation; no synergistic effect with with MMC	Maes et al. (2006)
Sister-chromatid exchange	PBL	X-rays	935 MHz, PW; GSM	1, 2 W/kg	24 h	–	No effect of RF radiation; no synergistic effect with X-rays	Stronati et al. (2006)

+, increase; ±, equivocal; –, no effect; 4NQO, 4-nitroquinoline-1-oxide; APC, aphidicolin; BLM, bleomycin; CW, continuous wave; d, day; DEM, diethyl maleate; FeCl₂, ferrous chloride; h, hour; HSF, human skin fibroblasts; (i), intermittent exposure; LYB, lymphoblastoid cells; min, minute; MMC, mitomycin C; MMS, methylmethane sulfonate; MX, 3-chloro-4-(dichloromethyl)-5-hydroxy-2(5H)-furanone; NUB, neuroblastoma cells; NR, not reported; PBL, peripheral blood lymphocytes; PW, pulsed wave

radiation at 900 MHz (peak SAR, 10 W/kg) for 20 hours reduced the incidence of MMC-induced micronucleus formation, suggesting that non-ionizing radiation is capable of inducing an “adaptive response” similar to that observed in several studies of ionizing radiation.

[Zhijian et al. \(2010\)](#) treated cultured human lymphoblastoid cells with doxorubicin (DOX) for 2 hours before, during and after exposure to pulsed-wave RF radiation at 1800 MHz (SAR, 2 W/kg). No significant effects on DOX-induced DNA strand-break formation were found.

(ii) Genotoxic chemicals

[Tiwari et al. \(2008\)](#) exposed human peripheral blood lymphocytes to RF radiation at 835 MHz (SAR, 1.17 W/kg) for 1 hour, with and without treatment with aphidicolin (APC; 0.2 or 2 µg/ml), an inhibitor of DNA repair. There was no effect on DNA strand-break induction of RF radiation by itself, or of the low dose of APC alone. There was a significant increase in DNA breakage after combined exposure of the cells to RF radiation with the low ($P = 0.025$) and the high dose ($P = 0.002$) of APC. [Sannino et al. \(2009b\)](#) found no effect on the number of DNA strand breaks induced by 3-chloro-4-(dichloromethyl)-5-hydroxy-2(5H)-furanone (MX) in skin fibroblasts from healthy individuals or from subjects with Turner syndrome exposed to pulsed-wave RF radiation at 900 MHz (SAR, 1 W/kg) for 24 hours, followed by treatment with MX for 1 hour.

[Luukkonen et al. \(2009\)](#) found a significant increase ($P < 0.01$) in the number of menadione-induced DNA strand breaks in cultured human SH-SY5Y neuroblastoma cells exposed to continuous-wave RF radiation at 872 MHz (SAR, 5 W/kg) and menadione (25 µM) for 1 hour, but not in cells exposed to pulsed-wave RF radiation (GSM) and menadione. In a subsequent study with the same cell type, the same authors did not observe an increase in the number of DNA strand breaks after exposure to continuous- or pulsed-wave RF radiation at the same frequency

and SAR (872 MHz; 5 W/kg), with or without ferrous chloride and diethyl maleate (the latter compound was added to enhance the free-radical production induced by the former) ([Luukkonen et al., 2010](#)).

(iii) Ionizing radiation

[Figueiredo et al. \(2004\)](#) reported no effects of RF radiation on the induction of chromosomal aberration by gamma radiation in human lymphocytes exposed to pulsed-wave RF radiation at 2.5 or 10.5 GHz (SAR, 627 and 0.25 W/kg, respectively) for 40 seconds or 5 minutes, respectively, followed 2 hours later by exposure to 1.5 Gy gamma radiation from a cobalt-60 source. No effect was observed after exposure to RF radiation alone. [Stronati et al. \(2006\)](#) found no effect of RF radiation on X-ray-induced DNA strand breaks, chromosomal aberrations, micronucleus formation or SCE in human peripheral blood lymphocytes exposed to pulsed-wave RF radiation at 935 MHz (SAR 1 or 2 W/kg) for 24 hours, combined with 1.0 Gy of 250 kVp X-rays, given for 1 minute immediately before or after exposure to RF radiation. In the FISH assay used by [Manti et al. \(2008\)](#), there was no effect of RF radiation on X-ray-induced chromosomal aberrations in human lymphocytes exposed to 4 Gy of X-rays immediately before exposure to pulsed-wave RF radiation at 1950 MHz (SAR, 0.5 W/kg), while a small but statistically significant increase ($P = 0.036$) was observed at a SAR of 2 W/kg. [Zhijian et al. \(2009\)](#) did not find an effect of RF radiation on DNA strand breaks induced by X-rays, or their repair, in lymphocytes exposed to intermittent (5 minutes on, 10 minutes off) pulsed-wave RF radiation at 1800 MHz (SAR, 2 W/kg) for 24 hours, followed by exposure to X-rays (0.25–2.0 Gy).

(iv) Ultraviolet radiation

[Baohong et al. \(2007\)](#) exposed peripheral blood lymphocytes to 254 nm ultraviolet radiation (UVC) at 0.25–2.0 J/m², followed by RF

radiation at 1800 MHz (SAR, 3 W/kg), for 1.5 or 4 hours. The number of UV-induced DNA strand breaks decreased after exposure to RF radiation for 1.5 hours, and increased after exposure for 4 hours.

(d) *Mammalian cells (non-human)*

See [Table 4.7](#)

(i) *800–1800 MHz*

Mouse C3H 10T½ fibroblast cells (both exponentially growing and in plateau phase) were exposed to RF radiation at 835.62 MHz as a frequency-modulated continuous-wave (FMCW) signal, or to RF radiation as a code-division multiple access (CDMA) signal at 847.74 MHz (SAR, 0.6 W/kg), for up to 24 hours. The alkaline comet assay was used to measure induction of DNA strand breaks. No significant differences were observed between the results obtained with FMCW or CDMA radiation and the sham-exposed negative controls ([Malyapa et al., 1997b](#)). The same authors did not find any effects in a similar experiment with continuous-wave RF radiation at 2450 MHz (SAR, 0.7 or 1.9 W/kg) ([Malyapa et al., 1997a](#)).

C3H 10T½ fibroblast cultures (exponentially growing or in the plateau phase) were exposed to RF radiation at 847.74 MHz as a CDMA signal, or to RF radiation at 835.62 MHz as a FDMA signal (SAR, 3.2–5.1 W/kg) for 2, 4, or 24 hours. The alkaline comet assay was used to measure induction of DNA strand breaks. No statistically significant change was found in tail moment or tail length for cells that had been exposed to RF radiation (CDMA or FDMA), compared with sham-exposed controls. Furthermore, in cells exposed for 2 hours to RF radiation, a post-incubation of 4 hours did not result in significant changes in tail moment or tail length ([Li et al., 2001](#)).

Exponentially growing or plateau-phase C3H 10T½ cells – derived from mouse-embryo fibroblasts – were exposed to RF radiation at

835.62 MHz, as CDMA (SAR, 3.2 or 4.8 W/kg) signal, or at 847.74 MHz as frequency-division multiple access (FDMA) signal (SAR, 3.2 or 5.1 W/kg), for 3, 8, 16 or 24 hours. No significant exposure-related differences in micronucleus formation were found for either plateau-phase cells or exponentially growing cells ([Bisht et al., 2002](#)).

[Diem et al. \(2005\)](#) reported the results of an alkaline comet assay with SV40-transformed rat granulosa cells exposed to continuous or intermittent (5 minutes on, 10 minutes off) RF radiation at 1800 MHz (SAR, 1.2 or 2 W/kg) for 4–24 hours. Both continuous and intermittent exposures induced DNA single- and double-strand breaks, with the greatest effect found with intermittent exposure. [Speit et al. \(2007\)](#) independently repeated some of the experiments with V79 Chinese hamster cells, using the same equipment and exposure conditions (1800 MHz; 2 W/kg SAR; continuous wave with intermittent exposure). No effects of exposure to RF radiation were found in assays for DNA strand-break induction and micronucleus formation.

Chinese hamster lung cells exposed to intermittent (5 minutes on, 10 minutes off) RF radiation at 1800 MHz (SAR, 3 W/kg) for 24 hours contained an increased number of γ -H2AX foci – a measure of DNA double-strand breaks – compared with sham-exposed cells. There was no effect after a 1-hour exposure to RF radiation ([Zhang et al., 2006](#)).

Because auditory cells could be exposed to RF radiation at frequencies at which mobile phones operate, [Huang et al. \(2008\)](#) used HEI-OC1 immortalized mouse auditory hair cells to characterize their response to exposure to RF radiation at 1763 MHz (SAR, 20 W/kg), in a CDMA exposure chamber for 24 or 48 hours. No changes were found in the phase-distribution of the cell cycle, DNA strand-break induction, stress response, or gene-expression profiles in the exposed cells, compared with sham-exposed controls.

Table 4.7 Genetic and related effects of exposure to radiofrequency radiation in experimental systems *in vitro*

Test system, end-point	Exposure conditions	Genotoxic agent	Results and comments	Reference
pBluescript SK(+) plasmid, DNA strand breaks (DNA degradation <i>in vitro</i>)	835 MHz, CW; SAR, 4 W/kg; 48 h	-	Exposure to RF radiation did not change the rate of degradation of plasmid pBluescript SK(+) exposed to H ₂ O ₂ (Fenton-type reaction) as an indicator.	Chang et al. (2005)
<i>Escherichia coli</i> WP2 <i>uvrA</i> , reverse mutation	835 MHz, CW; SAR, 4 W/kg; 48 h	4-NQO, for 48 h during exposure to RF radiation	RF radiation increased 4-NQO-induced mutation rate in <i>Escherichia coli</i> WP2.	Chang et al. (2005)
<i>Escherichia coli</i> WP2 <i>uvrA</i> , reverse mutation	2450 MHz; SAR, 5–200 W/kg; 30 min	-	No effect on mutagenicity	Koyama et al. (2007)
<i>Salmonella typhimurium</i> TA98, TA100, TA102 and TA1535, reverse mutation	835 MHz, CW; SAR, 4 W/kg; 48 h	4-NQO, cumene hydroperoxide (CHP) sodium azide (SA) for 48 h during exposure to RF radiation	RF radiation increased CHP-induced mutation rate in TA102, had no effect on SA-induced revertants in TA100, and reduced SA-induced mutation rate in TA1535	Chang et al. (2005)
<i>Salmonella typhimurium</i> TA98, TA100, TA1535 and TA1537; reverse mutation	2450 MHz; SAR, 5–200 W/kg; 30 min	-	No effect on mutagenicity	Koyama et al. (2007)
<i>Saccharomyces cerevisiae</i> , gene-specific forward mutation at <i>CAN1</i>	900 MHz, GSM pulsed-wave; SAR, 0.13; 1.3 W/kg	MMS	No significant effect on mutation rates at <i>CAN1</i> ± MMS	Gos et al. (2000)
<i>Saccharomyces cerevisiae</i> , induction of respiration-deficient (<i>petite</i>) clones (loss of mitochondrial function)	900 MHz, GSM pulsed-wave; SAR, 0.13; 1.3 W/kg	MMS	No significant effect on the frequency of <i>petite</i> colony formation ± MMS	Gos et al. (2000)
<i>Saccharomyces cerevisiae</i> , intrachromosomal deletion-formation assay	900 MHz, GSM pulsed-wave; SAR, 0.13; 1.3 W/kg	MMS	No significant effect on formation of intrachromosomal deletions ± MMS	Gos et al. (2000)
<i>Saccharomyces cerevisiae</i> , intra-genic recombination assay in the <i>ADE2</i> gene	900 MHz, GSM pulsed-wave; SAR, 0.13; 1.3 W/kg	MMS	No significant effect on rates of intragenic recombination ± MMS	Gos et al. (2000)
<i>Xenopus laevis</i> ; DNA SSB measured in erythrocytes sampled immediately after exposure	8800 MHz pulsed-wave; peak power, 65 kW; SAR, 1.6 W/kg; 40 min	-	No indication of non-thermal effects. Observed DNA damage probably due to temperature rise	Chemeris et al. (2004)
C3H10T½ mouse; DNA SSB measured in fibroblasts, sampled immediately and up to 4 h after exposure	2450 MHz CW; SAR, 0.7 and 1.9 W/kg; 2, 4 and 24 h	-	No effect	Malyapa et al. (1997a)

Table 4.7 (continued)

Test system, end-point	Exposure conditions	Genotoxic agent	Results and comments	Reference
C3H10T½ mouse; DNA SSB measured in fibroblasts, sampled immediately after exposure	835.62 MHz FMCW and 847.7 MHz, CDMA CW; SAR, 0.6 W/kg; 2, 4, 24 h	-	No effect	Malyapa et al. (1997b)
C3H10T½ mouse; DNA SSB measured in fibroblasts, sampled immediately and 4 h after exposure	835.6 MHz FDMA and 847.7 MHz FDMA; SAR, 3.2 and 5.1 W/kg; 2, 4 and 24 h exposure	-	No effect	Li et al. (2001)
C3H10T½ mouse; DNA SB, DNA–DNA and DNA–protein cross-links measured in fibroblasts	2450 MHz CW; SAR, 1.9 W/kg; 2 h exposure followed by 4 Gy gamma-rays	Gamma radiation	No effect of RF radiation on SB. No reduction by RF radiation of DNA migration induced by gamma-rays. No induction of DNA–protein crosslinks or changes in amount of DNA-associated protein by RF radiation	Lagroye et al. (2004b)
HEI-OC1 (immortalized mouse auditory hair) cells; DNA damage, stress response and gene expression	1763 MHz; SAR, 20 W/kg; CDMA; continuous exposure for 24 or 48 h	-	No effect on cellular responses, including cell-cycle distribution, DNA damage, stress response or gene expression	Huang et al. (2008)
L5178Y <i>Tk</i> ⁺ mouse lymphoma cells (DNA damage) and Chinese hamster lung fibroblasts (chromosomal aberrations, CA)	835 MHz; SAR, 4 W/kg; exposure for 48 h, alone or combined with chemicals	CPA, 4-NQO	No effect on DNA damage or CA. No effect on EMS-induced CA. Significant increase in CPA- and 4NQO-induced DNA damage.	Kim et al. (2008a)
Chinese hamster V79 cells; DNA damage (SSB, DSB)	1800 MHz; CW or pulsed-wave; continuous or intermittent (5 min on, 10 min off); SAR, 2 W/kg; exposure 1–24 h	-	No induction of DNA damage found in independent repeat experiments.	Speit et al. (2007)
Rat granulosa cells; DNA damage (SSB, DSB), sampled immediately after exposure	1800 MHz; CW or pulsed-wave; continuous and intermittent (5 min on, 10 min off); SAR, 2 W/kg; exposure 1–24 h	-	Induction of DNA SSB and DSB after 16 h intermittent exposure, at different mobile-phone modulations. Objections were raised to the analysis of the data	Diem et al. (2005)
Chinese hamster V79 cells; DNA synthesis, incorporation of [³ H] thymidine	7700 MHz; 300 mW/cm ² ; 15, 30, 60 min	-	Cells are blocked in entering S-phase	Garaj-Vrhovac et al. (1990b)

Table 4.7 (continued)

Test system, end-point	Exposure conditions	Genotoxic agent	Results and comments	Reference
Chinese hamster lung cells; DNA damage, gamma-H2AX focus formation	1800 MHz; intermittent (5 min on, 10 min off); SAR, 3.0 W/kg; for 1 or 24 h	-	RF radiation (24 h exposure, not 1 h) caused gamma-H2AX focus formation. A cell was classified positive when it contained more than five foci.	Zhang et al. (2006)
L5178Y <i>Tk</i> ^{+/-} mouse lymphoma cells; gene mutation	2450 MHz, pulsed-wave; power density, 488 W/m ² ; SAR, 30 or 40 W/kg; 4 h, together with MMC (at lower SAR) of proflavin (at higher SAR).	-	No effect of RF radiation alone. No influence by RF radiation on cell-growth inhibition or on MMC- or proflavin-induced mutagenesis	Meltz et al. (1989, 1990)
Chinese hamster ovary CHO K1 cells; gene mutation <i>Hprt</i> locus	2450 MHz, SAR, 5–200 W/kg; 2 h	Bleomycin, for 1 h before irradiation	RF radiation (200 W/kg) increased <i>Hprt</i> mutation frequency by itself, and increased bleomycin-induced <i>Hprt</i> mutations (100 and 200 W/kg). Effects may be due to hyperthermia	Koyama et al. (2007)
Chinese hamster ovary cells; SCE	2450 MHz, pulsed-wave; 490 W/m ² ; SAR, 33.8 W/kg; 2 h	Simultaneous exposure to adriamycin	No effect of RF radiation alone. No effect on adriamycin-induced SCE	Ciaravino et al. (1991)
C3H10T $\frac{1}{2}$ mouse fibroblasts; micronucleus formation	835.6 MHz CW, FDMA and 847.7 MHz CW, CDMA; SAR, 3.2 and 5.1 W/kg	-	No increase in frequency of micronucleus formation	Bisht et al. (2002)
Chinese hamster V79 cells; micronucleus formation	7700 MHz; 30 mW/cm ² ; 15, 30, 60 min	-	Increased micronucleus formation	Garaj-Vrhovac et al. (1991)
Chinese hamster ovary CHO-K1 cells; micronucleus formation	2450 MHz; SAR, 13, 39, 50, 78, 100 W/kg; 18 h	Bleomycin	Increased micronucleus frequency after RF radiation, and potentiation by RF radiation of bleomycin-induced micronucleus formation, both at SARs \geq 78 W/kg	Koyama et al. (2003)
Chinese hamster ovary CHO-K1 cells; micronucleus formation	2450 MHz; SAR, 5, 10, 20, 50, 100, 200 W/kg; 2 h	Bleomycin	Increased micronucleus formation at SARs of 100 and 200 W/kg. No combined effect of RF and bleomycin	Koyama et al. (2004)
Chinese hamster V79 cells; micronucleus formation	1800 MHz; CW or pulse-wave; continuous and intermittent (5 min on, 10 min off), 1–24 h; SAR, 2 W/kg	-	No effect found. This study was aimed at replicating earlier findings.	Speit et al. (2007)
Bovine lymphocytes; micronucleus formation	9000 MHz, 70 W/kg CW; 10 min	MMC	Increased micronucleus frequency after RF radiation; significant increase by RF radiation of MMC-induced micronuclei.	Scarfi et al. (1996)

Table 4.7 (continued)

Test system, end-point	Exposure conditions	Genotoxic agent	Results and comments	Reference
Mouse m5S cells; chromosomal aberrations	2450 MHz CW or PW; SAR, 5, 10, 20, 50, 100 W/ kg; 2 h	-	No effect	Komatsubara <i>et al.</i> (2005)
Chinese hamster V79 cells; chromosomal aberrations	7700 MHz, 300 mW/cm ² ; 15, 30, 60 min	-	Induction of chromosomal aberrations	Garaj-Vrhovac <i>et al.</i> (1990b)
Chinese hamster ovary cells; chromosomal aberrations	2450 MHz pulsed-wave; 490 mW/cm ² , SAR, 33.8 W/kg, 2 h	Simultaneous exposure to adriamycin or MMC	No effect of RF radiation alone No effect by RF radiation on aberrations induced by adriamycin or MMC	Kerbacher <i>et al.</i> (1990)
Chinese hamster V79 cells; chromosomal aberrations (structural)	7700 MHz, 30 mW/cm ² , 15, 30, 60 min	-	Increased frequency of chromosomal aberrations, including dicentric and ring chromosomes	Garaj-Vrhovac <i>et al.</i> (1991)
Chinese hamster ovary cells; cell-cycle progression	2450 MHz pulsed-wave; 490 mW/cm ² , SAR, 33.8 W/kg, 2 h	Simultaneous exposure to adriamycin	No effect of RF radiation alone No influence on cell-cycle progression caused by adriamycin	Ciaravino <i>et al.</i> (1991)
Chinese hamster V79 cells; cell growth (cell count, microtubule structure)	935 MHz; SAR: 0.12 W/kg; 1, 2, 3 h	-	Alteration of microtubule structure after a 3-h exposure; significantly decreased growth was noted in cells exposed for 3 h, at 3 d after exposure	Pavicic & Trosic, (2008)
Chinese hamster V79 cells; cell-proliferation kinetics, analysis of microtubule structure, mitotic index	935 MHz CW; SAR, 0.12 W/kg; 1, 2, 3 h	-	Alteration of microtubule structure; no effect on mitotic index. Cell proliferation was reduced at 72 h after exposure in cells exposed for 3 h. Slower cell-division kinetics	Trosić & Pavčić (2009)
Chinese hamster V79 cells; survival	7700 MHz; 0.5, 10, 30 mW/cm ² ; 10, 20, 30, 60 min	-	After 8 days of post-incubation: reduced cell survival related to power density and exposure time	Garaj-Vrhovac <i>et al.</i> (1991)

4-NQO, 4-nitroquinoline 1-oxide; CA, chromosomal aberrations; CDMA, code-division multiple access; CHP, cumene hydroperoxide; CPA, cyclophosphamide; CW, continuous wave; DSB, DNA double-strand breaks; FDMA, frequency-division multiple access; h, hour; *Hprt*, hypoxanthine-guanine phosphoribosyl transferase gene; min, minute; MMC, mitomycin C; MMS, methylmethane sulfonate; MN, micronuclei; SA, sodium azide; SCE, sister-chromatid exchange; SSB, DNA single-strand breaks

The alkaline comet assay and a test for chromosome aberrations *in vitro* were used to investigate the effects of 835 MHz RF radiation (4 W/kg), alone and in combination with the clastogens cyclophosphamide (CP), 4NQO and ethylmethane sulfonate (EMS), in L5178Y *Tk*⁺ mouse-lymphoma cells (to assess DNA breakage) and in Chinese hamster lung fibroblasts (to measure chromosome aberrations). In the latter cells, no effect was observed from RF radiation, alone or in combination with CP or EMS, but in the mouse-lymphoma cells a potentiating effect was noted on DNA strand-break induction after exposure to RF radiation following treatment with CP or 4NQO (Kim *et al.*, 2008a).

V79 Chinese hamster cells were exposed for 1, 2, or 3 hours to RF radiation at 935 MHz, generating an electric field-strength of 8.2 ± 0.3 V/cm and an average SAR of 0.12 W/kg. The microtubule structure in these cells was analysed by use of an immunocytochemical method. After 3 hours of exposure, microtubules in exposed cells were found to be altered compared with those in unexposed control cells. Three days after exposure, cell proliferation was significantly decreased in samples that had been exposed for 3 hours. Exposure to RF radiation at 935 MHz affects the structure of microtubule proteins, which consequently may obstruct cell growth (Pavicic & Trosic, 2008; Trosic & Pavicic, 2009).

(ii) 2450 MHz

The assay for forward mutation at the thymidine kinase locus in L5178Y mouse lymphoma cells was used to investigate the effects of a 4-hour exposure to RF radiation at 2450 MHz (power density, 48.8 mW/cm²; SAR, 30 W/kg), alone and in the presence of the chemical mutagen MMC (0.1, 0.2, 0.3 µg/ml). Exposure to RF radiation alone was not mutagenic, and it did not alter the effects of MMC with regards to cell proliferation or mutation induction (Meltz *et al.*, 1989). A similar experiment involving exposure to RF radiation combined with proflavin – a

DNA-intercalating drug – gave similar results (Meltz *et al.*, 1990).

In a cytogenetic study, CHO cells were exposed to pulsed-wave RF radiation at 2450 MHz (SAR, 33.8 W/kg), for 2 hours in the absence or presence of MMC (0.075 or 0.1 µg/ml) or adriamycin (0.175 µg/ml). The experimental conditions resulted in a maximum temperature increase of 3.2 °C. With respect to the induction of chromosomal aberrations, no effect was found that could be ascribed to the exposure to RF radiation (Kerbacher *et al.*, 1990).

CHO cells were exposed simultaneously to adriamycin (10⁻⁶ M) and pulsed-wave RF radiation at 2450 MHz (SAR, 33.8 W/kg) for 2 hours, or to adriamycin only. There was no effect of exposure to RF radiation on adriamycin-induced changes in cell progression or SCE frequency (Ciaravino *et al.*, 1991).

Micronucleus formation in Chinese hamster ovary (CHO) K1 cells was measured after exposure of the cells to RF radiation at 2450 MHz in four different scenarios: (1) exposure for 18 hours at average SARs of 13, 39 or 50 W/kg (input power, 7.8 W), which had no effect on micronucleus formation; (2) exposures corresponding to SARs of 78 or 100 W/kg (input power, 13 W), which produced a significant increase ($P < 0.01$) in micronucleus frequency; (3) treatment with the clastogenic compound bleomycin alone, or with bleomycin followed by irradiation for 18 hours at SARs of 25, 78 or 100 W/kg, which resulted in enhancement by RF radiation (at SAR values of 78 and 100 W/kg) of the effect of bleomycin alone; and (4) incubation at 39 °C for 18 hours as a high-temperature control; this last experiment also showed an increase in micronucleus frequency, albeit less strong than that after exposure to RF radiation. In a subsequent study, the authors reported a significant increase in micronucleus formation in cells exposed to RF radiation at 2450 MHz at SARs of 100 or 200 W/kg for 2 hours, but no effect of the combined exposure to RF radiation and bleomycin. Sham-exposures

at higher temperatures (38–42 °C) also increased the frequency of micronuclei, which indicates that the effects at the high SAR levels may have been thermal in nature ([Koyama et al., 2003, 2004](#)).

C3H 10T½ mouse fibroblasts were exposed to continuous-wave RF radiation at 2450 MHz (SAR, 1.9 W/kg) for 2 hours and processed for measurement of alkali-labile DNA damage and/or DNA–protein or DNA–DNA crosslinks. No effect was noted for any of these end-points ([Lagroye et al., 2004b](#)).

The induction of chromosomal aberrations was investigated in murine m5S cells exposed to continuous- or pulsed-wave RF radiation at 2450 MHz (average SARs of 5, 10, 20, 50 or 100 W/kg) for 2 hours. No significant differences were observed following exposure at any SAR compared with sham-exposed controls. There was also no difference between exposure to continuous-wave and pulsed-wave RF radiation ([Komatsubara et al., 2005](#)).

CHO-K1 cells were exposed to RF radiation at 2450 MHz (SAR, 5–200 W/kg) for 2 hours, after which *Hprt* gene mutations were scored. There was no mutation induction by exposure to RF radiation alone. An increase in the mutation frequency was found in cells exposed to RF radiation (SAR, 100 or 200 W/kg) in combination with bleomycin, but this may have been a thermal effect ([Koyama et al., 2007](#)).

(iii) 7000–9000 MHz

Cultured V79 Chinese hamster cells were exposed to continuous-wave RF radiation at 7700 MHz (power density, 30 mW/cm²) for 15, 30, or 60 minutes. In comparison with the controls, there was a higher frequency of specific chromosome lesions and a reduction in the incorporation of [³H]thymidine, showing inhibition of entry into S-phase ([Garaj-Vrhovac et al., 1990b](#)).

In a further study, the same authors reported a decrease in the number of V79 cell colonies, which was related to the power density and

the duration of exposure. Significantly higher frequencies of specific chromosomal aberrations – dicentrics, ring chromosomes – and micronuclei were observed in the exposed cells ([Garaj-Vrhovac et al., 1991](#)).

Cultures of bovine (*Bos taurus* L.) peripheral blood lymphocytes were exposed to RF radiation at 9000 MHz (SAR, 70 W/kg) for 10 minutes. To evaluate possible cooperative effects with a chemical mutagen, some exposed cultures were also treated with MMC. Exposure to RF radiation induced a statistically significant increase in micronucleus formation, both in the presence ($P < 0.01$) and absence ($P < 0.001$) of MMC ([Scarfi et al., 1996](#)).

(e) Non-mammalian cells

See [Table 4.7](#)

Mutagenic or recombinogenic effects of RF radiation at 900 MHz (GSM; SAR, 0.13 and 1.3 W/kg) were investigated in the yeast *Saccharomyces cerevisiae*. Mutation rates were monitored with a widely used gene-specific assay for forward mutation in the *CAN1* gene, which encodes arginine permease (gene-inactivating mutations lead to canavanine resistance) and with an assay measuring induction of respiration-deficient “*petite*” clones (small colonies) that have lost mitochondrial function. The recombinogenic effect of RF radiation was investigated with an assay for intrachromosomal deletion and an assay for intragenic recombination at the *ADE2* gene, which encodes an enzyme involved in purine (adenine) biosynthesis. Exposure of *S. cerevisiae* to RF radiation under these conditions did not result in recombinogenic or mutagenic effects ([Gos et al., 2000](#)).

The effects of a 40-minute exposure to pulsed-wave RF radiation at 8800 MHz (SAR, 1.6 W/kg; pulse width, 180 ns; peak power, 65 kW; repetition rate, 50 Hz) were investigated in erythrocytes of the frog *Xenopus laevis* by means of the alkaline comet assay. The temperature rise in the blood samples at steady-state was 3.5 ± 0.1 °C.

The results showed that the increase in DNA damage after exposure was associated with the increase in temperature; in this experiment, no non-thermal effects on frog erythrocytes *in vitro* were noted ([Chemeris et al., 2004](#)).

The effects of exposure to RF radiation at 835 MHz (SAR, 4 W/kg) for 48 hours were examined in assays for mutagenicity in bacteria. RF radiation was not directly mutagenic in *Salmonella typhimurium* strains TA98, TA100, TA102, TA1535, TA1537, or in *Escherichia coli* strain WP2 *uvrA*. It significantly enhanced the mutagenicity of 4NQO in *E. coli* strain WP2 *uvrA* and of cumene hydroperoxide in *S. typhimurium* strain TA102. In a test for DNA degradation, no change in the rate of degradation (formation of DNA strand breaks) was observed with plasmid pBluescript SK(+) exposed to H₂O₂ (Fenton-type reaction) as an indicator ([Chang et al., 2005](#)).

Mutagenicity tests were conducted in different bacterial strains (*S. typhimurium* TA98, TA100, TA1535 and TA1537, and *E. coli* WP2 *uvrA*) exposed to RF radiation at 2450 MHz (SAR, 5–200 W/kg) for 30 minutes. No effects were found in any of the strains tested ([Koyama et al., 2007](#)).

[The Working Group noted that while several studies showed positive responses at high SAR values, some of these were due to thermal effects. The Working Group concluded that there was weak evidence that exposure to RF radiation is genotoxic in experimental systems in mammalian and non-mammalian cells *in vitro*.]

4.2 Effects of low-level exposure to RF radiation on the immune system

In this section, some studies that assess the effects of RF radiation on the immune system are discussed (see review by [Jauchem, 2008](#)).

4.2.1 Immunotropic effects of exposure to RF radiation in humans

[In general, occupational studies in this Section included small numbers of subjects and generally failed to control for possible confounders.]

[Dmoch & Moszczyński \(1998\)](#) measured immunoglobulin concentrations and proportions of different subsets of T lymphocytes in blood samples from 52 workers at television-retransmission and satellite-communication centres, exposed to RF radiation at 6–12 GHz. Concentrations of IgG and IgA immunoglobulins, and cell counts of total lymphocytes and T8 lymphocytes were increased, whereas the number of natural killer (NK) cells and the ratio of T-helper/T-suppressor cells were decreased, compared with the values in 30 non-exposed controls. There was no change in IgM concentrations. In an extension of this study, [Moszczyński et al. \(1999\)](#) performed a similar analysis with blood samples from radar operators. In this case, IgM concentrations were elevated and T8 lymphocyte cell-counts were decreased. The different results obtained in these two professional groups with respect to immunological parameters and blood-cell counts suggested that the effect of RF radiation on the immune system depends on the character of the exposure.

[Tuschl et al. \(1999\)](#) investigated the effects of long-term handling of various types of diathermy equipment – operating at frequencies of 27, 434, or 2450 MHz – on the immune system of medical personnel, by analysis of blood samples collected from physiotherapists operating these devices. Eighteen exposed subjects and 13 controls matched for sex and age were examined. Total leukocyte/lymphocyte counts and the proportion of leukocyte subpopulations were determined by use of flow cytometry and monoclonal antibodies to cell-surface antigens. In addition, lymphocyte activity was measured to quantify subpopulations of immunocompetent cells.

Lymphocytes were stimulated by the mitogen PHA and proliferation was measured by flow cytometry. No statistically significant differences between the exposed personnel and the controls were found. In both groups, all immune parameters were within normal ranges.

[Radon et al. \(2001\)](#) investigated the effects of RF radiation at 900 MHz (pulse frequency, 217 Hz; power density, 1 W/m²) used in modern digital wireless telecommunication (GSM standard), in eight healthy male volunteers exposed in a specifically designed, shielded experimental chamber. The circularly polarized electromagnetic field applied was transmitted by an antenna positioned 10 cm behind the head of the volunteer, who was sitting upright. In double-blind trials, each volunteer underwent a total of 20 randomly allotted 4-hour periods of exposure and sham exposure, equally distributed during day and night. The salivary concentrations of IgA – as well as those of melatonin, cortisol and neopterin – did not differ significantly between the exposed and the sham-exposed subjects.

[Yuan et al. \(2004\)](#) investigated the effect of low-intensity, 170 MHz RF radiation on immune parameters in occupationally exposed workers. Blood-sample analysis showed no marked change in IgA concentrations, whereas those of IgM and IgG were significantly increased ($P < 0.01$) in the exposed group compared with those in non-exposed controls.

[Kimata \(2005\)](#) exposed 15 patients with atopic eczema dermatitis syndrome (AEDS) to RF radiation from a mobile phone (SAR, 1.62 W/kg) for 30 minutes. A second group of 15 patients was sham-exposed. In a repeat experiment 2 weeks later, the groups were switched with respect to exposure/sham-exposure. Before and after each study, mononuclear cells were stimulated with latex, the allergen to which the patients were sensitive. The production of latex-specific immunoglobulin E (IgE) was significantly increased ($P < 0.01$) after exposure to RF radiation.

[The Working Group noted that studies of humans exposed to RF radiation provided weak evidence for effects on the humoral immune system.]

4.2.2 Immunotropic effects of exposure to RF radiation in experimental animals: studies in vivo

See [Table 4.8](#)

(a) Mouse

[Smiałowicz et al. \(1983\)](#) exposed male CBA/J mice to 2450 MHz continuous-wave RF radiation (power density, 5, 15, 30 mW/cm²; SAR, 3.5, 10.5, 21 W/kg, respectively) for 90 minutes per day for 2 or 9 days, and studied the effects on the activity of NK cells and the mitogen-induced response of lymphocytes. There was no consistent difference in the mitogen response of spleen cells from irradiated mice and sham-irradiated mice, while a significant suppression of NK activity was seen at the highest exposure intensity. NK activity returned to normal within 24 hours after exposure.

[Veyret et al. \(1991\)](#) exposed BALB/c mice to pulsed-wave RF radiation at 9400 MHz (1 μ s pulses at 1000/second), both with and without amplitude modulation (AM) by a sinusoid signal at discrete frequencies between 14 and 41 MHz. Mice were immunized with sheep erythrocytes and exposed to RF radiation (30 μ W/cm²; whole-body SAR, 0.015 W/kg) for 10 hours per day, for 5 days. The antibody response to sheep erythrocytes was measured by the plaque-forming assay. In the absence of AM, there was not much change in immune responsiveness. Exposure to RF radiation with AM at 21 or 32 MHz led to significant enhancement of the response, while there was a decrease in the number of plaque-forming cells with AM at 14, 36, or 41 MHz.

[Elekes et al. \(1996\)](#) studied the effects of continuous-wave (CW) or amplitude-modulated (AM) RF radiation at 2450 MHz in male

Table 4.8 Immunotropic effects of exposure to radiofrequency radiation in experimental animals *in vivo*

Experimental system	Exposure conditions	Results	Reference
CBA/J mice	2450 MHz PW; SAR, 3.5, 10.5 and 21 W/kg; 1.5 h/d for 2, 3, 9 d	No increase in mitogenic response of splenic lymphocytes	Smiałowicz <i>et al.</i> (1983)
BALB/c mice	9400 MHz PW, AM; 30 μ W/cm ² ; whole-body SAR, ~0.015 W/kg; 10 h/d for 5 d	Significant increase in numbers of PFC at AM frequencies 21 and 32 MHz; significant decrease at 14, 36, 41 MHz.	Veyret <i>et al.</i> (1991)
BALB/c mice	2450 MHz CW or AM (50 Hz square wave); SAR, 0.14 W/kg; 3 h/d for 6 d	Increase in the number of antibody-producing cells in the spleen of male mice; no effect in female mice.	Elekes <i>et al.</i> (1996)
C57BL/6 mice	900 MHz (GSM); SAR, 1 or 2 W/kg; 2 h/d for 1, 2, 4 wk	No substantial effect on T- and B-cell compartments. Transient increase of interferon- γ after 1 week of exposure, not at 2 or 4 wk	Gatta <i>et al.</i> (2003)
Mice [strain not given]	42 GHz; 105 μ W/cm ² ; 20 min/d for 1–14 d	Strong effect on indices of non-specific immunity. Phagocytic activity of neutrophils was suppressed by 45–50% within 2–3 h after a single exposure, remained suppressed for 1 d, and was restored to normal during 3 d. Blood leukocytes were increased after exposure for 5 d.	Kolomytseva <i>et al.</i> (2002)
NMR1 mice, exposed in the far-field zone of horn antenna	42 GHz; 150 μ W/cm ² ; 20 min (single exposure), 20 min/d for 5 or 20 successive days, before or after immunization	No effect of single exposure or five repeat exposures. Daily exposure for 20 d before immunization with SRBC resulted in significant reductions in thymic and renal cellularity	Lushnikov <i>et al.</i> (2001)
C57BL/6 mice	900 MHz (GSM); whole-body average SAR, 2 W/kg; 2 h/d for 4 wk	No changes in frequencies of various B cell types or in IgM/IgG serum levels. Production of IgM/IgG by B cells from exposed mice, challenged <i>in vitro</i> with lipopolysaccharides, was comparable to that in controls	Nasta <i>et al.</i> (2006)
NMRI mice	1.8–81.5 GHz; 1 μ W/cm ² ; 5 h	Increased production of TNF in peritoneal macrophages and splenic T lymphocytes. Increased mitogenic response in T lymphocytes.	Novoselova & Fesenko (1998) , Novoselova <i>et al.</i> (1999)
NMRI mice	8.15–18 GHz; 1 μ W/cm ² ; 5 h –7 d	Increased NK cell activity, which persisted up to 24 h after exposure. Increased TNF production in peritoneal macrophages and splenic T lymphocytes after exposures of 5 h – 3 d, and reduced TNF production in peritoneal macrophages after an exposure of 7 d.	Fesenko <i>et al.</i> (1999b)
Rats [strain not given]	2450 MHz PW; SAR, 0.15–0.4 W/kg; 25 mo	Transient increase in the number of B and T lymphocytes and their response to the mitogen PHA after exposure for 13 mo	Guy <i>et al.</i> (1985)
Sprague-Dawley rats	900 MHz (GSM); SAR, 0.075 and 0.27 W/kg; 2h/d for 10 d	No alterations in the surface phenotype of splenic lymphocytes or in their concavalin A-stimulated mitogenic activity	Chagnaud & Veyret (1999)
Belgian White rabbits	2.1 GHz; 5 mW/cm ² ; 3 h/d, 6 d/wk for 3 mo	Suppression of T-lymphocyte numbers at 2 mo; stronger response of T-cell-mediated immunity (delayed-type hypersensitivity response)	Nageswari <i>et al.</i> (1991)

AM, amplitude modulation; CW, continuous wave; d, day; GSM, Global System for Mobile Communications; h, hour; LPS, lipopolysaccharides; min, minute; mo, month; MW, microwave; NK, natural killer; PHA, phytohaemagglutinin; PFC, plaque-forming cells; PW, pulsed-wave; TNF, tumour necrosis factor; wk, week.

and female BALB/c mice. The time-averaged power density was $100 \mu\text{W}/\text{cm}^2$, with a SAR of $0.14 \pm 0.02 \text{ W}/\text{kg}$. Exposure to RF radiation as CW or AM (3 hours per day for 6 days) induced a non-significant increase in the number of antibody-producing cells in the spleen of male mice. No effects were seen in female mice.

[Novoselova & Fesenko \(1998\)](#) and [Novoselova et al. \(1999\)](#) exposed male NMRI mice to RF radiation at 8150–18 000 MHz (power density, $1 \mu\text{W}/\text{cm}^2$) for 5 hours, and observed a significantly enhanced ($P < 0.05$) production of TNF in peritoneal macrophages and in T-cells in the spleen, and an increased mitogenic response in T lymphocytes.

Male NMRI mice received whole-body exposure to RF radiation at 10 GHz (average power density, $1 \mu\text{W}/\text{cm}^2$) for different time periods (1 hour to 7 days). A significant enhancement of the production of tumour necrosis factor (TNF) in peritoneal macrophages and in splenic T lymphocytes was seen after exposures of 5–72 hours. Prolonged irradiation after 72 hours resulted in a decrease in production of TNF. In mice exposed to RF radiation at 8.15–18 GHz (average power density, $1 \mu\text{W}/\text{cm}^2$) for 24 hours, TNF production in T-cells and macrophages was significantly increased ($P < 0.05$); in the latter cell type, this increase persisted for 3 days after termination of exposure ([Fesenko et al., 1999b](#)).

[Lushnikov et al. \(2001\)](#) exposed male NMRI mice to RF radiation at 42.0 GHz (energy-flux density, $150 \mu\text{W}/\text{cm}^2$) for 20 minutes per day, on five or twenty successive days before immunization with sheep erythrocytes, or for 20 minutes per day during five successive days after immunization. The response was estimated on day 5 after immunization by the number of antibody-forming splenic cells and by antibody titres. Humoral immunity and cellularity of the lymphoid organs did not change significantly after the single exposure, or after the series of five exposures before and after immunization. However, after daily exposure for 20 days before

immunization, statistically significant reductions ($P < 0.05$) of thymic and splenic cellularity were observed.

[Kolomytseva et al. \(2002\)](#) exposed mice to RF radiation at 4200 MHz (power density, $150 \mu\text{W}/\text{cm}^2$) for 20 minutes. The phagocytic activity of neutrophils was suppressed by about 50% in the 2–3 hours after a single exposure. The effect persisted for 1 day, and phagocytic activity then returned to normal within 3 days. A significant modification of the leukocyte profile in mice exposed for 5 days was observed after cessation of exposure: the number of leukocytes increased, mostly due to an increase in lymphocyte content.

[Gatta et al. \(2003\)](#) exposed C57BL/6 mice to GSM-modulated RF radiation at 900 MHz (SAR, 1 or 2 W/kg) for 2 hours per day for 1, 2 or 4 weeks. The number of spleen cells, the percentage of B and T-cells, and the distribution of T-cell subpopulations (CD4 and CD8) were not affected by the exposure. There was no difference in stimulation of T or B lymphocytes with specific monoclonal antibodies or lipopolysaccharides (LPS) between sham-exposed and exposed mice. After 1 week of exposure at a SAR of 1 or 2 W/kg, there was an increase in the production of interferon-gamma (IFN- γ), which was no longer observed when exposure was prolonged to 2 or 4 weeks.

[Nasta et al. \(2006\)](#) examined the effects of GSM-modulated RF radiation at 900 MHz (average SAR, 2 W/kg) on peripheral differentiation of B-cells and antibody production in female C57BL/6 mice exposed *in vivo*. Whole-body exposure for 2 hours per day, for 4 weeks, did not affect the frequencies of T1 and T2 B-cells, or of mature follicular B-cells and marginal zone B-cells in the spleen. Serum concentrations of IgM and IgG were not significantly affected. B-cells from mice exposed to RF radiation, which were then challenged *in vitro* with lipopolysaccharide (LPS) produced comparable amounts of IgM and IgG. Exposure to RF radiation did not alter the

ongoing antigen-specific immune response in immunized mice.

(b) *Rat*

In a study with rats receiving lifelong exposure to pulsed-wave RF radiation at 2450 MHz (SAR, 0.15–0.4 W/kg), [Guy et al. \(1985\)](#) found a significant increase in the number of splenic B and T lymphocytes at 13 months, but this effect had disappeared by the end of the study at 25 months. The exposed rats also showed a significant increase in their response to LPS and pokeweed mitogen after 13 months of exposure (no data available at 25 months).

[Chagnaud & Veyret \(1999\)](#) examined the effects of exposure to GSM-modulated RF radiation at 900 MHz (55 and 200 $\mu\text{W}/\text{cm}^2$; SAR, 0.075 and 0.279 W/kg; repetition rate, 217 Hz) for 2 hours per day for 10 days, on lymphocyte subpopulations in female Sprague-Dawley rats. The mitogenic response of the exposed rats was analysed by flow cytometry and a colorimetric method. No alterations were found in cell-surface markers (CD4, CD8 and IaAg) of splenic lymphocytes of exposed rats, or in their mitogenic activity when stimulated with concanavalin A.

(c) *Rabbit*

[Nageswari et al. \(1991\)](#) exposed male Belgian White rabbits to RF radiation at 2100 MHz (power density, 5 mW/cm^2 ; calculated average SAR, 0.83 W/kg) for 3 hours per day, 6 days per week, for 3 months, in specially designed miniature anechoic chambers. One group of rabbits was tested for T-lymphocyte-mediated cellular immune-response, being initially sensitized with bacille Calmette–Guérin (BCG) vaccine and challenged with tuberculin after termination of exposure. A second group was assessed for B-lymphocyte-mediated humoral immune-response. Samples of peripheral blood were collected each month during exposure or sham exposure and during follow-up at 5 and 14 days

after termination of exposure (second group only). Significant suppression of numbers of T lymphocytes was noted in the exposed rabbits at 2 months and during the follow-up period. Rabbits in the group initially sensitized with BCG showed an increase in foot-pad thickness, which is indicative of a good T-lymphocyte-mediated immune response (a delayed-type hypersensitivity response).

[The Working Group noted that the available evidence from the numerous experimental studies *in vivo* that have assessed the effects of short-term and prolonged low-level exposure to RF radiation on the function and status of the immune system, clearly indicates that various shifts in the number and/or activity of immunocompetent cells can be detected. However, results have been inconsistent between experiments, despite comparable exposure conditions at similar intensities and radiation parameters. Short-term exposure to weak RF fields may temporarily stimulate certain humoral or cellular immune functions, while prolonged irradiation inhibits the same functions. The relevance of these observations to carcinogenicity was unclear.]

4.2.3 *Immunotropic effects of exposure to RF radiation in experimental systems: studies in human cells in vitro*

See [Table 4.9](#)

[Cleary et al. \(1990\)](#) studied human peripheral blood cells that were sham-exposed or exposed *in vitro* to RF radiation at 27 MHz (SAR, 0–196 W/kg) or 2450 MHz (SAR, 0–50 W/kg) for 2 hours under isothermal conditions (37 ± 0.2 °C). Immediately after exposure, peripheral blood mononuclear cells were isolated by Ficoll density-gradient centrifugation and cultured for 3 days at 37 °C with or without mitogenic stimulation by PHA. Lymphocyte proliferation was assayed at the end of the culture period by a 6-hour pulse-labelling with [^3H]thymidine. Exposure to radiation at

Table 4.9 Immunotropic effects of exposure to radiofrequency radiation in experimental systems *in vitro*

Experimental system	Exposure conditions	Results	Reference
Mouse PBMC; assessment of IL-2-dependent cytolytic T-lymphocyte proliferation (CTLL-2)	2450 MHz, CW (SAR, 5–50 W/kg) or PW (SAR, 5 W/kg), for 2 h	Statistically significant reduction in CTLL-2 proliferation after CW-RF radiation at low IL-2 levels and at SAR ≥ 25 W/kg; increase after PW-RF radiation	Cleary et al. (1996)
Rat basophilic leukaemia RBL-2H3 cells (a mast cell line)	835 MHz; 81 W/m ² ; 3 × 20 min/d for 7 d	From day 4 onwards, the rates of DNA synthesis and cell replication continued to increase in exposed cells, but decreased in controls; cell morphology was also altered	Donnellan et al. (1997)
Human PBMC, microculture with mitogen (PHA) stimulation	27 MHz (SAR, 0–196 W/kg) or 2450 MHz (SAR, 0–50 W/kg); isothermal conditions (37 ± 0.2 °C); 2 h	Dose-dependent, statistically significant increase in [³ H] thymidine uptake in PHA-activated or unstimulated lymphocytes at SAR < 50 W/kg; uptake was suppressed at SAR ≥ 50 W/kg	Cleary et al. (1990)
Human lymphocytes; transformation of PBMC exposed to RF radiation or heated conventionally	2450 MHz CW or PW, at non-heating (37 °C) and various heating levels (temperature increases of 0.5, 1.0, 1.5, and 2 °C); SARs up to 12.3 W/kg	Both conventional and CW heating enhanced cell transformation to the same extent, which was correlated with the increase in incubation temperature. Exposure to PW RF radiation enhanced transformation at non-heating conditions.	Czerska et al. (1992)
Human mast cell line, HMC-1	864.3 MHz; average SAR, 7 W/kg; 3x20 min/d for 7 d	Effect on localization of protein kinase C (migration towards the cell membrane), upregulation of <i>c-kit</i> , down-regulation of <i>NDPK</i> -beta, and the apoptosis-associated gene <i>DAD-1</i> .	Harvey & French (1999)
Human PBMC, microculture with mitogens, assessment of interleukin release, T-cell suppression (SAT)	1300 MHz PW; SAR, 0.18 W/kg; 1 h	Decreased spontaneous incorporation of [³ H]thymidine; no change in response to PHA or concanavalin A; no change in SAT index and saturation of IL-2 receptors; production of IL-10 by lymphocytes increased. Pulse-modulated MWs have immunotropic effects.	Dąbrowski et al. (2003)
Human lymphocytes; analysis of CD25, CD95, CD28 antigens in unstimulated and stimulated CD4+ or CD8+ T-cells from PBMC	1800 MHz (10 min on, 20 min off); SAR, 2 W/kg; 44 h. Microculture with or without antibody anti-CD3 mitogenic stimulation	No significant difference in proportion of cell subsets between exposed and sham-exposed lymphocytes from young or elderly donors. Slight but significant downregulation of CD95 expression in stimulated CD4+ T lymphocytes from elderly (average age, 88 yr) but not from younger (average age, 26 yr) donors.	Capri et al. (2006)

Table 4.9 (continued)

Experimental system	Exposure conditions	Results	Reference
Human PBMC, microculture with mitogens, assessment of interleukin (IL) release, T-cell suppression (SAT)	900 MHz (GSM); SAR, 0.024 W/kg; 15 min	Significantly increased response to mitogens and enhanced immunogenic activity of monocytes (LM index). The results suggest that immune activity of responding lymphocytes and monocytes can be enhanced by 900 MHz MW.	Stankiewicz <i>et al.</i> (2006)
Human PBMC, microculture with mitogens, assessment of several immune functions	1950 MHz (GSM; 5 min on, 10 min off); SAR, 1 W/kg; 8 h	No effects of RF radiation on immune functions: (i) the intracellular production of IL-2 and INF- γ in lymphocytes, and IL-1 and TNF- α in monocytes; (ii) the activity of immune-relevant genes (IL 1- α and β , IL-2, IL-2-receptor, IL-4, MCSF-receptor, TNF- α , TNF- α -receptor); or (iii) the cytotoxicity of lymphokine-activated killer cells (LAK cells) against a tumour cell line.	Tuschl <i>et al.</i> (2006)

d, day; h, hour; IL-2, interleukin 2; IL-10, interleukin 10; INF- γ , interferon γ ; LM, lymphocytes-monocytes; MCSF, macrophage colony-stimulating factor; MW, microwave; min, minute; mo, month; NDPK, nucleoside diphosphate kinase; PBMC, peripheral blood mononuclear cells; PHA, phytohaemagglutinin; PW, pulsed-wave; SAR, specific absorption rate; SAT index, a measure of the suppressive activity of T cells; TNF, tumour necrosis factor; yr, year

either frequency at SARs < 50 W/kg resulted in a dose-dependent, statistically significant increase in [³H]thymidine uptake in PHA-activated or non-stimulated lymphocytes. Exposure at SARs of ≥ 50 W/kg suppressed [³H]thymidine uptake. There were no detectable effects of RF radiation on lymphocyte morphology or viability.

[Czerska et al. \(1992\)](#) determined the effects of continuous- and pulsed-wave RF radiation at 2450 MHz (average SARs up to 12.3 W/kg) on spontaneous lymphoblastoid transformation of human lymphocytes *in vitro*. Peripheral blood mononuclear cells from healthy donors were exposed for 5 days to conventional heating, or to continuous- or pulsed-wave RF radiation at 2450 MHz under non-heating (37 °C) or various heating conditions (temperature increases of 0.5, 1.0, 1.5, or 2 °C). The pulsed exposures involved pulse-repetition frequencies from 100 to 1000 pulses per second at the same average SARs as the continuous exposures. At the end of the incubation period, spontaneous lymphoblastoid-cell transformation was detected by use of an image-analysis system. At non-heating levels, continuous-wave exposure did not affect transformation compared with sham-exposed cultures. Under heating conditions, both conventional heating and exposure to continuous-wave RF radiation enhanced transformation to the same extent, and correlated with the increases in incubation temperature. Exposure to pulsed-wave RF radiation enhanced transformation under non-heating conditions. At heating levels, it enhanced transformation to a greater extent than did conventional heating or continuous-wave exposure. The results indicate that pulsed-wave RF radiation at 2450 MHz had a different action on the process of lymphoblastoid cell transformation *in vitro* than continuous-wave radiation at 2450 MHz and at the same average SARs.

Human HMC-1 mast cells were exposed to RF radiation at 846.3 MHz (average SAR, 7.3 W/kg) for 20 minutes, three times per day

(at 4-hour intervals) for 7 days. During the 20 minutes of exposure, the cells were outside the incubator and the temperature in the cell-culture medium dropped to 26.5 °C. Effects were seen on the localization of protein kinase C (migration to the cell membrane), and on expression of three genes: the proto-oncogene *c-kit* (upregulated 36%), the gene encoding transcription factor nucleoside diphosphate kinase B (downregulated 38%), and the apoptosis-associated gene *DAD-1* (downregulated 47%) ([Harvey & French, 1999](#)).

[Dąbrowski et al. \(2003\)](#) exposed peripheral blood mononuclear cells from healthy donors ($n = 16$) to pulse-modulated RF radiation at 1300 MHz (power density, 1 mW/cm²; SAR, 0.18 W/kg) for 1 hour. This exposure decreased the spontaneous incorporation of [³H]thymidine, but the proliferative response of lymphocytes to PHA and concavalin A, the T-cell suppressive activity (SAT index), and the saturation of IL-2 receptors did not change. The IL-10 production by the lymphocytes increased ($P < 0.001$), and the concentration of interferon-gamma (IFN γ) remained unchanged or slightly decreased in the culture supernatants. Exposure to RF radiation modulated monokine production by monocytes. The production of IL-1 β increased significantly, the concentration of its antagonist (IL-1ra) dropped by half and the concentration of tumour necrosis factor α (TNF- α) remained unchanged. These changes in monokine proportion (IL-1 β versus IL-1ra) resulted in a significant increase in the immunogenic activity of the monocytes, *i.e.* the influence of monokines on the lymphocyte mitogenic response, which reflects the activation of monocyte immunogenic function. The results indicated that pulse-modulated microwaves have the potential to influence immune function, stimulating preferentially the immunogenic and pro-inflammatory activity of monocytes at relatively low levels of exposure.

[Capri et al. \(2006\)](#) analysed CD25, CD95, CD28 molecules in non-stimulated and stimulated CD4+ or CD8+ T-cells *in vitro*. Peripheral

blood mononuclear cells from 10 young (age, 26 ± 5 years) and 8 elderly (age, 88 ± 2 years) donors were sham-exposed or exposed to intermittent (10 minutes on, 20 minutes off) RF radiation at 1800 MHz (SAR, 2 W/kg) for 44 hours, with or without mitogenic stimulation. No significant changes in the percentage of these subsets of cells were found between exposed and sham-exposed non-stimulated lymphocytes in young or elderly donors. A small, but statistically significant downregulation of CD95 expression was noted in stimulated CD4+ T lymphocytes from elderly, but not from younger donors, after exposure to RF radiation.

[Stankiewicz et al. \(2006\)](#) investigated whether cultured human immune cells induced into the active phases of the cell cycle (G1, S) were sensitive to exposure to RF radiation at 900 MHz (GSM; 27 V/m; SAR, 0.024 W/kg) for 15 minutes. The exposed microcultures of peripheral blood mononuclear cells showed a significantly higher proliferative response to PHA or concanavalin A, a stronger response to mitogens, and a higher immunogenic activity of monocytes than sham-exposed control cultures.

[Tuschl et al. \(2006\)](#) exposed peripheral blood mononuclear cells to RF radiation at 1950 MHz, with a SAR of 1 W/kg, in an intermittent mode (5 minutes on, 10 minutes off) for 8 hours. Numerous immune parameters were evaluated, including: intracellular production of IL-2 and INF γ in lymphocytes, and IL-1 and TNF- α in monocytes; activity of immune-relevant cytokines (IL-1- α and β , IL-2, IL-2-receptor, IL-4, macrophage colony-stimulating factor (MCSF)-receptor, TNF- α , TNF- α -receptor); and cytotoxicity of lymphokine-activated killer cells (LAK cells) against a tumour cell line. For each parameter, blood samples from at least 15 donors were evaluated. No statistically significant effects of exposure were found.

[The Working Group concluded that exposure *in vitro* to non-thermal intensities of RF

radiation provided weak evidence for effects on immunocompetent cells.]

4.3 Effects of exposure to RF radiation on gene and protein expression

4.3.1 Gene expression

(a) Humans

There were no studies examining gene or protein expression after exposure to RF radiation in humans.

(b) Experimental animals

See [Table 4.10](#)

(i) *Caenorhabditis elegans*

No effect was found on the transgene expression of *hsp16* (encoding heat-shock protein hsp16, the equivalent of human hsp27) in the nematode *C. elegans* – transgenic for *hsp16* – exposed to continuous-wave or pulsed-wave RF radiation at 1.8 GHz (SAR, 1.8 W/kg) for 2.5 hours at 25 °C ([Dawe et al., 2008](#)). In a second study, *C. elegans* was exposed to continuous-wave RF radiation at 1 GHz (SAR, 0.9–3 mW/kg; power input, 0.5 W) for 2.5 hours at 26 °C. In this exposure set-up, with very low SAR, the difference in temperature between exposed and sham-exposed samples did not exceed 0.1 °C. In a gene-expression array, no statistically significant effects on the gene-expression pattern were found ([Dawe et al., 2009](#)). [The Working Group noted that experiments at these low SAR levels may favour a no-effect outcome.]

(ii) *Drosophila melanogaster*

Using a semiquantitative reverse-transcriptase polymerase chain reaction (RT-PCR), [Lee et al. \(2008\)](#) showed that exposure of fruit flies (*D. melanogaster*) to RF radiation at 835 MHz (SAR, 1.6 or 4.0 W/kg) for up to 36 hours (resulting in 90% or 10% survival, respectively, at low and high SAR) affected the

Table 4.10 Effects on gene expression in animal models after exposure to radiofrequency radiation *in vivo*

Biological model	Exposure conditions	Assessment of gene expression	Results	Comments	Reference
<i>Caenorhabditis elegans</i> (strain PC72)	1800 MHz (GSM); CW or DTX; SAR, 1.8 W/kg; 2.5 h at 25 °C	Stress-inducible reporter gene β -galactosidase under control of <i>hsp16</i> heat-shock promoter, measured as β -galactosidase activity	No effect on expression of <i>hsp16</i>		Dawe et al. (2008)
<i>Caenorhabditis elegans</i> wild-type (N2)	1000 MHz (CW); SAR, 0.9–3 mW/kg; 2.5 h	Affymetrix <i>C. elegans</i> Genome GeneChip array (> 22 000 probes)	21 upregulated and 6 downregulated genes; less than expected by chance		Dawe et al. (2009)
<i>Drosophila melanogaster</i> F, age 3 d	835 MHz; SAR, 1.6 and 4.0 W/kg; 12, 18, 24, 30, 36 h	Semi-quantitative RT-PCR; analysis of stress genes <i>rolled</i> (<i>Erk</i>), <i>Jra</i> (<i>Jun</i>), <i>Dfos</i> (<i>Fos</i>) and apoptosis-related genes: <i>Bcl2</i> , <i>Dmp53</i> (<i>TP53</i>), <i>reaper</i> , <i>hid</i>	Increased expression of <i>rolled</i> (1.6 W/kg) and <i>Jra</i> and <i>Dfos</i> (4.0 W/kg); protein-expression changes confirmed gene-expression changes; increased expression of <i>Bcl2</i> (1.6 W/kg) and <i>Dmp53</i> , <i>reaper</i> , <i>hid</i> (4.0 W/kg)		Lee et al. (2008)
Mouse brain (BALB/c) age, 5–6 wk	800 MHz (GSM); SAR, 1.1 W/kg (whole-body); SAR, 0.2 W/kg (brain); 1 h	Affymetrix Mouse Expression Array 430A (22 600 probe sets)	Filtering microarray results for fold-changes > 1.5 and > 2.0 provided; respectively 301 and 30 differentially expressed probe sets	No consistent evidence of modulation of gene expression in whole brain	Paparini et al. (2008)
Rat brain (Wistar, M)	900 MHz (GSM); SAR, 0.3 or 1.5 W/kg; 900 MHz (CW), SAR, 7.5 W/kg; 4 h	Gene expression assessed immediately after exposure. Hybridization <i>in situ</i> ; <i>hsp70</i> , <i>c-fos</i> , <i>c-jun</i> , <i>GFAP</i> ; optical-density analysis	<i>hsp70</i> mRNA: increase at 7.5 W/kg (CW); <i>c-fos</i> mRNA: increase at all exposures; <i>c-jun</i> mRNA: decline at 1.5 W/kg (GSM) and 7.5 W/kg (CW). <i>GFAP</i> mRNA: no effect	Exposure by use of a mobile phone	Fritze et al. (1997a)
Rat brain (F344)	1600 MHz; SAR, 0.16, 1.6, 5 W/kg; 2 h	Northern blot for ornithine decarboxylase, <i>Fos</i> and <i>Jun</i> in total brain RNA; normalization to α -actin probe	No effect on mRNA expression		Stagg et al. (2001)
Rat brain (F344)	915 MHz GSM (DTX); average whole-body SAR, 0.4 W/kg; 2 h	Affymetrix U34A GeneChip (8800 genes)	11 upregulated genes; 1 downregulated gene		Belyaev et al. (2006)

Table 4.10 (continued)

Biological model	Exposure conditions	Assessment of gene expression	Results	Comments	Reference
Rat brain (F344)	1800 MHz (GSM); whole-body SAR, 0.013 W/kg (brain SAR, 0.03 W/kg); 6 h	Affymetrix rat 2302 chip (31 099 genes); categories: upregulated > 1.05-fold; downregulated < 0.95-fold; unaffected, 0.95–1.05-fold	Numerous upregulated and downregulated genes in nearly all 4956 gene ontologies analysed, especially regulatory genes of membrane integrity and cell signalling.	Less reliable due to small “fold-change” criteria; information on affected genes not given	Nittby et al. (2008)
Rat brain, facial nerves (Sprague-Dawley)	1.9 GHz (GSM); SAR, 0.9, 1.18, 1.8 W/kg; 6 h/d, for 126 d	RT-PCR analysis of mRNA for calcium ATPase, N-CAM, NGF-B, VEGF in brain and in facial nerves	Statistically significant upregulation of all mRNAs	Radiation source was a mobile phone; less reliable dosimetry	Yan et al. (2008, 2009)
Rat (newborn) kidney (pregnant Sprague-Dawley rats)	9.4 GHz (GSM); SAR, 0.5 mW/kg; continuously on days 1–3 or 4–7 after mating	RT-PCR analysis of mRNA expression of bone morphogenetic proteins (Bmp) and their receptors (Bmpr)	Increased mRNA expression of Bmp4 and Bmpr1a, and decreased expression of Bmpr2 in kidneys of newborns from rats exposed on days 1–3 or 4–7 of gestation. No effect on expression of Bmp7.	These changes may reflect a delay in renal development	Pyrpasopoulou et al. (2004)

CW, continuous wave; d, day; DTX, discontinuous transmission mode; GSM, Global System for Mobile communication; h, hour; N-CAM, neural cell-adhesion molecule; NGF, neural growth factor; RT-PCR, reverse-transcriptase polymerase chain reaction; SAR, specific absorption rate; VEGF, vascular endothelial growth factor; wk, week

expression of genes encoding stress-response kinases and proteins involved in the regulation of apoptosis. Interestingly, some of these genes – involved in cell-survival signalling pathways – responded to the lower SAR, while others – involved in apoptotic pathways – were activated by the higher SAR. The changes in gene expression were followed by similar changes in expression of the corresponding proteins ([Table 4.11](#)), which strengthens the validity of the findings.

(iii) Mouse

[Paparini et al. \(2008\)](#) exposed BALB/c mice to RF radiation at 1800 MHz (whole-body SAR, 1.1 W/kg; brain-averaged SAR, 0.2 W/kg) for 1 hour, and analysed gene expression in total brain homogenate. The array analysis did not show any significant modulation of gene expression in the exposed mice compared with sham-exposed controls. Under less stringent conditions, 42 genes were found to be upregulated, while 33 were downregulated. However, these results could not be confirmed with RT-PCR. [The Working Group noted that analysing mRNA from a whole-brain homogenate might obscure the detection of any effect in specific brain regions.]

(iv) Rat

Groups of 30 male Wistar rats were exposed to RF radiation at 900 MHz (GSM; brain-averaged SAR, 0.3 or 1.5 W/kg) or to continuous-wave RF radiation at 900 MHz (brain-averaged SAR, 7.5 W/kg), for 4 hours. To mimic actual life exposure as closely as possible, the signal was generated with a commercial mobile GSM phone, and a telephone conversation was simulated by repeatedly playing the first half of H. von Kleist's comedy *Der zerbrochene Krug* ([Von Kleist, 1811](#)). Subgroups of 10 rats were processed immediately after exposure, or 24 hours or 7 days later. Enhanced expression of Hsp70 mRNA was observed in the brain at the higher SAR of 7.5 W/kg, and a small but significant increase

was seen in c-Fos expression in the brain at the two lower SAR values ([Fritze et al., 1997a](#)). [The Secretariat was pleased to learn that the spoken text to which the rats were exposed in this study mimicked actual life exposure of the authors, but was uncertain about confounding effects on the rat brain.]

Fischer 344 rats were exposed to RF radiation at 1600 MHz (brain-averaged SAR, 0.16, 1.6, and 5.0 W/kg) for 2 hours. No changes were seen in core body temperature and corticosterone or adrenocorticotrophic hormone levels in the brain that could be attributed to exposure to RF radiation. Also the levels of *Odc*, *Fos* and *Jun* mRNA in brain tissue showed no differences with sham-exposed controls that could be ascribed to RF radiation ([Stagg et al., 2001](#)).

Three groups of pregnant Wistar rats were sham-exposed, or exposed to pulsed-wave RF radiation at 9.4 GHz (SAR, 0.5 mW/kg) continuously during days 1–3 after mating, or during days 4–7 after mating, respectively. In 20–26 newborns collected from each of these groups, significantly altered expression and localization of proteins involved in bone morphogenesis were observed in the kidney. These changes may reflect a delay in renal development ([Pyrpasopoulou et al., 2004](#)).

Whole-body exposure of Fischer 344 rats to RF radiation at 915 MHz (GSM; SAR, 0.4 W/kg) for 2 hours led to significantly ($P < 0.0025$) increased expression (1.34–2.74-fold) of eleven genes and reduced expression (0.48-fold) of one gene in the cerebellum of the exposed rats. Only these genes showed significantly increased/decreased expression in all nine comparisons between three exposed and three sham-exposed rats ([Belyaev et al., 2006](#)).

[Nittby et al. \(2008\)](#) reported a strong response and changes in the expression of numerous genes after whole-body exposure of Fischer 344 rats to RF radiation at 1800 MHz (GSM; SAR, 13 mW/kg) for 6 hours. In this study, changes in gene expression were considered when expression

Table 4.11 Effects on protein expression in human and animal models after exposure to radiofrequency radiation *in vivo*

Biological model	Exposure conditions	Assessment of protein expression	Results	Comments	Reference
Human skin, female volunteers	900 MHz (GSM); SAR, 1.3 W/kg; local exposure, 1 h; punch-biopsies collected immediately after exposure	Protein expression by 2DE-based proteomics	Expression was significantly increased for 7 proteins, reduced for 1; 2 proteins – one up, one down – were affected in all 10 volunteers	Proteins not identified	Karinen et al. (2008)
<i>Drosophila melanogaster</i>	1900 MHz (GSM); SAR, 1.4 W/kg; 2 × 1 h per day for 10 d	Immunocytochemistry; serum response element (SRE)-binding, ELK1 phosphorylation, hsp70	Increase in expression of all measured proteins	Unreliable dosimetry: exposure by placing vials next to mobile-phone antenna; unreliable data analysis, single experiments; no statistical analysis	Weisbrot et al. (2003)
<i>Drosophila melanogaster</i>	835 MHz; SAR, 1.6 and 4.0 W/kg; 12, 18, 24, 30, 36 h	Immunocytochemistry; phospho-JNK, phospho-ERK, phospho-p38MAPK	Activation of ERK (at SAR 1.6 W/kg), activation of JNK (at SAR 4.0 W/kg); no effect on p38MAPK		Lee et al. (2008)
<i>Drosophila melanogaster</i>	900 MHz; SAR 0.64 W/kg; continuous/intermittent exposure	Immunofluorescence; phalloidin detection of actin stress fibres	Increase in disorganization of actin network	Unreliable dosimetry: exposure by placing vials next to mobile-phone antenna	Chavdoula et al. (2010)
Mouse brain (C57BL/6NTac) age, 8 wk	900 MHz (GSM); SAR, 4 W/kg. Mice were restrained for 1 h during exposure; brains perfusion-fixed immediately after exposure	Immunocytochemistry; c-fos	Non-significant decline (~50%) in c-fos expression in exposed cingulate cortex; no effects in other parts of the brain	Significant difference of exposed/sham-exposed with cage-controls; effects may be due to immobilization	Finnie (2005)
Fetal mouse brain (BALB/c)	900 MHz (GSM); SAR, 4 W/kg; 1 h daily, on days 1–19 of gestation. Mice were restrained during exposure	Immunocytochemistry; c-fos	Average expression of c-fos was non-significantly increased in basal ganglion and reduced in pyriform cortex		Finnie et al. (2006a)
Mouse brain (C57BL/6NTac)	900 MHz (GSM); SAR, 4 W/kg; 1 h/d, 5 d/wk, 104 wk. Mice were restrained during exposure	Immunocytochemistry; c-fos	No effects on c-fos expression, but no numerical analysis shown	No statistical details given. Significant difference of exposed/sham-exposed with cage-controls; effects may be due to immobilization	Finnie et al. (2007)

Table 4.11 (continued)

Biological model	Exposure conditions	Assessment of protein expression	Results	Comments	Reference
Fetal mouse brain (BALB/c)	900 MHz (GSM); SAR, 4 W/kg; 1 h daily on days 1–19 of gestation. Mice were restrained during exposure	Immunocytochemistry; Hsp25, Hsp32, Hsp70	No effect on expression of Hsp; no numerical analysis shown	No statistical details given; shown only examples of stained brain slices	Finnie et al. (2009a)
Mouse brain [strain NS]	900 MHz (GSM); SAR, 4.0 W/kg; 1 h single exposure or 1 h/d, 5 d/wk, 104 wk	Immunocytochemistry; aquaporin (AQP4, marker of blood–brain barrier function)	No effect on aquaporin expression; no numerical analysis shown	No statistical details given; shown only examples of stained brain slices	Finnie et al. (2009b)
Mouse brain [strain NS]	900 MHz (GSM); SAR, 4.0 W/kg; 1 h single exposure or 1 h/d, 5 d/wk, 104 wk	Immunocytochemistry; ionized calcium-binding adaptor molecule Iba1 (microglia activation marker)	No effect on Iba1 expression		Finnie et al. (2010)
Transgenic mouse (hsp70.1-deficient)	849 MHz or 1763 MHz; whole-body average SAR, 0.04 W/kg; 2 × 45 min/d with 15-min interval, 5 d/wk, for up to 10 wk; mice killed after 4, 8, 10 wk of exposure	Immunocytochemistry: PCNA Western blot: actin, HSP90, HSP70, HSP25, ERK and phospho-ERK, JNK and phospho JNK, p38MAPK and phospho-p38MAPK	No effect on HSP90, HSP70, HSP25 expression No effect on phosphorylation of ERK, JNK and p38MAPK		Lee et al. (2005)
Mouse brain (C57BL/6N)	849 MHz or 1763 MHz; brain average SAR, 7.8 W/kg; 1 h/d, 5 d/wk, for 6 or 12 mo	Immunocytochemistry: PCNA, GFAP, NeuN	No effect on expression of PCNA, GFAP, NeuN	No numerical data, no statistical details given Visual evaluation only	Kim et al. (2008b)
Mouse brain (ICR, M)	835 MHz; SAR, 1.6 and 4.0 W/kg; whole-body exposure; 5 h (single), 1 h/d for 5 d; daily [no time given] for 1 mo (1.6 W/kg only)	Immunocytochemistry: calbindin, calretinin	Changes in expression of calbindin and calretinin after 1 mo exposure, particularly in the inner molecular layer of the dentate gyrus of the brain	Alterations in calcium-binding proteins affect cellular Ca ²⁺ levels and hippocampal functions associated with neuronal connectivity and integration	Maskey et al. (2010)
Rat brain (Wistar, M)	900 MHz (GSM, SAR 0.3 and 1.5 W/kg; CW, SAR 7.5 W/kg CW); 4 h; protein expression examined 24 h after exposure	Immunocytochemistry; c-fos, fos B, c-jun, jun B, jun D, krox-20, krox-24, Hsp70, Gfap, MHCclass II;	No effect on expression of any of the proteins examined	Exposure by use of a mobile telephone; only visual inspection and evaluation of samples; no statistical details	Fritze et al. (1997a)

Table 4.11 (continued)

Biological model	Exposure conditions	Assessment of protein expression	Results	Comments	Reference
Rat brain (F344, M)	915 MHz (GSM, DTX); average whole-body SAR, 0.4 W/kg; 2 h	Western blot: Hsp70	No effect on expression of hsp70 protein		Belyaev et al. (2006)
Rat brain (Wistar albino)	900 MHz (GSM); SAR, 2.0 W/kg; 2 h/d, 7 d/wk, for 10 mo	Immunocytochemistry: caspase-3, Tp53	No effect on Tp53; caspase-3 re-localized to nucleus	Protein expression scored by visual inspection and evaluation	Dasdag et al. (2009)
Rat brain (Sprague-Dawley)	900 MHz (GSM); SAR, 6 and 1.5 W/kg; exposure 15 min/d for 7 d at high SAR, and 45 min/d for 7 d at low SAR	Cytochrome- <i>c</i> oxidase activity in brain slices by staining with di-amino-benzidine and horse-heart cytochrome- <i>c</i> as substrate	Decreased cytochrome- <i>c</i> oxidase activity in prefrontal, frontal and posterior cortex, septum, and hippocampus, at SAR 6 W/kg	Exposure may affect brain metabolism and neuronal activity	Ammari et al. (2008)
Rat brain (Sprague-Dawley)	900 MHz (GSM); SAR, 6 and 1.5 W/kg; exposure 15 min/d for 8 wk at high SAR, and 45 min/d for 8 wk at low SAR; samples taken 3 and 10 d after exposure	Immunocytochemistry: glial fibrillary acidic protein (Gfap)	Increase in Gfap expression	Gfap increase may be a sign of gliosis	Ammari et al. (2010)
Rat skin (hairless rat, F)	900 MHz or 1800 MHz (GSM); local skin SAR, 5 W/kg; 2 h; sampling immediately after exposure	Immunocytochemistry: Ki67, filaggrin, collagen, elastin	No effect on number of cells expressing Ki-67; no effect on density of filaggrin, collagen and elastin		Masuda et al. (2006)
Rat skin (hairless rat)	900 MHz or 1800 MHz (GSM); local skin SAR, 2.5 and 5 W/kg; 2 h/d, 5 d/wk, for 12 wk; samples taken 72 h after the last exposure	Immunocytochemistry: Ki67, filaggrin, collagen, elastin	No effect on number of cells expressing Ki-67, no effect on density of filaggrin, collagen and elastin		Sanchez et al. (2006a)
Rat skin (hairless rat)	900 MHz or 1800 MHz (GSM); local skin SAR, 5 W/kg; 2 h; sampling immediately after exposure. Multiple exposures to 900 MHz or 1800 MHz (GSM); local skin SAR, 2.5 or 5 W/kg; 2 h/d, 5 d/wk, for 12 wk; samples taken 72 h after the last exposure	Immunocytochemistry: Hsc70, Hsp70 and Hsp25	No effect on expression of stress proteins	Analysis of three areas on three photographs per stained skin slice, quantified by image-analysis software	Sanchez et al. (2008)

Table 4.11 (continued)

Biological model	Exposure conditions	Assessment of protein expression	Results	Comments	Reference
Rat kidney (Wistar; newborn)	9.4 GHz; 5 μ W/cm ² ; 0.5 mW/kg; continuously exposed on days 1–3 or 4–7 after mating	Kidneys from newborns of exposed rats were investigated by means of immunocytochemistry (Bmp4 and Bmp7) and <i>in situ</i> hybridization (receptors Bmpr2 and Bmpr1a)	Significant increase in expression and change in localization of Bmp4. Increase in Bmpr1a, decrease in Bmpr2 expression. Effects were stronger after exposure <i>in utero</i> on days 1–3 of gestation (embryogenesis) than on days 4–7 (organogenesis)	Effects dependent on timing of exposure <i>in utero</i>	Pyrpasopoulou et al. (2004)
Rat thyroid (Wistar)	900 MHz (GSM); SAR, 1.35 W/kg; 20 min/d, 3 wk	Immunocytochemistry, transmission electron microscopy; Casp3 and Casp9 (markers of apoptosis)	Significant increase in expression of Casp3 and Casp9; thyroid hypertrophy; reduced thyroid-hormone secretion; formation of apoptotic bodies	Histomorphometry of thyroid tissue	Eşmekaya et al. (2010)
Rat testis (Sprague-Dawley)	848.5 MHz (CDMA signal); SAR, 2.0 W/kg; 2 \times 45 min/d with a 15-min interval; 12 wk	Western blot; p21, Tp53, Bcl2, Casp3, PARP	No effect for Tp53, Bcl2, Casp3; no result given for PARP or p21		Lee et al. (2010)

2DE, two-dimensional gel electrophoresis; CDMA, code division multiple access; d, day; DTX, discontinuous transmission mode; F, female; GSM, Global System for Mobile Communications; h, hour; M, male; min, minute; mo, month; NS, not specified; SAR, specific absorption rate; wk, week

had risen or declined by 5%, compared with controls. [The genes investigated in this study were not identified, and the changes in gene expression were not validated by RT-PCR.]

Sprague-Dawley rats were exposed to RF radiation at 1.9 GHz (with SARs of 0.9, 1.18, or 1.8 W/kg at a distance of 2.2 cm) from a mobile phone operating in three different modes, for 2 × 3 hours per day, for 18 weeks. A statistically significant upregulation of the mRNAs for calcium ATPase, neural cell-adhesion molecule, neural growth factor, and vascular endothelial growth factor was measured in the brain of these rats. In addition, these mRNAs were upregulated in the mandibular and buccal branches of the facial nerve. These results suggest that neurological damage may be associated with long-term mobile-phone use ([Yan et al., 2008, 2009](#)).

4.3.2 Protein expression

See [Table 4.11](#)

(a) Humans

In a pilot study, a small skin area of one forearm of 10 volunteers was exposed to RF radiation at 900 MHz (GSM; SAR, 1.3 W/kg) for 1 hour. Immediately after exposure, punch biopsies were taken from the exposed area and from the other non-exposed forearm of the same person. Proteins were extracted and analysed by means of 2D-gel electrophoresis. Changes in the expression of eight proteins were found; two of these proteins were observed in all 10 volunteers. Identity and function of these proteins were not given ([Karinen et al., 2008](#)).

(b) Experimental animals

(i) *Drosophila melanogaster*

Exposure of fruit flies (*D. melanogaster*) to RF radiation at 1900 MHz from a mobile phone (GSM; SAR, 1.4 W/kg) for 2 × 1 hour per day, for 10 days, resulted in an increase of 3.6–3.9-fold in the expression of heat-shock protein hsp70,

the phosphorylation of ELK1 kinase, and the DNA-binding activity of the serum-response element (SRE) ([Weisbrot et al., 2003](#)).

As indicated above, exposure of *D. melanogaster* to RF radiation at 835 MHz (GSM; SAR, 1.6 or 4.0 W/kg) for up to 36 hours affected the expression of genes encoding stress-response kinases and proteins involved in the regulation of apoptosis. The expression of the corresponding proteins was confirmed by Western blotting with protein-specific antibodies ([Lee et al., 2008](#)).

[Chavdoula et al. \(2010\)](#) exposed *D. melanogaster* to continuous or intermittent RF radiation at 900 MHz (GSM) from a digital mobile phone (SAR, 0.64 W/kg) for 6 minutes per day, for 6 days. The phone was fully charged and its antenna was in contact with the glass vials containing the flies, and parallel to the vial axis. Exposure to RF radiation caused an increased disorganization of the actin network of the egg chambers. This effect was due to DNA fragmentation, as measured with the TUNEL assay.

(ii) Mouse

Nine studies were performed in mice on changes in protein expression after exposure to RF radiation. The mice were of different age (fetus, or adults aged 6–8 weeks) and different strains (C57BL/6N, C57BL/6NTac, hsp70.1-deficient, BALB/c, ICR); mouse strain and age were not specified in two studies ([Finnie et al., 2009b, 2010](#)). Changes in protein expression were assessed by use of immunocytochemistry with monoclonal and polyclonal antibodies.

ICR mice were exposed to RF radiation at 835 MHz (SAR, 1.6 W/kg and 4.0 W/kg) for 5 hours, 1 hour per day for 5 days, or for 1 month. Changes in the expression of the calcium-binding proteins calbindin D28-k (CB) and calretinin (CR) were measured in the hippocampus by use of immunohistochemistry. Exposure for 1 month produced almost complete loss of pyramidal cells in the CA1 area of the brain. These alterations in calcium-binding proteins may cause

changes in cellular Ca^{2+} levels, which could affect hippocampal functions associated with neuronal connectivity and integration ([Maskey et al., 2010](#)).

Six of the published studies came from a single research group. Most of these studies were based on the same biological material that was separately stained to detect different proteins. Studies from this group have reported no effects on the expression of the following proteins after exposure to RF radiation: c-Fos in adult and fetal mouse brain, stress proteins Hsp25, Hsp32, and Hsp70 in fetal brain, aquaporin 4 in adult brain, and ionized calcium-binding adaptor molecule Iba1 in brain [age not given]. Others have reported similar findings (see [Table 4.11](#)). [The Working Group noted that these studies generally provided very few numerical and technical details.]

(iii) Rat

Eleven studies were performed with rats of different ages (newborn to adult) and different strains (Wistar, Fisher 344, hairless rat, Sprague-Dawley). In addition, different tissues were examined (brain, skin, kidney, testis, thyroid). Detection of changes in protein expression was mostly by immunocytochemistry with protein-specific monoclonal and polyclonal antibodies, and in some studies by Western blotting.

Five studies assessed the effects of exposure to RF radiation in rat brain ([Fritze et al., 1997a](#); [Belyaev et al., 2006](#); [Dasdag et al., 2009](#); [Ammari et al., 2008, 2010](#)). These studies considered a limited number of proteins, generally gave negative results for changes in expression, and provided limited statistical detail. Samples were often analysed visually and without calculating statistical significance. For this reason the results were considered less reliable (see comments in [Table 4.11](#)).

In three studies, the effects of mobile-phone radiation on the skin of hairless rats were investigated ([Masuda et al., 2006](#); [Sanchez et al., 2006a](#),

[2008](#)). No effects were observed on any of the proteins analysed.

[Pyrpasopoulou et al. \(2004\)](#) used immunocytochemistry and hybridization in situ to examine the effects of exposure to RF radiation on kidneys of newborn rats and found that exposure affected the expression of bone morphogenic protein (Bmp4) and bone morphogenic protein receptors (Bmpr2, Bmpr1a). Similar changes were observed in the expression of the corresponding genes, as noted above (Section 4.3.1).

[Eşmekaya et al. \(2010\)](#) observed increased expression and activity of the apoptosis-regulating proteins caspase 3 (Casp3) and caspase 9 (Casp9) by use of light microscopy, electron microscopy, and immunohistochemical methods in the thyroid of Wistar rats exposed to RF radiation at 900 MHz (SAR, 1.35 W/kg) for 20 minutes per day, for 3 weeks.

[Lee et al. \(2010\)](#) examined the effects on rat testis of exposure to RF radiation at 848.5 MHz (SAR, 2.0 W/kg) twice per day for 45 minutes, 5 days per week, for 12 weeks. No significant effects were found on any of the apoptosis-associated proteins tested (p21, Tp53, Bcl2, Casp3, PARP).

[The Working Group noted that only few studies in experimental animals have examined the effects of RF radiation on gene and protein expression. These studies used a variety of biological models, and had mixed and inconsistent results. Many proteins that are known to be important for the initiation and development of cancer in humans were not evaluated. The Working Group concluded that the available studies on gene and protein expression in humans and animals exposed to RF radiation did not provide evidence to support mechanisms of carcinogenesis in humans.]

(c) *In-vitro studies in human cells*

(i) *Heat-shock proteins*

See [Table 4.12](#)

Heat-shock proteins (HSPs) are a highly conserved family of chaperone proteins that are found in all cell types; they are expressed abundantly and have diverse functions. HSPs are expressed in response to cold, heat and other environmental stress factors, although some are expressed constitutively. HSPs increase heat tolerance and perform functions essential to cell survival under these conditions. Some HSPs serve to stabilize proteins in specific configurations, while others play a role in the folding and unfolding of proteins, acting as molecular chaperones. Stress-induced transcription of HSPs requires activation of heat-shock factors that bind to the heat-shock promoter element, thereby activating its transcription activity. Overexpression of HSPs has been linked to oncogenic development and poor prognostic outcome for multiple cancers, possibly through the roles of HSPs as mediators of signal transduction and inhibitors of oncogene-mediated senescence ([Evans et al., 2010](#)). Since markedly increased expression of HSPs is co-incident with exposure of cells to a variety of stress factors, expression of HSP genes and proteins in response to exposure to RF radiation has been extensively investigated in a variety of cell models.

Since the effects of RF radiation on HSP expression have been reviewed previously ([Cotgreave, 2005](#)), only recent publications on this issue are reviewed in detail in this Volume. Several studies have reported changes in HSP expression in human cell lines exposed to RF radiation.

[Tian et al. \(2002\)](#) exposed human glioma (MO54) cells to RF radiation at 2.45 MHz (SAR, 5–100 W/kg) for up to 16 hours. An increase in HSP70 protein levels at SARs of 25 and 78 W/kg was observed, but no effect was seen at SARs below 20 W/kg. [The Working Group noted that thermal confounding cannot be ruled out in this study due to the high relative SARs tested, the highly non-uniform SAR distribution within the exposure system, and the considerable reduction

in cell viability (~70%) in some samples during exposure.]

[Leszczynski et al. \(2002\)](#) exposed a human endothelial cell line (EA.hy926) to RF radiation at 900 MHz (GSM; SAR, 2 W/kg) for 1 hour. The phosphorylation status of several proteins was altered. Specifically, HSP27 was found to undergo a transient increase in expression and phosphorylation immediately after exposure, but this effect had disappeared at 1 or 4 hours after exposure.

[Lim et al. \(2005\)](#) exposed human peripheral blood cells to RF radiation at 900 MHz (average SAR, 0.4, 2.0 or 3.6 W/kg) for 20 minutes, 1 hour, or 4 hours. No statistically significant differences were detected in the number of lymphocytes or monocytes expressing stress proteins HSP27 or HSP70 after exposure, compared with the numbers in sham-exposed samples.

[Miyakoshi et al. \(2005\)](#) exposed human malignant glioma MO54 cells to RF radiation at 1950 MHz (SAR, 1, 2, or 10 W/kg) for up to 2 hours. Exposed cells did not show increased expression of HSP27 or HSP70 protein, but levels of phosphorylated HSP27 had decreased significantly in cells exposed at a SAR of 10 W/kg for 1 or 2 hours.

The transcription of HSPs is regulated by the DNA-binding activity of heat-shock transcription factors (HSFs). These factors bind to specific regulatory elements in the promoter region of HSP genes. In a study by [Laszlo et al. \(2005\)](#), no DNA-binding activity of HSF protein was detected in hamster (HA-1), mouse (C3H 10T $\frac{1}{2}$) and human cells (HeLa S3) exposed to 835.62 MHz (SAR, ~0.6 W/kg) or 847.74 MHz (SAR, ~5 W/kg) RF radiation, for up to 24 hours.

[Lee et al. \(2006\)](#) observed no detectable alterations in the expression of HSP27, HSP70 or HSP90 transcripts after exposure of human T-lymphocyte Jurkat cells to RF radiation at 1763 MHz (SAR, 2 or 20 W/kg) for 30 minutes or 1 hour.

Table 4.12 Effects on heat-shock proteins in human cell lines exposed to radiofrequency radiation *in vitro*

Tissue/cell line	Exposure conditions	End-point and target	Results	Comments	Reference
MO54 glioma cells	2450 MHz, CW; SARs, 5, 20, 50, 100 W/kg; 2, 4, 8, 16 h	HSP70 protein expression	Increased expression of HSP70 only at SARs > 20 W/kg	SAR values very high; thermal confounding possible	Tian et al. (2002)
EA.hy926 endothelial cells	900 MHz (GSM); SAR, ~2 W/kg; 1 h	p-HSP27 protein level	Transient change in p-HSP27 and phosphorylation of other unidentified proteins; transient change in HSP27 protein level	Effect had disappeared at 1 or 4 hours after exposure	Leszczynski et al. (2002)
EA.hy926 endothelial cells	1800 MHz (GSM); SAR, 2.0 W/kg; 1 h	Protein HSP27 expression	No effect		Nylund et al. (2009)
Human lens epithelial cells (hLEC)	1800 MHz (GSM); SAR, 1, 2, 3 W/kg; 2 h	HSP70 mRNA and protein expression	Increased expression of HSP70 protein at SAR 2 and 3 W/kg; no change in mRNA levels		Lixia et al. (2006)
HeLa, S3 and EA.hy296 cell lines	837 MHz (TDMA); SAR, 5 W/kg; 1, 2, 24 h; or 900 MHz (GSM); SAR, 3.7 W/kg; for 1, 2, 5 h	p-HSP27 protein levels	No effect		Vanderwaal et al. (2006)
A172 cells and IMR-90 fibroblasts	2142.5 MHz (CW or W-CDMA); SAR, 0.08 and 0.8 W/kg; 2–48 h	HSP27, HSP40, HSP70, HSP105 mRNA and protein expression, p-HSP27 protein levels	No effect		Hirose et al. (2007)
Human blood	900 MHz (CW or GSM); SAR, 0.4, 2 or 3.6 W/kg; 20 min, 1 h, or 4 h	HSP27, HSP70 protein expression	No effect		Lim et al. (2005)
A172 cells	2450 MHz (CW); SAR, 5–200 W/kg; 1–3 h	HSP27, HSP70 protein expression; p-HSP27 protein levels	No effect	SAR values very high (thermal confounding possible)	Wang et al. (2006)
MO54 cells	1950 MHz (CW); SARs, 1, 2, 10 W/kg; 1 or 2 h	HSP27, HSP70 protein expression; p-HSP27 protein levels	Decrease in p-HSP27 at highest SAR		Miyakoshi et al. (2005)
Mono Mac 6 cells	1800 MHz (CW and GSM); SAR, 2 W/kg; 1 h	HSP70 protein expression	No effect		Simkó et al. (2006)
Mono Mac 6 and K562 cells	1800 MHz (CW and GSM); SARs, 0.5, 1, 1.5, or 2 W/kg; 45 min	HSP70 protein expression	No effect		Lantow et al. (2006a)
U-251MG cells	6000 MHz (CW); power density 5.4 µW/cm ² or 0.54 mW/cm ² ; 1–33 h	HSP70 mRNA and protein	No effect		Zhadobov et al. (2007)

Table 4.12 (continued)

Tissue/cell line	Exposure conditions	End-point and target	Results	Comments	Reference
HTR-8/ neo; human trophoblast cell line	1817 MHz (GSM); SAR, 2.0 W/kg; 1 h	HSP70, HSC70 mRNA expression	No effect		Valbonesi et al. (2008)
Human keratinocytes, fibroblasts and reconstructed epidermis	900 MHz (GSM); SAR, 2 W/kg; 48 h	HSP27, HSC70, and HSP70 protein expression	Keratinocytes: no effect Epidermis: slight but significant increase in HSP70 Fibroblasts: significant decrease in HSC70		Sanchez et al. (2006b)
Human primary keratinocytes and fibroblasts	1800 MHz (GSM); SAR, 2 W/kg; 48 h	HSP27, HSP70 and HSC70 protein expression	No effect		Sanchez et al. (2007)
HeLa S3, HA-1, C3H 10T½	835 MHz (FDMA) and 847 MHz (CDMA); SAR, 0.6 W/kg (low dose) and 5 W/kg (high dose); 5–60 min, 24 h	HSF protein DNA- binding activity	No effect		Laszlo et al. (2005)
Jurkat cells	1763 MHz (CDMA), SAR, 2 or 20 W/kg; 30 min or 1 h	HSP27, HSP70, HSP90 protein expression	No effect		Lee et al. (2006)
MO54, A172 and T98 cell lines	1950 MHz (CW); SAR, 1 or 10 W/kg; 1 h	HSP27 mRNA and protein expression, p-HSP27 protein levels	No effect on HSP27 expression Slight decrease in p-HSP27 levels in MO54 cells		Ding et al. (2009)
TK6 cells	1900 MHz (pulsed-wave; 5 min on, 10 min off); SAR, 1 and 10 W/kg; 6 h	HSP27, HSP70 mRNA expression	No effect		Chauhan et al. (2006a)
HL60 and Mono Mac 6 cells	1900 MHz (pulse-wave; 5 min on, 10 min off); SAR, 1 and 10 W/kg; 6 h	HSP27, HSP70 mRNA expression	No effect		Chauhan et al. (2006b)
Mono Mac 6 and U87MG cells	1900 MHz (pulsed-wave; 5 min on, 10 min off); SAR, 0.1, 1 and 10 W/kg; 6–24 h	HSP27, HSP40, HSP70, HSP90, HSP105 mRNA expression	No effect		Chauhan et al. (2007a)
U87MG cells	1900 MHz; SAR, 0.1, 1, 10 W/kg; 4 h	HSP27, HSP40, HSP70, HSP86, HSP105 mRNA expression	No effect		Qutob et al. (2006)

CDMA, code-division multiple access; CW, continuous wave; FDMA, frequency-domain multiple access; GSM, Global System for Mobile Communications; h, hour; HSC, heat-shock cognate; HSF, heat-shock factor; HSP, heat-shock protein; p-HSP27, phosphorylated-HSP27; min, minute; RF, radiofrequency; SAR, specific absorption rate; SRE, serum-response element; TDMA, time-domain multiple access; WCDMA, wideband code-division multiple access

[Lixia et al. \(2006\)](#) exposed human lens epithelial cells to RF radiation at 1800 MHz (GSM; SAR, 1, 2, or 3 W/kg) for 2 hours. The authors noted increased expression of HSP70 protein at the higher SARs, but no corresponding change was observed in mRNA expression.

[Simkó et al. \(2006\)](#) exposed a human monocyte-derived cell line (Mono-Mac-6) to RF radiation at 1800 MHz (SAR, 2 W/kg) for 1 hour, either alone or with ultra-fine particles. The authors observed no effect on the expression of HSP70 protein. In a follow-up study, [Lantow et al. \(2006a\)](#) investigated whether exposure to RF radiation at 1800 MHz (SAR, 0.5–2.0 W/kg) for 45 minutes had an effect on expression of HSP70 in Mono-Mac-6 and K562 cells. No significant effects of exposure to RF radiation were detected in the expression of HSP70 protein in either cell line under any of the conditions tested.

[Vanderwaal et al. \(2006\)](#) found no evidence of altered HSP27 phosphorylation in three human cell lines (HeLa, S3 and EA.hy296) after exposure to RF radiation at 837 MHz (SAR, 5.0 W/kg) for 1, 2, or 24 hours, or at 900 MHz (SAR, 3.7 W/kg) for 1, 2 or 5 hours.

[Wang et al. \(2006\)](#) did not detect any alterations in HSP27, HSP70 or expression of phosphorylated-HSP27 protein in human A172 cells – derived from a malignant glioblastoma – exposed to RF radiation at 2450 MHz (SARs of up to 50 W/kg) for 0–3 hours.

[Sanchez et al. \(2006b\)](#) evaluated possible stress-related effects in isolated human skin cells and in reconstructed human epidermis exposed to RF radiation at 900 MHz (SAR, 2 W/kg) for 48 hours. Immunohistochemical analysis did not reveal any detectable changes in expression of HSP27 or inducible HSP70 in exposed keratinocytes. However, levels of HSC70 (heat shock cognate) protein were significantly decreased in dermal fibroblasts isolated from human skin after exposure to RF radiation. Such results were not seen in reconstructed human epidermis. Human skin cells may thus react to exposure by

modulating the expression of some HSPs, but this response may depend on the cell model. In a follow-up study, the same investigators found that primary human skin cells (keratinocytes and fibroblasts) did not display any alterations in inducible HSP27, HSP70 or HSC70 protein levels after exposure at 1800 MHz (SAR, 2 W/kg) for 48 hours ([Sanchez et al., 2007](#)). [The authors did not discuss the different responses observed in these two studies.]

[Hirose et al. \(2007\)](#) examined HSP27 phosphorylation, gene and protein expression in human glioblastoma A172 cells and human IMR-90 fetal lung fibroblasts exposed to RF radiation at 2142.5 MHz (SARs up to 0.8 W/kg) for 2–48 hours. No evidence of altered HSP27 phosphorylation or increased mRNA expression of a variety of HSPs was found in either cell line.

[Zhadobov et al. \(2007\)](#) investigated the expression of stress-sensitive genes and proteins in a human glial cell line (U-251MG) exposed to RF radiation at 60 GHz (power density, 5.4 $\mu\text{W}/\text{cm}^2$ or 0.54 mW/cm^2) for 1–33 hours. No evidence was found for altered expression of stress-response genes, as determined by reporter assays and RT-PCR. Western-blot analysis indicated no effects of RF radiation on levels of clusterin or HSP70 protein.

[Valbonesi et al. \(2008\)](#) observed no change in expression of HSP70 in the human HTR-8/SVneo trophoblast cell-line exposed to RF radiation at 1800 MHz (SAR, 2 W/kg) for 1 hour.

Exposure of the human endothelial cell line EA.hy926 to 1.8 GHz RF radiation (SAR, 2.0 W/kg) for 1 hour did not result in altered HSP protein expression; phosphorylation status was not assessed in this study ([Nylund et al., 2009](#)).

[Ding et al. \(2009\)](#) studied three human glioma cell-lines (MO54, A172, T98) and found no evidence of altered HSP expression or phosphorylation after exposure to RF radiation at 1950 MHz (SAR, 1 or 10 W/kg) for 1 hour. These findings were supported by results of a series of earlier studies by [Chauhan et al. \(2006a, b, 2007a\)](#)

and [Qutob et al. \(2006\)](#), in which exposure at 1900 MHz (SAR, 0.1–10 W/kg) for 4–24 hours did not alter the transcript expression of HSP27, HSP40, HSP70, HSP90 or HSP105, in several human cell lines (MM6, U87MG, HL60, TK6).

[The Working Group noted that a small number of studies reported altered expression of HSPs in certain cell lines ([Leszczynski et al., 2002](#); [Tian et al., 2002](#); [Miyakoshi et al., 2005](#); [Lixia et al., 2006](#); [Sanchez et al., 2006b](#)). However, it was not clear whether these responses were specific to the cell line, the frequency, the modulation or model used, or were false-positives, e.g. artefacts caused by irregularities in the exposure system. The majority of studies conducted in cultured human cells to date have found no evidence that exposure to RF radiation under non-thermal conditions elicits alterations in the expression of HSP genes or proteins.]

(ii) *Proto-oncogenes and signal-transduction pathways*

See [Table 4.13](#)

Several studies have investigated the ability of RF radiation to mediate the expression of proto-oncogenes and proteins involved in the regulation of signal-transduction pathways. Proto-oncogenes are genes with the capacity to induce cellular proliferation and/or transformation. While these genes are constitutively expressed at low levels, they are rapidly and transiently induced in response to external stress stimuli. Similarly, transcriptional activity in response to stress factors can be mediated by mitogen-activated protein kinase (MAPK) pathways, which include the extracellular signal-regulated kinase (ERK), p38 and the c-Jun N-terminal kinase (JNK) cascades. These pathways are complex and regulate a variety of cellular processes, including proliferation, differentiation, metabolism and the stress response. Upon phosphorylation of these kinases, a large number of regulatory proteins and transcription factors can become activated, thereby altering

cellular processes and allowing further gene transcription.

[Li et al. \(1999\)](#) exposed human fibroblasts to continuous-wave RF radiation at 837 MHz (SAR, 0.9–9.0 W/kg) for 2 hours. No evidence of altered expression of TP53 protein was found.

[Leszczynski et al. \(2002\)](#) exposed a human endothelial cell line (EA.hy926) to RF radiation at 900 MHz (SAR, 2 W/kg) for 1 hour. A transient increase was noted in p38-MAPK and in phosphorylation of HSP27. This effect could be inhibited by SB203580 (a specific inhibitor of p38-MAPK). Since accurate measurements indicated no alterations in cell-culture temperature during the exposure period, activation of the p38-MAPK stress-response pathway might be a potential mode of non-thermal molecular interaction of RF radiation with biological tissue.

[Caraglia et al. \(2005\)](#) exposed human epidermoid-cancer KB cells to RF radiation at 1950 MHz (SAR, 3.6 W/kg) for 1–3 hours. Decreased expression was noted for the proteins Ras, Raf-1 and Akt. The activity of Ras and ERK1/2 was determined by their phosphorylation status, and found to be reduced. This exposure to RF radiation increased JNK1/2 activity and expression of HSP27 and HSP70, but caused a reduction in p38-MAPK activity and HSP90 expression. [The Working Group noted that details on the exposure system were incompletely described, and that these observations may have been due to thermal effects.]

[Miyakoshi et al. \(2005\)](#) exposed human glioma cells (MO54) to RF radiation at 1950 MHz (SAR, 10 W/kg) for 2 hours. A decrease was noted in the phosphorylation of HSP27 at serine-78, indicating repression of the p38-MAPK cascade or activation of an HSP27 phosphatase.

[Lee et al. \(2006\)](#) exposed Jurkat cells to RF radiation at 1763 MHz (SAR, 2 or 20 W/kg) for 30 minutes to 1 hour in the presence or absence of the phorbol-ester, 12-O-tetradecanoylphorbol-13-acetate (TPA). There was no evidence of an altered phosphorylation status of ERK1/2,

Table 4.13 Studies on the effect of radiofrequency radiation on the expression of proto-oncogenes in human cells *in vitro*

Tissue/cell line	Exposure	End-point and target	Results	Comments	Reference
Human endothelial EA.hy926 cells	900 MHz (GSM); ~2 W/kg; 1 h	p38MAPK protein expression	Transient change		Leszczynski et al. (2002)
Rat1, HeLa cells	800/875/950 MHz; power density 0.07–0.31 mW/cm ² ; 5–30 min	ERK1/2, JNK1/2, p38MAPK, EGFR, Hb-EGF protein expression, phosphorylation status	Transient increase of ERK1/2 phosphorylation at 0.10 mW/cm ² . Phosphorylation of p38MAPK and JNK1/2 (stress-activated cascades) is not changed. Phosphorylation is ROS-dependent	Stress-activated cascades are not affected, which may indicate that effects are non-thermal. Temperature remained constant within 0.05 °C.	Friedman et al. (2007)
Human epidermoid KB cell line	1950 MHz; SAR, 3.6 W/kg; 1, 2, 3 h	Ras, Raf-1, Akt, ERK1/2, JNK1/2, HSP27, HSP70, HSP90 protein expression, phosphorylation status	Expression of ras, Raf-1, Akt, and HSP90 was reduced; expression of HSP27 and HSP70 was increased. Phosphorylation of ERK1/2, ras, p38MAPK was reduced, while that of JNK1/2 was increased	Incomplete details on RF exposure; no temperature control; possible thermal confounding	Caraglia et al. (2005)
Human neuroblastoma (SH-SY5Y) cells	900 MHz (GSM); SAR, 1 W/kg; 5, 15, 30 min, 6 h, 24 h	EGR1, ERK1/2, SAPK/JNK, p38MAPK, ELK1, BCL2, survivin mRNA and protein expression, phosphorylation status	Transient increase in EGR1 and ELK1 transcript levels; transient increase in ERK1/2, SAPK/JNK phosphorylation. Evidence of apoptosis after 24 h exposure	Confounding due to environmental factors unclear	Buttiglione et al. (2007)
Jurkat cells	1763 MHz (CDMA); SAR, 2 or 20 W/kg; 30 min or 1 h	p38MAPK, ERK1/2, JNK1/2 protein expression, phosphorylation status	No effect on protein expression for HSP90, HSP70, HSP27; no effect on phosphorylation with/without TPA	Exposure conditions and temperature properly controlled	Lee et al. (2006)
Human glioma MO54 cells	1950 MHz (CW); SAR, 10 W/kg; 1h and 2h	Phosphorylated HSP27 protein levels	Decrease in phosphorylation of HSP27		Miyakoshi et al. (2005)
TK6, MM6, HL-60 cells	1900 MHz (PW; 5 min on, 5 min off); SAR, 1 or 10 W/kg; 6 h	c-fos, c-myc, c-jun mRNA expression	No effect		Chauhan et al. (2006a, b)
WS1neo human foreskin fibroblasts	837 MHz (CW); SAR, 0.9 or 9 W/kg; 2 h	TP53 protein expression	No effect		Li et al. (1999)
Human glioblastoma A172, human lung IMR-90 fibroblasts	2142.5 MHz (CW, W-CDMA); SAR, 80, 250, 800 mW/kg; 24, 28, 48 h	APAF1, TP53, TP53BP2 and CASP9 protein levels, phosphorylation status	No effect	Temperature control unclear	Hirose et al. (2006)

CDMA, code-division multiple access; CW, continuous-wave; FDMA, frequency-division multiple access; FMCW, frequency-modulated continuous wave; GSM, Global System for Mobile communications; h, hour; min, minute; RF, radiofrequency; SAR, specific absorption rate; TDMA, time-division multiple access; TPA, 12-*O*-tetradecanoylphorbol-13-acetate; W-CDMA, wideband code-division multiple access

JNK1/2 or p38-MAPK after exposure to RF radiation, with or without TPA.

[Chauhan et al. \(2006a, b\)](#) exposed three human-derived cell lines (TK6, MM6, HL-60) to intermittent (5 minutes on/10 minutes off) RF radiation at 1900 MHz (SAR, 1 or 10 W/kg) for 6–24 hours. No significant differences were observed in relative expression levels of the proto-oncogenes *c-JUN*, *c-FOS* and *c-MYC* in any of the cell lines examined.

[Hirose et al. \(2006\)](#) examined gene-transcript levels in human A172 and IMR-90 cells following exposure to RF radiation. A series of genes known to be involved in TP53-mediated apoptosis (including *APAF1*, *TP53*, *TP53BP2* and *CASP9*) were assessed after the cells had been exposed at 2142.5 MHz (SAR, 0.08–0.8 mW/kg) for up to 48 hours. No significant differences were observed in the expression of these TP53-related apoptosis genes, relative to the sham-exposed control groups, under any of the conditions tested.

[Buttiglione et al. \(2007\)](#) assessed the expression levels of several transcription factors (EGR1, BCL2, ELK1) downstream of the MAPK pathways. EGR1 transcript expression and phosphorylation of ERK1/2 and JNK in human SH-SY5Y neuroblastoma cells were evaluated after exposure to 900 MHz RF radiation (SAR, 1 W/kg) for 5 minutes up to 24 hours. There was a transient increase in EGR1 levels at 5–30 minutes after exposure; this effect was no longer evident at 6–24 hours after exposure. Phosphorylation of ERK1/2, JNK1/2 and ELK1 was also transiently increased after various exposure times (5 minutes to 6 hours), while a significant decrease in the transcript levels of BCL2 and survivin was observed after 24 hours of exposure. However, a significant decrease in cell viability (as determined by the MTT assay) was noted, as well as the appearance of subG₁ nuclei and a G₂-M block (as determined by flow cytometry) after 24 hours of exposure. [The Working Group noted that the appearance of subG₁ nuclei is indicative of possible induction of apoptosis in the cell

culture. It was unclear whether this effect was thermal or non-thermal in nature.]

[Friedman et al. \(2007\)](#) reported that low-level exposure of serum-starved HeLa cells to RF radiation at 875–950 MHz (power densities, 0.07–0.31 mW/cm²) for 5–30 minutes, significantly activated the ERK1/2 signal-transduction pathway via generation of ROS through NADPH-oxidase activation. Neither the p38-MAPK nor the JNK1/2 stress-response pathways were activated by RF radiation. [The Working Group noted that the description of the exposure conditions in this study was poor.]

[The Working Group noted that there was weak evidence from studies with human cell lines that non-thermal RF exposure could result in alterations in the expression or phosphorylation of proto-oncogenes or proteins involved in signal-transduction pathways. Most studies that report altered expression of genes or proteins, or phosphorylation of proteins involved in cell homeostasis, proliferation and signal-transduction pathways, appeared to have been conducted under unique exposure conditions, with results that show no clear dose- and time-response.]

(d) *High-throughput studies of gene and protein expression*

See [Table 4.14](#)

In recent years, many studies have employed high-throughput techniques to analyse differential gene/protein expression in human cells in response to exposure to RF (reviewed by [Vanderstraeten & Verschaeve, 2008](#); [McNamee & Chauhan, 2009](#)). While such technology offers ample opportunity for understanding potential biological interactions of RF radiation in a hypothesis-free testing approach, it is also subject to generating a large number of “false-positive” results. For this reason, it is fundamentally important that such high-throughput studies employ rigorous statistical-inference analysis, include an appropriate number of biological replicates, and validate the differential expression of gene

Table 4.14 High-throughput studies on the effects of radiofrequency radiation on gene and protein expression

Tissue/cell line	Exposure	Platform	Results	Comments	Reference
C3H 10T½ mouse cells	847.7 MHz (CDMA) or 835.6 MHz (FDMA); SAR, 5 W/kg; 24 h	Affymetrix GeneChip U74Av2	Differential expression of ~200 genes	Not confirmed by RT-PCR	Whitehead et al. (2006)
Mouse embryo primary cultured neurons/astrocytes	1900 MHz (GSM); SAR not reported; 2 h	GEArray Q Series Mouse Apoptosis gene array, RT-PCR	Neurons: upregulation of <i>Casp2</i> , <i>Casp6</i> , <i>Pycard</i> ; <i>Casp9</i> and <i>Bax</i> mRNA levels unchanged Astrocytes: upregulation of <i>Casp2</i> , <i>Casp6</i> , <i>Pycard</i> , <i>Bax</i>	Uncontrolled experimental conditions (exposure from mobile phone). Confirmed by RT-PCR	Zhao et al. (2007a)
Rat neurons	1800 MHz (GSM PW; 5 min on, 10 min off); SAR, 2 W/kg; 24 h	Affymetrix GeneChip Rat Neurobiology U34 Array	Of 1200 screened genes, 24 were upregulated and 10 were downregulated	Confirmed by RT-PCR; fair agreement with microarray data	Zhao et al. (2007b)
EA.hy926 human endothelial cells	900 MHz (GSM); SAR, 2.4 W/kg; 1 h	2DE protein analysis (silver staining), MALDI-MS	Found 38 altered spots; 4 spots identified by MALDI-MS: 2 spots (increased expression) were identified as vimentin isoforms (confirmed by Western blot) 2 spots (downregulated expression) were identified as IDH3A and HNRNPH1		Nylund & Leszczynski (2004)
EA.hy926, EA.hy926v1,	900 MHz (GSM); SAR, 2.8 W/kg; 1 h	Atlas Human v1.2 cDNA arrays (1167 genes screened); 2DE protein analysis (silver staining)	EA.hy926 cells: 1 gene downregulated, 38 altered protein spots in EA.hy926 EA.hy926v1 cells: 13 genes upregulated, 45 altered protein spots	No confirmation of gene-expression results with RT-PCR, or of proteome results with Western blotting; minimum number of biological replicates	Nylund & Leszczynski (2006)
MCF7 cells	849 MHz (CDMA); SAR, 2 or 10 W/kg; 1 h/d for 3 d	2DE protein analysis (silver staining), electrospray ionization MS-MS, Western blotting, RT-PCR	No reproducible changes in protein expression; GRP78 protein/RNA not differentially expressed	Exposure conditions and temperature properly controlled. Minimum number of biological replicates	Kim et al. (2010)
Human lens epithelial cells (hLEC)	1800 MHz (GSM); SAR, 1, 2, 3.5 W/kg; 2 h	2-DE protein analysis (silver staining), electrospray ionization MS-MS	More than 1600 protein spots were differentially expressed in each condition vs sham-exposed control. Of four upregulated proteins (at SAR 2 and 3.5 W/kg), two were identified by MS (hnRNP K, HSP70)	Number of independent experiments unclear; no confirmation by Western blotting	Li et al. (2007)

Table 4.14 (continued)

Tissue/cell line	Exposure	Platform	Results	Comments	Reference
Jurkat cells, fibroblasts, leukocytes	1800 MHz (GSM PW, 5 min on, 10 min off); SAR, 2 W/kg; 8 h	2DE protein analysis (fluorescence), ion-trap MS-MS	No differentially expressed protein spots by fluorescence 2DE. Increased rate (> 2-fold) of <i>de novo</i> protein synthesis in exposed cells	Not corrected for multiple comparisons; no confirmation by Western blotting; minimum number of biological replicates	Gerner et al. (2010)
NB69, U937 EA.hy926, CHME5, HL60, lymphocytes, used pooled RNA	900 or 1800 MHz (GSM); SAR, 0.77 or 1.8–2.5 W/kg; 1, 24, and 44 h	Human Unigene RZPD-2 cDNA array (~75 000 probes screened)	Differential gene expression in three cell lines (EA.hy926, U937, HL60)	No confirmation of results with RT-PCR; insufficient number of biological replicates. Exposure conditions and temperature properly controlled	Remondini et al. (2006)
Jurkat cells	1763 MHz (CDMA); SAR, 10 W/kg; 1 h/d for 3 d	Applied Biosystems 1700 full genome array (30000 probes)	No gene-expression changes > 2-fold; 10 genes changed > 1.3-fold ($P < 0.1$)	No confirmation of results with RT-PCR	Huang et al. (2008a)
A172, H4 and IMR90 cell lines	2142.5 MHz (CW and W-CDMA); SAR, 0.08, 0.25, 0.80 W/kg; 96 h	Affymetrix Human Genome HG-U133A and B arrays	Differential expression (>2-fold) of 8 genes (H4 cells), 5 genes (A172 cells) and 1 gene (IMR90 cells)	Genes not all identified; insufficient number of independent experiments; no confirmation by RT-PCR	Sekijima et al. (2010)
MCF7 cells	1800 MHz (GSM PW; 5 min on, 10 min off); SAR, 2 or 3.5 W/kg; 24 h	Affymetrix GeneChip Test3 arrays (~22 000 probes screened)	No effect at 2 W/kg; five genes upregulated at 3.5 W/kg	RT-PCR analysis did not confirm differential expression of the five candidate genes identified by microarray analysis. Insufficient number of biological replicates	Zeng et al. (2006)
A172 and IMR90 cells	2142.5 MHz (CW and W-CDMA); SAR, 0.08, 0.25, 0.8 W/kg; 24, 28, 48 h	Affymetrix Human Genome U133 Plus 2.0 GeneChip (38 000 probes screened)	No consistent changes in gene expression in two experiments. Lack of response for TP53-related gene expression (<i>TP53</i> , <i>TP53BP2</i> , <i>APAF1</i> and <i>CASP9</i>) confirmed by microarray hybridization and RT-PCR	Insufficient number of biological experiments	Hirose et al. (2006)
A172 cells and IMR90 fibroblasts	2142.5 MHz (CW and W-CDMA); SAR, 0.08 or 0.8 W/kg; 2–48 h	Affymetrix Human Genome U133 Plus 2.0 GeneChip (38 000 probes screened)	No effect	No parallel experiments with RT-PCR; insufficient number of biological replicates	Hirose et al. (2007)

Table 4.14 (continued)

Tissue/cell line	Exposure	Platform	Results	Comments	Reference
U87MG glioblastoma cells	1900 MHz (PW); SAR 0.1, 1, 10 W/kg; 4 h	Agilent Human 1A arrays (~22 000 probes screened)	No effect	Lack of effect on several HSPs confirmed by RT-PCR; multiple doses of RF radiation tested; concurrent positive, negative and sham controls; exposure conditions and temperature properly controlled	Outob <i>et al.</i> (2006)
TK6, HL60, Mono Mac 6 cells	1900 MHz (pulsed-wave; 5 min on, 10 min off); SAR, 0.1, 1, 10 W/kg; 6 or 24 h	Agilent Human 1Av2 arrays (~22 000 probes screened)	No effect	No parallel experiments with RT-PCR; multiple doses of RF radiation tested; concurrent positive, negative and sham controls; exposure conditions and temperature properly controlled	Chauhan <i>et al.</i> (2007a)
Glial cell line (SVGp12)	2450 MHz (CW); SAR, 1, 5, 10 W/kg; 1, 2, 24 h	AceGene Premium Human DNA Array, RT-PCR	Microarray analysis identified 23 differentially expressed genes and showed 5 unassigned gene spots: 17 genes were upregulated, 11 were downregulated	RT-PCR analysis with 22 of the 23 genes did not confirm microarray data. Minimum number of biological replicates	Sakurai <i>et al.</i> (2011)
EA.hy926 cells	1800 MHz (GSM); SAR, 2 W/kg; 1 h	2DE protein analysis, MALDI-TOF MS analysis, Western blotting	Eight differentially expressed protein spots; three identified as SRM, GRP78 and PSA1	Western blot found no response in GRP78, or changes in HSP27 and vimentin expression	Nylund <i>et al.</i> (2009)
HUVEC, HBMEC cells	1800 MHz (GSM); SAR, 2 W/kg; 1 h	2DE-DIGE	No differentially expressed spots in either cell line when corrected for multiple comparisons (correction for false-discovery rate)	Exposure conditions and temperature properly controlled	Nylund <i>et al.</i> (2010)

2DE, two-dimensional gel electrophoresis; CDMA, code-domain multiple access; CW, continuous wave; d, day; DIGE, difference gel electrophoresis; FDMA, frequency domain multiple access; GSM, Global System for Mobile Communications; h, hour; HSC, heat-shock cognate; HSF, heat-shock factor; HSP, heat-shock protein; min, minute; MALDI-MS, matrix-assisted laser desorption/ionization mass spectrometry; MALDI-TOF MS, matrix-assisted laser desorption/ionization-time of flight mass spectrometry; MS-MS, tandem mass spectrometry; p-HSP27, phosphorylated-HSP27; PW, pulsed wave; RT-PCR, reverse-transcriptase polymerase chain reaction; SAR, specific absorption rate; SRE, serum response element; W-CDMA, wideband-code division multiple access

and proteins by use of alternative techniques (e.g. RT-PCR or Western blotting).

(i) *Proteomics studies in human cells*

[Nylund & Leszczynski \(2004\)](#) reported altered expression of 38 protein spots – observed in a two-dimensional (2D) electrophoresis gel – and identified 4 proteins by matrix-assisted laser desorption/ionization–mass spectrometry (MALDI-MS) in the human endothelial cell line EA.hy926, exposed to RF radiation at 900 MHz (SAR, 2.4 W/kg) for 1 hour. Of particular interest was that two of the spots identified were isoforms of the cytoskeletal protein, vimentin. In a subsequent genomics/proteomics study, [Nylund & Leszczynski \(2006\)](#) observed that 1 gene was downregulated in the EA.hy926 cell line and 13 genes were upregulated in a related EA.hy926v1 cell line exposed to RF radiation at 900 MHz (SAR, 2.8 W/kg) for 1 hour. Proteome analysis indicated 38 differentially expressed proteins in the EA.hy926 cell line and 45 altered proteins in the EA.hy926v1 cell line. The identity of the differentially expressed proteins was not determined. More recent studies by these authors, with exposure of the cells at 1800 MHz (SAR, 2.0 W/kg) did not show the altered expression of, e.g. vimentin ([Nylund et al., 2009, 2010](#)). [The Working Group noted that the observations reported in these studies were either not confirmed by Western blotting, or were identified as artefacts upon further investigation. The discrepancy in the results with RF radiation at 900 and 1800 MHz may be attributable to the different exposure frequencies; the different distribution of SAR within the cell cultures, *i.e.* less uniform SAR distribution at 900 MHz; and the occurrence of false positives when using the silver-stain-based 2D gel-electrophoresis technique.]

[Li et al. \(2007\)](#) exposed human lens epithelial cells to RF radiation at 1800 MHz (SAR, 1, 2, and 3.5 W/Kg) for 2 hours. In the 2D-electrophoresis pattern, enhanced expression was noted of two stress-related proteins, namely HSP70 and

ribonucleoprotein K. [The Working Group noted that failure to confirm the identity of the spots by Western blotting made the results of this study difficult to interpret.]

[Kim et al. \(2010\)](#) employed 2D gel-electrophoresis to examine the proteome of human MCF7 breast-cancer cells exposed to RF radiation at 849 MHz (SAR, 2 or 10 W/kg) for 1 hour per day, on three consecutive days. At 24 hours after exposure, no significant differences in protein expression were identified between exposed and sham-exposed cells.

[Gerner et al. \(2010\)](#) assessed relative protein expression in Jurkat cells, human fibroblasts and primary mononuclear cells (leukocytes) exposed to intermittent (5 minutes on, 10 minutes off) RF radiation at 1800 MHz (SAR, 2 W/kg during the “on” phase) for 8 hours, in growth medium containing [³⁵S]methionine/cysteine. No significant differences were observed between sham-exposed and RF-exposed samples in the expression of any particular proteins by use of 2D gel-electrophoresis with fluorescence detection. However, cells exposed to RF radiation for 8 hours displayed a significant increase in protein synthesis, measured as enhanced incorporation of ³⁵S in autoradiographs of the 2D gel: in Jurkat cells, 14 proteins showed a doubling of the spot intensity in the autoradiograph. All these proteins were identified by ion-trap mass spectrometry. Of these 14 proteins, 13 were also enhanced in 2D autoradiographs prepared with samples from exposed fibroblasts. Several stress-responsive proteins were particularly affected, including Hsp70 and Hsp90. The enhancement of the signals in the leukocytes (stimulated/non-stimulated) were much weaker, with only heat-shock protein Hsp60 showing a more than twofold increase. These results suggest increased synthesis *de novo* of these proteins in cells exposed to RF radiation. None of these observations were validated with other techniques.

[The Working Group noted that the studies assessing proteomic changes in human cells

were limited in number, and shortcomings were evident in some.]

(ii) *Transcriptomics studies in human cells*

[Remondini et al. \(2006\)](#) isolated RNA from six human-derived cell lines (NB69, EA.hy926, T lymphocytes, U937, CHME5, and HL-60) after exposure to RF radiation at 900 MHz or 1800 MHz (SAR, 1.0, 1.3, 1.4, 1.8–2.5, and 2.0) for 1, 2, or 44 hours. In some cases, the exposure at 1800 MHz was intermittent with 5/5, 5/10, or 10/20 minutes on/off. Total RNA was isolated and processed for transcriptome analysis, i.e. to detect changes in gene expression. There was no evidence of differential gene expression in three of the cell lines tested (NB69, T lymphocytes, CHME5), but alterations in gene expression (12–34 differentially expressed genes) were observed in EA.hy926, U937, and HL-60 cells under various exposure conditions. [The Working Group noted that the conclusions that could be drawn from this study were limited since the data analysis was carried out using a single RNA pool for each condition, making it impossible to estimate the true biological variance for statistical inference testing. Furthermore, no validation of results by RT-PCR was performed.]

[Zeng et al. \(2006\)](#) exposed human MCF7 breast-cancer cells to intermittent (5 minutes on, 10 minutes off) RF radiation at 1800 MHz (SAR, 2.0 or 3.5 W/kg) for 24 hours. No statistically significant differences were observed at the lower SAR, but five differentially expressed genes were detected in cells exposed at the SAR of 3.5 W/kg. [These findings were not validated with RT-PCR.]

[Hirose et al. \(2006\)](#) observed no noticeable changes in *TP53*-related gene expression in human A172 or IMR-90 cells exposed to RF radiation at 2142.5 MHz (SAR, 0.08–0.8 W/kg) for 24–48 hours. In this study the authors confirmed the absence of a response in the microarray analysis for four genes (*APAF1*, *TP53*, *TP53BP2* and *CASP9*) involved in *TP53*-mediated apoptosis

by use of RT-PCR. In a similar study, [Hirose et al. \(2007\)](#) exposed the same two cell lines to RF radiation at 2142.5 MHz (SAR, 0.08–0.8 W/kg) for 2–28 hours. Despite assessing a variety of exposure conditions, including exposure duration, signal modulation and SAR levels, the authors reported no differential expression in *hsp*-related genes under any of the conditions tested in either cell line.

[Qutob et al. \(2006\)](#) exposed human glioblastoma-derived (U87MG) cells to pulsed-wave RF radiation at 1900 MHz (SAR, 0.1, 1 or 10 W/kg) for 4 hours. There was no evidence for differential gene expression in any of the exposed samples relative to the sham-exposed cells. As a positive control, exposure to heat-shock (43 °C, 1 hour) did induce several stress-responsive genes. In an extension of this study, the same research group exposed U87MG cells to RF radiation at 1900 MHz (SAR, 0.1, 1 or 10 W/kg) for 24 hours, and harvested RNA at 6 hours after exposure. In addition, the human-derived monocyte cell line (Mono-Mac-6) was exposed under similar conditions for 6 hours, and RNA was harvested either immediately or 18 hours after exposure. No evidence for differential gene expression was observed in either cell line, at any SAR or time-point tested ([Chauhan et al., 2007a](#)).

[Huang et al. \(2008a\)](#) exposed human-derived Jurkat cells to RF radiation at 1763 MHz (SAR, 10 W/kg) for 1 hour per day, for 3 days. Genome-wide analysis did not identify any genes that were differentially expressed at a significant level ($P < 0.05$) with a greater than twofold change, but 10 genes were identified with a 1.3-fold change, with $P < 0.1$.

[Sekijima et al. \(2010\)](#) exposed three human cell lines (A172, glioblastoma; H4, neuroglioma; IMR-90 fibroblasts) to continuous-wave or W-CDMA-modulated RF radiation at 2142.5 MHz (SAR, 0.08, 0.25 or 0.8 W/kg) for up to 96 hours. Differential expression of a small number of genes was observed in each cell line. Ribosomal protein S2, growth arrest-specific

transcript 5, and integrin beta 5 were differentially expressed in H4 cells at the two higher SARs tested. [These findings were not validated with RT-PCR.]

[Sakurai et al. \(2011\)](#) assessed differential gene expression in a normal human astroglia cell-line (SVGp12) exposed to continuous-wave RF radiation 2450 MHz at (SAR, 1, 5 or 10 W/kg) for 1, 4, or 24 hours. With the high-throughput microarray, this study identified 17 genes that were upregulated and 11 that were downregulated in response to exposure to RF radiation. However, RT-PCR analysis found that the expression of these genes was not statistically different from that in the sham-exposed control group. [The Working Group noted that these results highlight the importance of proper validation of results generated by means of high-throughput screening.]

(iii) Transcriptomics studies in cultured mammalian cells

[Whitehead et al. \(2006\)](#) exposed C3H 10T $\frac{1}{2}$ mouse cells to RF radiation at 847.74 MHz (CDMA) or at 835.2 MHz (FDMA) (SAR, 5 W/kg) for 24 hours. Three independent experiments were conducted for each of the signal modulations, and matching samples were exposed to X-radiation (0.68 Gy) as positive controls. By intercomparison of the six sham-exposed samples an empirical estimate was made of the false-discovery rate. From the results of this analysis, the authors concluded that all of the gene-expression changes found after exposure to RF radiation were false positives, and that exposure to RF radiation had no effect on gene expression. No validation with RT-PCR was conducted. [The Working Group noted that genes responding to RF radiation were disregarded on the basis of the calculated false-discovery rate, rather than validated by means of RT-PCR. This was not scientifically justified as genes that were not false-positives may have been accidentally

disregarded. Therefore, this study provided little useful information.]

[Zhao et al. \(2007a\)](#) investigated the expression of genes related to apoptosis in primary cultured neurons and astrocytes isolated from ICR mouse embryos aged 15 days. The cells were exposed to GSM-modulated RF radiation at 1900 MHz (SAR not given) from a mobile phone placed over the culture dish for 2 hours. Upregulation of several genes involved in the apoptotic pathway was observed, including *Casp2*, *Casp6* and *Pycard*. For the astrocytes, these effects were exposure-dependent, and not observed after sham-exposure (with the mobile phone on “stand-by”). These results were confirmed by RT-PCR analysis. [The Working Group noted that this study had some methodological deficiencies. The cells were exposed to RF radiation from a mobile phone under poorly defined experimental conditions with regards to control for electromagnetic-field components, such as SAR levels within the cell cultures during exposure.]

In a second study, [Zhao et al. \(2007b\)](#) observed significant changes in gene expression in primary rat neurons exposed to intermittent (5 minutes on, 10 minutes off) GSM-modulated RF radiation at 1800 MHz (SAR, 2 W/kg) for 24 hours. Ten downregulated and 24 upregulated genes were identified among the 1200 genes that were screened, with “fold-change” as the analysis criterion. These findings were confirmed by RT-PCR analysis of 17 of the upregulated and 8 of the downregulated genes, showing fair agreement with the microassay data.

[Nylund et al. \(2009\)](#) examined the proteome of human endothelial cells (EA.hy926) exposed to GSM-modulated RF radiation at 1800 MHz (SAR, 2 W/kg) for 1 hour. In 2D gel-electrophoresis, eight proteins were found to be differentially expressed in exposed cells, three of which were identified as SRM, GRP78, and PSA1. Western blotting did not confirm the response of GRP78 [SRM and PSA1 not tested due to lack of specific antibodies]. No effect was seen on the

expression of vimentin or HSP27 protein, which were found to respond to radiation at 900 MHz in earlier studies (see above). In a subsequent study, [Nylund et al. \(2010\)](#) exposed umbilical vein endothelial cells (HUVEC) and human brain microvascular endothelial cells (HBMEC) to the same type of RF radiation. No effects on protein expression were reported.

[Of the numerous studies that investigated the potential for RF radiation to modify gene-transcription and protein-expression levels in a variety of animal models *in vivo* and human models *in vitro*, some reported effects under conditions where the possibility of thermal confounding could not be excluded. Other studies reported alterations in gene/protein expression under non-thermal exposure conditions, but typically in single, usually unreplicated experiments, or under experimental conditions with methodological shortcomings. There were no studies in human populations. Overall, there was weak evidence that exposure to RF radiation affects gene and protein expression.]

4.4 Other relevant effects

4.4.1 Humans

(a) Neuroendocrine system

The majority of studies on the effects of exposure to RF radiation on the endocrine system in volunteers have focused on hormones released into the blood stream by the pineal and pituitary neuroendocrine glands. Both are situated in the brain and are intimately connected with and controlled by the nervous system. Some studies have investigated urinary excretion of the major melatonin metabolite: 6-sulfatoxymelatonin (aMT6s). Fewer studies have been carried out on circulating concentrations of pituitary hormones or hormones released from other endocrine glands, such as the adrenal cortex. The pituitary hormones exert a profound influence on body metabolism and physiology, particularly during

development and reproduction, partly via their influence on the release of hormones from other endocrine glands situated elsewhere in the body. The main pituitary hormones investigated in studies on electromagnetic fields are thyroid-stimulating hormone (TSH), adrenocorticotrophic hormone (ACTH), which regulates the function of the adrenal cortex and particularly the release of cortisol, and growth hormone (GH). Pituitary hormones with important sexual and reproductive functions have also been studied, particularly follicle-stimulating hormone (FSH), luteinizing hormone (LH) and prolactin (PRL). ACTH, cortisol and prolactin are also involved in the response to stress, and were often used as a marker for the effects of exposure to RF radiation.

No cumulative effects on serum melatonin or pituitary hormones were observed after repeated exposure to RF radiation for 1 month. Most studies did not report an effect after a single exposure, but the statistical power of these studies was often insufficient because of the small number of volunteers involved ([Mann et al., 1998](#); [de Seze et al., 1999](#); [Radon et al., 2001](#); [Bortkiewicz et al., 2002](#); [Braune et al., 2002](#); [Jarupat et al., 2003](#); [Wood et al., 2006](#)).

(b) Neurobehavioural effects

(i) Electrical activity of the brain

The electroencephalogram (EEG) reflects synchronous activity in relatively large populations of cortical neurons. The “spontaneous” EEG of subjects who are awake is generally divided into several frequency bands, in which the relative amount of activity depends on the psychological state of the subject and the nature of the cognitive function in which she or he is engaged. The designation of the frequency bands is not always strictly applied, which results in specific frequencies sometimes being assigned to different bands in different studies. Generally, the following division is used: delta (δ) < 4 Hz; theta (θ) 4–8 Hz; alpha (α) 8–12 Hz; beta (β) 12–30 Hz;

and gamma (γ) > 30 Hz. Slightly different band designations are used by some authors, which are also cited in this Volume. The functional significance of these different components of the normal “waking” EEG is poorly understood. Thus, while a demonstration that mobile-phone signals influence these components would be indicative of a biological effect of such signals, interpretation of the effect would be uncertain. In addition, intra-individual variability is very high. In contrast, EEG patterns associated with sleep are well characterized and routinely used as indices of the different sleep stages that a typical healthy individual will experience during the night. Only studies on EEG during sleep are discussed here.

A review of studies on EEG during sleep and RF radiation was compiled by [Hamblin & Wood \(2002\)](#) and more recently, with a broader scope, by [Kwon & Hämäläinen \(2011\)](#). They cited studies by [Mann & Röschke \(1996\)](#), [Mann et al. \(1998\)](#), [Wagner et al. \(1998, 2000\)](#), [Borbély et al. \(1999\)](#), [Huber et al. \(2000, 2002, 2003\)](#), [Loughran et al. \(2005\)](#), [Fritzer et al. \(2007\)](#), [Hung et al. \(2007\)](#), [Regel et al. \(2007b\)](#), and [Lowden et al. \(2011\)](#). Some but not all studies on exposure to RF radiation during sleep have indicated increased EEG power in α or β bands. A reported shortening of sleep latency could not be reproduced. Other studies that looked at exposure to RF radiation for 30 minutes before going to sleep also showed variable results, sometimes reporting increases in α and β band power. In one study this was observed only after exposure to a modulated but not a continuous RF radiation signal, while in another study a dose-dependent increase in α and β power was seen. Two studies reported an increase in time taken to fall asleep. A recent study by [Lowden et al. \(2011\)](#) indicated that self-reported differences in sensitivity to emissions from mobile-phone use were not reflected in sleep parameters.

[The Working Group concluded that exposure to a GSM-type signal may result in minor effects on brain activity during sleep.]

(ii) Auditory and vestibular systems

As mobile phones are held close to the ear, various studies have checked for possible effects of exposure to mobile-phone type (GSM) RF radiation on the vestibular (balance) and cochlear (auditory) organs that comprise the inner ear. The hair-cell receptors present in each organ respond to head movement or to audible sound. This topic was recently reviewed by [Kwon & Hämäläinen \(2011\)](#), who concluded that neurophysiological studies showed no significant effects on cochlear and brainstem auditory processing, or on the vestibular system. [The Working Group noted that the results on spontaneous and evoked electrical activity in the brain were inconsistent.]

(iii) Cognitive performance

Studies on cognitive performance in relation to exposure to RF radiation have been carried out in healthy adult volunteers, in adults who self-reported a variety of symptoms such as headaches in the vicinity of RF sources, and in children and adolescents, following the recommendations of [IEGMP \(2000\)](#).

Dynamic changes in brain anatomy occur throughout childhood and adolescence. The amount of white matter, which corresponds to myelination of nerve axons and is related to the speed of neuronal processing, increases linearly throughout adolescence. Changes in the amount of grey matter are thought to reflect changes in size and complexity in neurons, such as the number of synaptic connections, rather than changes in number of neurons themselves. These changes are considered to be related to maturation of behaviour; they are more complex and continue into the early 20s ([Giedd, 2004](#)).

Reviews of studies on neurobehavioural effects of exposure to RF radiation have been compiled by [Barth et al. \(2008\)](#) and more recently

by [Kwon & Hämäläinen \(2011\)](#). The latter authors indicated that improvement of cognitive performance after exposure to RF radiation, as reported in earlier studies, had not been confirmed in more recent behavioural studies with improved analyses.

(iv) Subjective symptoms

Some people self-report having a variety of subjective complaints, including headaches and migraines, fatigue, skin itches, and sensations of heat, after exposure to RF radiation ([Frey, 1998](#); [Hocking, 1998](#); [Chia et al., 2000](#); [Hocking & Westerman, 2000](#); [Sandström et al., 2001](#); [Santini et al., 2002a, b](#)). These symptoms are attributed to exposures at home or at work to RF radiation emitted by mobile phones, nearby base stations, digital enhanced cordless telecommunications (DECT) cordless phones and, more recently, wireless local area network (LAN) systems. Less commonly reported symptoms include dizziness, blurred vision, memory loss, confusion and vagueness, toothaches, and nausea. An increasing number of these people consider themselves to be electrosensitive. Provocation studies provide the most direct way of studying a possible effect of exposure to RF radiation on the occurrence of such symptoms. A weakness of these studies is that they focus on direct, short-term interactions, while symptoms may only occur after a longer exposure. In their review, [Kwon & Hämäläinen \(2011\)](#) conclude that provocation studies provided no evidence that the subjective symptoms could be attributed to mobile-phone use, which suggests that there are other explanations for the induction of such symptoms in hypersensitive people.

(c) Thermal effects and thermoregulation

There is an established literature on cardiovascular responses to heating associated with exposure to RF radiation, such as those involved in thermoregulation. Several studies addressed these end-points in connection with

thermoregulation and heat-stress disorders, to place the possible health consequences of such heating into a broader occupational and environmental context ([ICNIRP, 2009](#)).

RF energy is absorbed by the body, resulting in the production of heat due to an increase in molecular rotational and translational kinetic energy. The absorbed heat energy is distributed throughout the body in the circulation and is partially lost to the external environment. Significant whole-body heating has a major impact on cardiovascular physiology. In addition, the ability to carry out cognitive tasks is compromised before physiological limits of tolerance are reached ([Hancock & Vasmatazidis, 2003](#)). [ICNIRP \(2009\)](#) has indicated that adequately hydrated, inactive, healthy volunteers exposed to RF radiation under laboratory conditions will accommodate whole-body heat loads of approximately 1 W/kg for 45 minutes at environmental temperatures of up to 31 °C, to 6 W/kg for at least 15 minutes at ambient temperatures, with increased skin blood-flow and profuse local sweating, but with minimal changes in core temperature. With regard to local heating of the skin, skin blood-flow and local sweating increase with increasing skin temperature by up to 4 °C in response to a local peak SAR of about 15 W/kg at the irradiated site, but it is not known how less superficial and less vascular tissues may respond.

A full assessment of whole-body heat stress can only be properly derived from a consideration of all sources of heat and from the ease with which heat can be lost from the body, as given by the heat-balance equation. Heat gain through solar radiation or other sources of radiant heat may also have to be taken into account. The main adverse health effects expected to result from excessive heat loads are heat-related disorders such as heat exhaustion and, in elderly people, an increase in the risk of heat-related mortality ([Lakatta, 2002](#)). These effects are well documented in people exposed to hot environments and in elderly people during prolonged periods

of hot weather, but have not been associated with exposure to RF radiation. In addition, adverse effects on cognitive function may be expected to result from increased body temperature, with the potential to increase accident rates, but this has proven to be difficult to quantify in studies with volunteers. Several studies of acute exposure have been carried out to assess the adverse effects of increased tissue temperature in experimental animals, often in the context of providing guidance on the use of ultrasound or hyperthermia treatments in clinical practice ([Ryan et al., 1997](#)). Lesions, including those that result from cell death, generally occur when temperatures exceed 42 °C for more than about 1 hour. The central nervous system and testes appear to be particularly susceptible to heat-induced damage and show significant changes in cell numbers after exposures to 40–41 °C and higher.

Studies on mobile-phone use by volunteers have investigated the effects of RF radiation from mobile phones at levels generally assumed to be too low to induce significant heating. In principle, such “athermal” effects on the cardiovascular centres of the brainstem, which regulate the heart and circulation via outflow in the sympathetic and parasympathetic systems, are possible ([Benham et al., 2003](#); [Patapoutian et al., 2003](#); [Moran et al., 2004](#); [Glaser, 2005](#); [Bandell et al., 2007](#); [Foster & Glaser, 2007](#)). Several studies focused on possible effects on heart rate, heart-rate variability, blood pressure and cerebral blood flow. There is no clear evidence of an effect of such exposure on resting heart rate or blood pressure. However, small but inconsistent variations in heart-rate variability have been reported.

(d) *Cerebral blood flow and neural biochemical activity*

Changes in regional cerebral blood flow could reflect (or cause) local changes in neural activity. There are some indications of changes in regional cerebral blood flow during and after exposure to RF radiation. In their review, [Kwon](#)

[& Hämäläinen \(2011\)](#) concluded that approaches such as measurement of the haemodynamic response in the brain were promising, but the findings were few and not conclusive. The studies reviewed were [Braune et al. \(1998, 2002\)](#), [Reid & Gettinby \(1998\)](#), [Borbély et al. \(1999\)](#), [Huber et al. \(2000, 2002, 2003, 2005\)](#), [Haarala et al. \(2003a\)](#), [Sandström et al. \(2003\)](#), [Tahvanainen et al. \(2004\)](#), [Aalto et al. \(2006\)](#), [Nam et al. \(2006\)](#), [Barker et al. \(2007\)](#), and [Parazzini et al. \(2007\)](#). Also linked to cerebral blood flow, a more recent study by [Volkow et al. \(2011\)](#) using glucose-uptake positron-emission tomography (PET) showed an increase in local cerebral metabolism after exposure to a mobile phone in reception mode.

[The small changes seen in electrical activity in the brain and possibly in regional cerebral blood flow may not have functional significance. No consistent effects on cognitive performance have been found, although the use of a large variety of techniques to assess cognitive performance makes it difficult to directly compare the results of different studies. No research data were available that would link these findings to cancer.]

4.4.2 *Experimental systems: in vivo*

(a) *Oxidative stress*

Numerous experiments have been conducted to explore the possibility that exposure to RF radiation may trigger oxidative stress in tissues of exposed animals (most frequently rats). Markers of oxidative stress include increased levels of malondialdehyde (indicative of lipid peroxidation), nitric oxide (NO), and reduced glutathione (GSH), and the activities of antioxidant enzymes such as SOD, catalase, or GSH-Px, or of pro-oxidant enzymes such as xanthine oxidase (XO).

(i) *Brain*

[Many of the studies in this section used a mobile phone as the source of exposure to RF radiation, which limits the value of these studies in hazard identification.]

[Irmak et al. \(2002\)](#) exposed male rabbits to radiation from a commercially available GSM mobile phone (900 MHz; peak power, 2 W; average power density, 0.02 mW/cm²) for 30 minutes per day, for 7 days. The telephones were positioned “in close contact with the rabbits.” The concentrations of malondialdehyde and NO, and activities of several relevant enzymes were measured in brain and serum of exposed and sham-exposed rabbits. No significant changes were noted in any parameter in the brain; a significant increase in SOD activity ($P = 0.042$) and a significant decrease in concentrations of NO ($P = 0.004$) were observed in the serum of exposed rabbits.

[Ilhan et al. \(2004\)](#) exposed female rats to a GSM signal from a mobile phone (900 MHz; continuous wave; analogue phone), 1 hour per day, for 7 days, at SARs of 2 W/kg (brain) or 0.25 W/kg (whole body), with or without administration of a *Ginkgo biloba* extract. Treatment with this extract by daily oral gavage started 2 days before and was continued throughout the 7 days of exposure to RF radiation. Immediately after exposure, histopathological changes and biochemical markers of oxidative stress were evaluated in the brain. “Dark” neurons (degenerative neurons that can be visualized by staining with cresyl violet) were detected in all locations, particularly in the cortex, hippocampus and basal ganglia. The concentrations of NO and malondialdehyde, and the activities of the enzymes XO and adenosine deaminase were increased in brain tissues, while the activities of SOD and glutathione peroxidase were decreased. Co-exposure with the *Ginkgo biloba* extract prevented these effects. [The Working Group noted that the experimental protocol in this study

was imprecise. The SAR was given without any information on how it was derived; the mention of analogue with GSM was contradictory.]

[Elhag et al. \(2007\)](#) exposed rats of unspecified strain and sex to RF radiation from a GSM mobile phone (900 MHz) for either 1 hour, or for 15 minutes per day, for 4 days, at a SAR of 0.25 W/kg, and reported a reduction in concentrations of vitamins C and A in serum, a decreased level of vitamin E in erythrocytes, and a reduction in the activities of catalase and SOD and concentrations of reduced glutathione in erythrocytes. [The Working Group noted the imprecise experimental protocol of this study, and did not take the results into further consideration.]

[Meral et al. \(2007\)](#) exposed guinea-pigs to RF radiation at 890–915 MHz (SAR, 0.95 W/kg) from a mobile phone for 12 hours per day (11 hours 45 minutes “stand-by” and 15 minutes “on”) for 30 days. At the end of the exposure period, lipid peroxidation, enzymatic activities and vitamins in blood and brain tissue were measured biochemically, and compared between exposed and non-treated controls. Increased concentrations of malondialdehyde, and reduced glutathione concentrations and catalase enzyme activity were observed in brain tissue, but there was no change in levels of vitamins A, E and D₃ in the brain. In the blood of the exposed animals, increased concentrations of malondialdehyde, vitamins A, D₃ and E, and catalase enzyme activity were seen, as well as decreased levels of glutathione. [The Working Group noted the lack of sham-exposed controls.]

[Ammari et al. \(2008\)](#) studied the activity of cytochrome oxidase in the brain of rats exposed to RF radiation at 900 MHz (GSM) from an RF generator, for 15 minutes per day for 7 days at a SAR (brain) of 6 W/kg, or for 45 minutes per day for 7 days at a SAR of 1.5 W/kg. While exposure at the lower SAR had no effect, exposure at a SAR of 6 W/kg induced a decrease in the activity of cytochrome oxidase in some areas of the rat brain (frontal cortex, posterior

cortex, hippocampus and septum). [This result showed that GSM signals at high SAR may affect the activity of cytochrome oxidase in the brain, which is a metabolic marker of neuronal activity.]

[Sokolovic et al. \(2008\)](#) exposed male rats to continuous-wave RF radiation at 900 MHz (GSM) from a mobile phone placed in the cage, for 4 hours per day during the light period (06:00–18:00) for 20, 40 or 60 days, at an estimated whole-body SAR of 0.043–0.135 W/kg, with or without daily intraperitoneal injections of melatonin (2 mg/kg bw) or saline. A false phone was placed in the cages of the control groups and the groups receiving melatonin only. A significant 20–50% increase in brain concentrations of malondialdehyde and carbonyl groups was observed during exposure. Catalase activity was decreased (–20%) during exposure, while the activity of XO was increased (15–25%) after 40 and 60 days of exposure. Treatment with melatonin prevented increases in malondialdehyde content and XO activity in brain tissue after 40 and 60 days of exposure.

[Dasdag et al. \(2009\)](#) exposed male Wistar rats to RF radiation at 900 MHz (GSM) delivered to the head for 2 hours per day, 7 days per week, for 10 months. No difference was found in oxidative-stress indexes between the groups, while total oxidant capacities and catalase in the brain were significantly higher ($P < 0.05$) in the exposed group than in the sham-exposed group.

[Imge et al. \(2010\)](#) exposed female rats to RF radiation at 900 MHz (GSM) from a mobile phone (SAR, 0.95 W/kg) placed 10 cm above the cages, for 4 × 10 minutes per day, for 4 weeks, with or without daily oral administration of vitamin C (250 mg/kg bw). The activities in brain tissue of 5'-nucleotidase and catalase were significantly reduced compared with those of the non-treated control group, and there was a non-significant reduction in the activity of glutathione peroxidase and in concentrations of malondialdehyde in the brain. Vitamin C had a protective effect

in some of these analyses. [The Working Group noted the lack of sham-exposed controls.]

(ii) *Kidney*

The justification for studying oxidative stress in the kidney following exposure to electromagnetic fields stems from the fact that the kidney would be the organ with the greatest exposure when a mobile phone is worn at the belt.

[Oktem et al. \(2005\)](#) exposed groups of eight Wistar albino rats to RF radiation at 900 MHz (GSM; average power density, 1.04 mW/cm²) for 30 minutes per day for 10 days, with or without treatment with melatonin (100 µg/kg bw; subcutaneous injection) before the daily exposure to RF radiation. SAR values were not reported. Increases in tissue concentrations of malondialdehyde and urinary *N*-acetyl-β-D-glucosaminidase (NAG), a marker of renal tubular damage, were observed. The activities of SOD, catalase, and GSH-Px were reduced. Administration of melatonin reversed or prevented these effects.

The same group ([Ozguner et al., 2005b](#)) compared the protective effects of melatonin (100 µg/kg bw; subcutaneous injection) and of caffeic acid phenethyl ester (CAPE; dose unclear), a component of honey-bee propolis used in traditional medicine, in Sprague-Dawley rats exposed to RF radiation. The experimental protocol was similar to that of [Oktem et al. \(2005\)](#), with antioxidants being injected daily for 10 days before exposure to RF radiation at 900 MHz (GSM; average power density, 1.04 mW/cm²). Urinary NAG and renal MDA were increased, while renal SOD and GSH-Px were decreased. Melatonin and CAPE reversed or prevented many of these effects, with melatonin being the more potent antioxidant. The results were similar to those reported previously, with the exception of catalase, the activity of which was not modified.

(iii) Myocardium

[Ozguner et al. \(2005a\)](#) assessed the protective effects of CAPE in myocardium of Sprague-Dawley rats exposed to RF radiation at 900 MHz, using an experimental protocol similar to that used for studies in the kidney (see above) and found comparable results.

(iv) Eye

[Ozguner et al. \(2006\)](#) compared the protective effects of melatonin and CAPE (a component of honey-bee propolis used in traditional medicine) on oxidative stress induced in rat retina by exposure to RF radiation at 900 MHz (whole-body SAR, 0.016 W/kg; local SAR at the head, 4 W/kg). The experimental protocol was similar to that in [Ozguner et al. \(2005b\)](#): antioxidants were injected daily for 60 days (rather than 10 days) before exposure to RF radiation for 30 minutes per day for 60 days (rather than 10 days). Significantly increased ($P < 0.0001$) retinal concentrations of NO and MDA were found in exposed rats, which remained at control values after pre-treatment with melatonin and CAPE. Likewise, the activities of SOD, GSH-Px and CAT were significantly reduced in the retina of exposed rats. Again, prior treatment with melatonin and CAPE prevented this reduction in the activities of these antioxidant enzymes. These data indicated that antioxidants reduce oxidative stress in the rat retina caused by long-term exposure to RF radiation. [The Working Group was uncertain about the dosimetry in this study, and noted the lack of a cage-control group to assess the effect on the rats of being restrained in a tube during the exposures.]

[Balci et al. \(2007\)](#) exposed female rats to RF radiation at 900 MHz from a mobile phone (GSM; SAR, 1.2 W/kg), placed 10 cm above the cages, for 4 × 10 minutes per day, for 4 weeks, with or without daily oral administration of vitamin C (250 mg/kg bw). In the cornea, a significant increase was found in the concentration of malondialdehyde and in the activity of

catalase compared with the control group and with the exposed group receiving vitamin C, while the activity of SOD was decreased. In the lens tissues, the malondialdehyde concentration was significantly increased, but no significant differences in the activities of SOD, GSH-Px or catalase were observed. The presence of vitamin C generally diminished the effects of exposure to RF radiation. [The Working Group noted several design flaws in this study (e.g. the exposure system, the absence of dosimetry, absence of sham-exposed controls) and did not further consider these results.]

(v) Liver

[Ozguner et al. \(2010\)](#) investigated oxidative damage and antioxidant-enzyme status in the liver of guinea-pigs exposed to RF radiation at 1800 MHz (GSM; SAR, 0.38 W/kg) for 10 or 20 minutes per day, for 7 days. In this study the potential protective effects of *N*-acetylcysteine (NAC) and epigallocatechin-gallate (EGCG) were also investigated. A significant increase in the concentrations of malondialdehyde and nitrogen oxides (NO_x) and a reduction in the activities of SOD, myeloperoxidase and GSH-Px were observed in the liver of exposed guinea-pigs. Some of these changes appeared to be proportional to the duration of exposure). In addition, treatment with NAC induced an increase in hepatic GSH-Px activities, whereas treatment with EGCG attenuated concentrations of malondialdehyde.

[Tomruk et al. \(2010\)](#) evaluated the effects of whole-body exposure to RF radiation at 1800 MHz (GSM) for 15 minutes per day, for 1 week, on oxidative DNA damage and lipid peroxidation in the liver of nonpregnant or pregnant New Zealand White rabbits, and in their newborns. Concentrations of malondialdehyde increased significantly in exposed nonpregnant and pregnant animals compared with nonpregnant controls, but there was no difference between exposed and sham-exposed pregnant rabbits. The same results were observed with lipid

peroxidation, measured by means of the ferrous oxidation-xylenol orange [FOX] assay. Exposure to RF radiation had no effect on the amount of oxidative DNA damage (8-OHdG adducts) in the liver of RF-exposed and sham-exposed nonpregnant and pregnant rabbits. No differences in concentrations of malondialdehyde and 8-OHdG were found in the liver of newborns exposed to RF radiation *in utero* compared with newborns of sham-exposed mothers. However, a significant reduction in lipid peroxidation, *i.e.* reduced FOX levels, in the liver of RF-exposed newborns was observed. [The Working Group noted that SAR values were not stated.]

(vi) *Miscellaneous*

[Mailankot et al. \(2009\)](#) exposed adult male Wistar albino rats to RF radiation at 900/1800 MHz (SAR not given) from a GSM mobile phone “in active mode” for 1 hour per day for 28 days, while control rats were exposed to a mobile phone “without battery.” There was no difference in sperm counts in the epididymis between exposed and control rats, but a 40% reduction in the proportion of motile sperm was observed after exposure. In addition, the concentration of malondialdehyde was significantly increased and intracellular GSH was significantly reduced in the testis and epididymis of exposed rats, compared with sham-exposed controls, together with a significant decrease in intracellular GSH in both testis and the epididymis of RF-exposed rats.

[Kumar et al. \(2010\)](#) exposed male Wistar rats to continuous RF radiation at 10 or 50 GHz (SAR, 0.014 and 0.0008 W/kg, respectively) for 2 hours per day, for 45 days. Total levels of ROS and catalase activity were higher and the proliferative index, and the activities of SOD and reduced GSH-Px in the serum were lower in exposed rats than in sham-exposed controls.

(b) *Differentiation and apoptosis*

[Dasdag et al. \(2003\)](#) exposed male Sprague-Dawley rats to RF radiation at 900 MHz from commercially available mobile phones (average calculated whole-body SAR, 0.52 W/kg; peak SAR, 3.13 W/kg) for 20 minutes per day, 7 days per week, for 1 month. The mobile phones were placed 0.5 cm under the cages. There were no differences between exposed and sham-exposed groups in terms of structure of testes, sperm counts, phospholipid composition or Tp53 immunoreactivity. [The Working Group noted the ill-defined exposure set-up and the approximate SAR calculations.]

In a study mentioned before, [Dasdag et al. \(2009\)](#) exposed male Wistar rats to RF radiation at 900 MHz (GSM; SAR, 0.19–0.58 W/kg) delivered to the head for 2 hours per day, 7 days per week, for 10 months. The apoptosis score – based on immunostaining of active caspase-3 – in the brain of the exposed rats was significantly lower than in sham-exposed or cage-control rats.

Apoptosis induced in the endometrium was studied by [Oral et al. \(2006\)](#) by exposing female Wistar albino rats in a plastic tube to RF radiation at 900 MHz (GSM) (SAR, 0.016–4 W/kg) for 30 minutes per day, for 30 days. Different group of rats received vitamin E (50 mg/kg bw) or vitamin C (20 mg/kg bw) by intramuscular or intraperitoneal injection, respectively, just before the daily exposure to RF radiation. Increased concentrations of malondialdehyde (indicative of lipid peroxidation) and enhanced apoptosis were observed in endometrial tissue (stromal cells) of exposed rats. These effects were partly reverted by vitamin treatment. Using the same experimental protocol, [Guney et al. \(2007\)](#) observed an increase in oxidation products (NO, malondialdehyde), a decrease in activities of antioxidant enzymes (SOD, catalase, GSH-Px), and diffuse and severe apoptosis in the endometrial surface epithelial and glandular cells and in

stromal cells. [Both studies lacked details on SAR measurement.]

[Odaci *et al.* \(2008\)](#) examined paraffin-embedded sections of the brain of rats aged 4 weeks born from females exposed to RF radiation at 900 MHz (GSM; calculated whole-body SAR, 2 W/kg), for 60 minutes per day during the entire gestation period. A slight but statistically significant reduction in the number of granule cells in the dentate gyrus of pups of exposed dams was observed; this reduction may affect postnatal behavioural and cognitive functions. [The Working Group noted the apparent lack of a sham-exposed control group.]

More recently, [Sonmez *et al.* \(2010\)](#) examined paraffin-embedded sections of the cerebellum of female rats aged 16 weeks exposed to RF radiation at 900 MHz (calculated average SAR, 0.016 and 2 W/kg, respectively, for whole-body or head-only) for 1 hour per day, for 28 days. A significant reduction in the number of Purkinje cells was observed in the cerebellum of exposed rats compared with sham-exposed controls and cage controls.

[The Working Group concluded that there was weak evidence that exposure to RF radiation at 900 MHz induces differentiation or apoptosis in the brain or endometrium of exposed rats.]

(c) *Blood–brain barrier*

The blood–brain barrier regulates exchange between blood and the brain. An increase in the normally low permeability of this barrier for hydrophilic and charged molecules after exposure to RF radiation could potentially be detrimental by enabling the extravasation of substances that could potentially act as brain carcinogens.

In vivo, several methods have been used to evaluate the integrity of the blood–brain barrier. These methods are based either on assessment of the permeability of the barrier to endogenous molecules such as albumin, which can be visualized by immunohistochemistry on brain sections, or on the injection of dyes (Evans

blue) or labelled molecules that do not cross the blood–brain barrier under normal physiological conditions and hence may serve as permeability markers. Models of brain injury (e.g. cold injury or chemical injury) are informative positive controls in these experiments. Another method comprises the evaluation of alterations in nervous tissue by detecting degenerating neurons (“dark neurons”) through staining with cresyl violet, or with the fluorescent molecule Fluoro-Jade B, which is more specific for neurons.

Dozens of experiments in rodents have assessed the functioning of the blood–brain barrier in animals exposed to various intensities of RF radiation at frequencies \geq 900 MHz (for reviews, see [Stam, 2010](#) and [Nittby *et al.*, 2011](#)). Here are described only experimental studies of exposure at frequencies \geq 900 MHz and at exposure levels that did not – or were unlikely to – produce a thermal effect: in the rat brain, hyperthermia of > 1 °C induces alterations in the blood–brain barrier. It should be noted also that anaesthesia itself may modify the permeability of the blood–brain barrier.

One research group has reported effects on the permeability of the blood–brain barrier and alterations in nervous tissue (dark neurons) after exposure of Fisher 344 rats (males and females) to continuous or GSM-modulated RF radiation at 900 and 915 MHz, with SARs of 2–5 W/kg. Among recently published studies from this group, three ([Eberhardt *et al.*, 2008](#); [Nittby *et al.*, 2009, 2011](#)) reported an increase in permeability to albumin at 1 or 2 weeks after 2 hours of exposure to a 900 MHz GSM signal (SAR, 0.0001–0.13 W/kg). Another study from this group ([Grafström *et al.*, 2008](#)) assessed permeability of the blood–brain barrier 5–7 weeks after exposure to a GSM signal (SAR, 0.0006–0.6 W/kg) for 2 hours per week for 55 weeks, and found no increase in permeability using several markers, and no appearance of dark neurons.

[Masuda *et al.* \(2009\)](#) did not observe albumin extravasation or appearance of dark neurons

in experiments in two-compartment transverse electromagnetic (TEM) transmission line cells. Male Fischer F344 rats were exposed to a 915 MHz GSM signal (whole-body SAR, 0.02, 0.2 or 2 W/kg) for 2 hours. Positive controls (cold and chemical injury) were included. Analyses were performed 14 and 50 days after exposure.

[McQuade et al. \(2009\)](#) did not observe any leakage of albumin across the blood–brain barrier in male Fischer 344 rats sham-exposed or exposed to 915 MHz RF radiation (SAR, 0.0018–20 W/kg) for 30 minutes in TEM cells. Both continuous-wave and pulsed modes of 16 and 217 Hz were used, with pulse parameters based on those in studies from the research group mentioned above ([Persson et al., 1997](#)). Positive controls (hyperthermia at 43 °C, and urea 10 M) were included. Albumin extravasation was investigated by immunohistochemical staining of brain sections. A subset of the microscopic slides was sent to Sweden and analysed by scientists associated with the original studies. No alterations in the blood–brain barrier were observed at any exposure level.

[De Gannes et al. \(2009\)](#) found no changes in the integrity of the blood–brain barrier or neuronal degeneration in Fischer 344 rats exposed head-only to a 900 MHz GSM signal (brain-averaged SAR, 0.14 or 2 W/kg) for 2 hours. Complete numerical and experimental dosimetry was included in this study. Albumin leakage, dark neurons, or changes in neuronal apoptosis were not observed. [It is worthy of note that in these three studies, homogeneous samples of male rats of the same age and weight were used. The SAR values tested were higher or of a wider power range than in experiments of the Swedish group.]

[The Working Group concluded that despite consistent results from one laboratory, the experimental evidence did not support the notion that non-thermal RF radiation affects the permeability of the blood–brain barrier.]

4.4.3 Experimental systems: in vitro

(a) Human cells

(i) Free radicals and ROS

Free radicals are highly reactive molecules that carry unpaired electrons in the outer orbit. Free radicals that are derived from oxygen metabolism are known as reactive oxygen species (ROS). These radicals are continuously neutralized by antioxidants present in body tissues. When production of these species exceeds the scavenging capacity of antioxidants, oxidative stress results. Production of radicals is a known pathway involved in the development of cancer.

[Lantow et al. \(2006a, c\)](#) measured production of ROS and expression of HSPs (described in section 4.3.2.c (i)) in human Mono Mac 6 and K562 cells exposed to RF radiation at 1800 MHz (SAR, 0.5, 1.0, 1.5 or 2.0 W/kg) as three different GSM modulation signals, for 45 minutes. Heat and phorbol 12-myristate-13-acetate (PMA) induced a significant increase in superoxide radical anions and in the production of ROS. In general, no effects were observed from exposure to RF radiation alone or in combination with PMA or lipopolysaccharide. [Lantow et al. \(2006b\)](#) used human umbilical cord blood-derived monocytes and lymphocytes to examine release of ROS after continuous or intermittent (5 minutes on, 5 minutes off) exposure at 1800 MHz (SAR, 2 W/kg) for 30 or 45 minutes. Exposure to RF radiation did not enhance the effects of PMA. In another study from the same group, [Simkó et al. \(2006\)](#) exposed human Mono Mac 6 cells to RF radiation under similar conditions, but combined exposures were carried out with ultrafine particles. Exposure to RF radiation alone had no effect on radical production. In addition, RF radiation did not enhance the production of superoxide anion radicals induced by ultrafine particles.

[Luukkonen et al. \(2009\)](#) investigated intracellular production of ROS and DNA-damage induction in human SH SY5Y neuroblastoma

cells exposed to continuous-wave or pulsed-wave RF radiation at 872 MHz (SAR, 5 W/kg) for 1 hour. The experiments also involved combined exposure to RF radiation and menadione. The production of ROS was measured by use of the fluorescent probe dichlorofluorescein. No effects were seen from exposure to RF radiation alone. Consistent with the increase in DNA damage (described in Section 4.1.3.b.ii), the level of ROS measured after treatment with menadione was higher in cells exposed to a continuous-wave RF field. However, no effects of the pulsed-wave RF radiation were seen at identical SARs. In a second study using identical exposure conditions and the same cell line, [Luukkonen et al. \(2010\)](#) found no effects on ROS production induced by ferrous choride from continuous-wave or pulsed-wave RF radiation. This finding was consistent with lack of effect on DNA-damage induction in the same study, as described earlier.

[Höytö et al. \(2008a\)](#) exposed human SH-SY5Y neuroblastoma cells and mouse L929 fibroblasts to continuous-wave or GSM-modulated RF radiation at 872 MHz (SAR, 5 W/kg) for 1 hour or 24 hours, under isothermal conditions. To investigate possible combined effects with other agents, menadione was used to induce ROS, and *tert*-butylhydroperoxide (*t*-BOOH) was used to induce lipid peroxidation. After the 1-hour exposure, there was a statistically significant enhancement by RF radiation of *t*-BOOH-induced lipid peroxidation in SH-SY5Y cells exposed to the GSM-modulated signal. After the 24-hour exposure, there was a statistically significant increase by RF radiation of menadione-induced caspase-3-like protease activity in mouse L929 fibroblasts exposed to the GSM-modulated signal. No effects were seen in any of the other experimental conditions, or from exposure to RF radiation alone.

Purified human spermatozoa were exposed to RF radiation at 1800 MHz (SAR, 0.4 W/kg to 27.5 W/kg) ([De Iuliis et al., 2009](#)). With increasing SAR, motility and vitality of the sperm cells were significantly reduced after exposure,

while the mitochondrial generation of ROS and DNA fragmentation were significantly elevated. Furthermore, highly statistically significant relationships between SAR, the oxidative DNA damage biomarker 8-OHdG, and DNA fragmentation were observed in exposed cells. The temperature during these experiments was kept at 21 °C; the highest observed exposure-induced temperature increase was +0.4 °C, at SAR 27.5 W/kg; control experiments in which spermatozoa were incubated at 21 °C–50 °C – without RF radiation – indicated that the end-points measured were only significant above 40 °C.

Human sperm was exposed *in vitro* for 1 hour to RF radiation at 850 MHz (SAR, 1.46 W/kg) from a mobile phone in talk mode, and markers of oxidative stress were evaluated ([Agarwal et al., 2009](#)). The results showed a significant increase in production of ROS in exposed samples and a decrease in sperm motility, viability, and in the ROS-total antioxidative capacity (ROS-TAC) score in exposed samples.

[The Working Group concluded that there was weak evidence that RF radiation activates a stress response or production of ROS in human cells under non-thermal conditions.]

(ii) Cell proliferation

[Kwee & Raskmark \(1998\)](#) exposed human AMA epithelial amnion cells to RF radiation at 960 MHz (GSM; SAR, 0.021, 0.21 or 2.1 mW/kg) for 20, 30, and 40 minutes at 37 °C. Cellular proliferation was assessed by means of the formazan test, and found to decrease linearly with exposure time at the lowest and highest SAR level. In a follow-up study, [Velizarov et al. \(1999\)](#) exposed human AMA cells to RF radiation at 960 MHz (GSM; SAR, 2.1 mW/kg) for 30 minutes at two different temperatures (39 °C and 35 °C), to evaluate whether the earlier results (see above) were temperature-dependent. There was a marginally significant reduction in cellular proliferation rate – measured with the formazan test – after the 30-minute exposure at both

temperatures ($P = 0.086$ and 0.072 , respectively, based on 11 independent experiments); the change in proliferation rate of the sham-exposed cells was not different at the two temperatures tested. The authors considered it unlikely that the effect of exposure to RF radiation on cell proliferation was a thermal effect.

[Pacini et al. \(2002\)](#) exposed human Detroit 550 skin fibroblasts to RF radiation at 960 MHz (GSM; estimated SAR, 0.6 W/kg) for 60 minutes. The radiation source was a mobile phone placed underneath the culture dish. No changes in the rate of cell replication were seen, as tested by [^3H] thymidine incorporation. [The use of a mobile phone as a radiation source made this study difficult to interpret; with only three replicates, the sample size was small.]

[Capri et al. \(2004a\)](#) exposed peripheral blood mononucleated cells from healthy volunteers to RF radiation at 900 MHz (GSM or continuous-wave; average SAR, 70–76 mW/kg) for 1 hour per day, for 2 or 3 days. Cells were treated with the mitogens PHA or alphaCD3 to stimulate replication. A statistically significant ($P = 0.04$) decrease in cell replication – as judged by [^3H] thymidine incorporation – was seen only for the cells exposed to the GSM RF-radiation and stimulated with the lowest dose of PHA; all other differences were non-significant. There was no effect at all after exposure to the continuous-wave RF radiation.

[Marinelli et al. \(2004\)](#) exposed human CCRF-CEM T-lymphoblastic leukaemia cells to continuous-wave RF radiation at 900 MHz (SAR, 3.5 mW/kg) for 2, 4, 12, 24, or 48 hours. There was a significant decrease in total viable cell number after 24 and 48 hours of exposure, and a significant increase in the percentage of apoptotic cells – measured by fluorescence-activated cell sorting (FACS) analysis – after 2 hours, which gradually diminished but remained significant after 24 and 48 hours of exposure. In addition, after 48 hours the number of cells that had started S-phase had increased, while the percentage of

cells in growth-arrest diminished. These data support the notion that RF radiation may lead cancer cells to acquire an advantage to survive and proliferate. [The Working Group had some difficulty in understanding the description of the exposure conditions in this study.]

[Sanchez et al. \(2006b\)](#) exposed reconstructed human primary keratinocytes to RF radiation at 900 MHz (GSM; SAR, 2 W/kg) for 48 hours. No apoptosis was induced in these cells, and there was no alteration of cell proliferation. A small increase in expression of heat-shock protein (Hsp) 70 was noted after 3 and 5 weeks of culture. [Merola et al. \(2006\)](#) exposed human LAN-5 neuroblastoma cells to RF radiation at 900 MHz (GSM; SAR, 1 W/kg) for 24, 48 or 72 hours, and found no effects on cellular replication. [Gurisik et al. \(2006\)](#) exposed human SK-N-SH neuroblastoma cells and monocytic U937 cells to 900 MHz (GSM-modulated) RF radiation (SAR of 0.2 W/kg) for 2 hours. There were no effects on cell-cycle distribution, apoptosis, or HSP levels. [Lantow et al. \(2006c\)](#) exposed human macrophagic Mono Mac 6 cells to pulse-modulated RF radiation at 1800 MHz (GSM-DTX; SAR, 2 W/kg) for 12 hours. No changes in cell-cycle distribution or cell proliferation were reported. [Takashima et al. \(2006\)](#) exposed human MO54 glioma cells to 2450 MHz continuous-wave RF radiation (SAR, 0.05, 0.5, 5, 50, 100, 200 W/kg) for 2 hours, or to intermittent RF radiation at 2450 MHz (mean SAR, 50 or 100 W/kg) for 2 hours. Exposure to continuous-wave RF radiation at 200 W/kg caused a decrease in cell replication and cell survival. Other exposures had no effect. [It should be noted that the temperature of the medium increased to 44.1 °C at exposures with SAR of 200 W/kg.] [Sun et al. \(2006\)](#) exposed human lens epithelial cells to GSM-modulated RF radiation at 1800 MHz (SAR, 1, 2, 3, 4 W/kg) for 2 hours. No effects of RF exposure were observed on cell proliferation (incorporation of bromodeoxyuridine) up to 4 days after exposure. [Chauhan et al. \(2007b\)](#) exposed human lymphoblastoid TK6,

lymphoblastic HL60 and myeloid Mono Mac 6 cells to intermittent (5 minutes on, 10 minutes off) pulse-modulated RF radiation at 1900 MHz (SAR, 1 and 10 W/kg) for 6 hours. There were no effects on cell-cycle progression.

[The Working Group concluded that there was weak evidence that exposure to RF radiation affects cell proliferation.]

(iii) Apoptosis

Defects in apoptosis-signalling pathways are common in cancer cells; apoptosis is an important mechanism by which damaged cells are removed, thus preventing the proliferation of potential cancer cells.

[Marinelli et al. \(2004\)](#) reported increased apoptosis, determined by flow cytometry and DNA-ladder analysis, in human CCRF-CEM T-lymphoblastoid leukaemia cells exposed to continuous-wave RF radiation at 900 MHz (SAR, 0.0035 W/kg) for 2–48 hours. Measurement of gene expression indicated activation of both TP53-dependent and -independent apoptotic pathways after shorter exposures (2–12 hours), while decreased pro-apoptotic signals were seen at longer exposure times (24–48 hours). As indicated above, these data support the notion that RF radiation may lead cancer cells to acquire an advantage to survive and proliferate. [The Working Group noted that the statistical comparisons with respect to FACS analysis were with unexposed, not sham-exposed cells.]

[Port et al. \(2003\)](#) exposed human myeloid leukaemia cells (HL-60) to pulsed-wave RF radiation at 400 MHz (SAR not given) for 6 minutes. The electric-field strength was 50 kV/m. No effects on the number of apoptotic cells or micronuclei were found. [The Working Group noted that interpretation of these findings was difficult due to the lack of SAR values and very short exposure times.]

[Capri et al. \(2004a\)](#) exposed human peripheral blood mononuclear cells to continuous-wave or GSM-modulated RF radiation at 900 MHz

(average SAR, 70–76 mW/kg) for 1 hour per day, for 2 or 3 days. In general, no differences were detected in apoptosis – measured by means of annexin V-FITC staining – between exposed and sham-exposed cells, irrespective of whether or not the cells were treated with 2-deoxy-D-ribose, an inducer of apoptosis. In a similar study ([Capri et al., 2004b](#)), the cells were exposed intermittently (10 minutes on, 20 minutes off) to RF radiation at 1800 MHz with three different GSM-modulation schemes (SAR, 1.4 or 2 W/kg) for 44 hours. No effects on apoptosis were observed from RF radiation alone or from RF radiation combined with the apoptosis-inducing agent, 2-deoxy-D-ribose.

[Hook et al. \(2004a\)](#) reported no effects on apoptosis, detected by use of the annexin V affinity assay, in human Molt-4 lymphoblastoid leukaemia cells exposed to RF radiation at 847.74 MHz as CDMA, 835.62 MHz as FDMA, 813.56 MHz as iDEN, or 836.55 MHz as TDMA signals, for up to 24 hours. The SARs were 3.2 W/kg for CDMA and FDMA, 0.0024 or 0.024 W/kg for iDEN, and 0.0026 or 0.026 W/kg for TDMA.

[Gurisik et al. \(2006\)](#) exposed human neuroblastoma SK-N-SH cells to RF radiation at 900 MHz (GSM; SAR, 0.2 W/kg) for 2 hours. Apoptosis was measured by means of propidium iodide/YO-PRO-1 staining. No differences were detected between sham-exposed and exposed samples.

[Hirose et al. \(2006\)](#) reported no effects on apoptosis, measured by the annexin V-FITC affinity assay, or on apoptosis-related gene expression, in human glioblastoma A172 or human IMR-90 fibroblasts exposed to RF radiation at 2142.5 MHz (SAR, 0.08–0.8 W/kg), with or without W-CDMA modulation, for 24–48 hours.

[Joubert et al. \(2006\)](#) studied apoptosis in human neuroblastoma SH-SY5Y cells exposed to GSM-modulated RF radiation at 900 MHz (SAR, 0.25 W/kg) or continuous-wave RF radiation at 900 MHz (SAR of 2 W/kg) for 24 hours.

No effects on apoptosis were detected, either immediately or 24 hours after exposure, with three different techniques, *viz.* 4',6-diamino-2-phenylindole (DAPI) staining of nuclei, flow cytometry with double staining (TUNEL and propidium iodide), or measurement of caspase-3 activity by fluorometry.

[Lantow et al. \(2006c\)](#) reported no effects on apoptosis – measured with the annexin V-FITC assay – in human Mono Mac 6 cells exposed to 1800 MHz GSM-modulated RF radiation (SAR, 2.0 W/kg) for 12 hours, either alone or in combination with the apoptosis-inducing agents PMA or gliotoxin.

[Merola et al. \(2006\)](#) exposed human neuroblastoma LAN-5 cells to RF radiation at 900 MHz (GSM; SAR of 1 W/kg) for 24 or 48 hours. This exposure did not affect apoptosis, measured by an assay for caspase activation. In addition, RF-radiation did not enhance camptothecin-induced apoptosis.

[Sanchez et al. \(2006b\)](#) exposed human epidermal keratinocytes and fibroblasts to RF radiation at 900 MHz (GSM; SAR, 2 W/kg) for 48 hours. No alteration in apoptosis was detected in the annexin V/FITC affinity assay, while a very clear response was seen for UVB radiation, which was used as a positive control. In a subsequent study, [Sanchez et al. \(2007\)](#) exposed the same types of cell to RF radiation at 1800 MHz (GSM; SAR, 2 W/kg) for 2 hours. No effects on apoptosis were observed in the annexin V-FITC affinity assay.

[Chauhan et al. \(2007b\)](#) reported that apoptosis assessed by the neutral comet assay to detect DNA double-strand breaks was not affected in human TK6, HL-60, or Mono Mac 6 cells exposed to intermittent (5 minutes on, 10 minutes off) pulsed-wave RF radiation at 1900 MHz (SAR, 1, 10 W/kg) for 6 hours.

[Höytö et al. \(2008a\)](#) exposed human SH-SY5Y neuroblastoma cells to continuous-wave or GSM-modulated RF radiation at 872 MHz (SAR, 5 W/kg) for 1 or 24 hours under isothermal

conditions, with or without the apoptosis-inducing agent menadione. No direct effects of RF radiation on apoptosis, or on menadione-induced apoptosis were observed in assays for caspase-3 activity and DNA fragmentation.

Human KB oropharyngeal epidermoid carcinoma cells were exposed to RF radiation at 1.95 GHz (SAR, 3.6 mW/kg) for 1, 2, or 3 hours. The exposure caused a time-dependent increase in apoptosis (45% after 3 hours), along with a 2.5-times decrease in the expression of the genes *RAS* and *RAF1* and in the activity of the proteins *RAS* and *ERK-1/2*. The overall results showed that RF radiation can induce apoptosis via inactivation of the ras–Erk survival-signalling pathway ([Caraglia et al., 2005](#)) [the Working Group noted the lack of specific control of the temperature of the cells during the exposure periods in this study].

[The Working Group concluded that there was weak evidence that RF radiation induces apoptosis in human cells *in vitro*.]

(b) Other mammalian cells

See [Table 4.15](#)

(i) Stress response and ROS formation

Exposure of J774.16 mouse macrophages stimulated with γ -interferon and bacterial lipopolysaccharide to RF radiation at 835.62 MHz as FMCW, or to at 847.74 MHz as a CDMA signal (SAR, 0.8 W/kg) for 20–22 hours at 37 ± 0.3 °C did not alter the concentrations of intracellular oxidants (NO, glutathione disulfide), or activities of the enzymes CuZnSOD, MnSOD, catalase, or GSH-Px ([Hook et al., 2004b](#)).

[Zmysłony et al. \(2004\)](#) reported an increase in cellular ROS production in rat lymphocytes coexposed to RF radiation and iron ions. The cells were exposed to continuous-wave RF radiation at 930 MHz (SAR, 1.5 W/kg) for 5 or 15 minutes in the presence of FeCl_2 (10 $\mu\text{g/ml}$). Intracellular ROS production, measured with the fluorescent probe 2',7'-dichlorofluoresceindiacetate

Table 4.15 Effects of exposure to radiofrequency radiation in cultured mammalian cells *in vitro*

Cell type	Exposure conditions	End-points	Results	Comments	Reference
<i>Stress response and formation of reactive oxygen species</i>					
Mouse, J774.16 macrophages	835.62 MHz (FMCW) or 847.74 MHz (CDMA); SAR, 0.8 W/kg; 20–22 h; 37.0 ± 0.3°C; stimulation with IFN and bacterial LPS	Oxidative stress evaluated by oxidant and antioxidant levels, oxidative damage and NO production. Oxidation of thiols measured by accumulation of GSSG. Cellular antioxidant defenses evaluated by SOD activity (CuZnSOD and MnSOD), CAT and GSH-Px activities.	No effect on parameters indicative of oxidative stress, levels of intracellular oxidants, accumulation of GSSG, or induction of antioxidant defences in IFN/LPS-stimulated cells. No toxicity was observed.		Hook et al. (2004b)
Hamster ovary HA-1 fibroblasts, Mouse C3H10T½, Human HeLa S3 cells	835.62 MHz (FMCW), 847.74 MHz (CDMA); SAR, 0.6 or 5 W/kg; 50–60 min, or 24 h; at 37.0 ± 0.28 °C, 36.9 ± 0.18 °C and 37.1 ± 0.28 °C for FDMA-, sham-, and CDMA-exposure, respectively.	DNA-binding activity of HSF – a necessary condition for induction of a heat-shock response – monitored with a gel-shift assay.	No increase in the DNA-binding ability of HSF after any exposure tested in any of the cell lines	A 10% increase was detectable after a 1 °C temperature increase	Laszlo et al. (2005)
Mouse L929 fibroblasts Human SH-SY5Y neuroblastoma cells	872 MHz (CW or GSM); SAR, 5 W/kg; 1 h or 24 h.	Co-exposure (1 hour) with menadione (to induce ROS) or <i>t</i> -BOOH (to induce lipid peroxidation). Assessment of apoptosis (caspase3-like protease activity and DNA-fragmentation analysis) after 24 h exposure to RF	No effects of RF radiation alone. Menadione induced caspase-3 activity in L929 (not in SH-SY5Y) cells; lipid peroxidation was induced by <i>t</i> -BOOH in SH-SY5Y (not in L929) cells. Effects significant only for GSM-RF. Other end points not affected.	The positive findings may reflect effects that occur in cells sensitized by chemical stress.	Höytö et al. (2008a)
Mouse L929 fibrosarcoma cells	900 MHz (CW or GSM); SAR, 0.3 or 1 W/kg; 10 or 30 min; with/without co-exposure to 500 µM of MX.	ROS formation measured by a fluorimetric method just after the exposure and at different times until 1 h after exposure	No effect of RF radiation (with or without MX) on formation of ROS		Zeni et al. (2007b)
Wistar rat; primary cortical astrocytes	900 MHz (CW or amplitude-modulated); electric field 10V/m; 5, 10, 20 min. Electric field at the sample position: 10 V/m.	Evaluation of intracellular ROS production, and of DNA damage (comet assay).	Increased ROS levels and DNA fragmentation after a 20-min exposure to AM-RF radiation. No effects of CW	Few details of experimental procedures; no temperature control	Campisi et al. (2010)
Rat lymphocytes	930 MHz (CW); SAR 1.5 W/kg; 5 or 15 min	Intracellular ROS measured with the fluorescent probe dichlorofluorescein diacetate (DCF-DA).	No effect on ROS formation		Zmysłony et al. (2004)

Table 4.15 (continued)

Cell type	Exposure conditions	End-points	Results	Comments	Reference
Rat, age 1–2 d, primary cortical astrocytes	1763 MHz (CDMA); average SAR, 2 or 20 W/kg; 30 min or 1 h.	Assessment of expression of HSPs and activation of MAPKs	No detectable effect on expression of HSP90, HSP70, HSP27; no change in MAPK phosphorylation, ERK1/2, JNK1/2, p38; no effect on TPA-induced MAPK phosphorylation	Temperature-control at 37 ± 0.2°C	Lee et al. (2006)
Newborn rat, primary cortical neurons	1800 MHz; average SAR 2 W/kg; (5 min on, 10 min off); 24 h	Melatonin was given 4 h before exposure to RF radiation. Immunostaining and HPLC analysis of 8-OHdG in mitochondria; number of copies of mtDNA; levels of mtDNA transcripts.	RF radiation induced a significant 2-fold increase in 8-OHdG in the mitochondria of neurons, and a reduction in the copy number of mtDNA and the amount of mtRNA transcripts. The effects could be partly reversed by pre-treatment with melatonin.		Xu et al. (2010)
<i>Cell proliferation and cell cycle</i>					
Mouse C3H 10T½ cells	835.62 MHz (CW or CDMA); average SAR, 0.6 W/kg; 13 h (short exposure), up to 100 h (long-term exposure)	Cell-cycle parameters (transit of cells through G1, G2, S phase; probability of cell division) evaluated immediately after cells were exposed for 3 h, or after 100 h exposure	No changes in cell-cycle parameters after exposure to either CW or CDMA	Controlled exposure and temperature	Higashikubo et al. (2001)
Mouse pre-neoplastic CLS1 mammary epithelial cells	Nanopulse electric-field strength of 18 kV/m; repetition rate 1–1000 kHz; up to 6 h. Cells cultured in the presence EGF (10 ng/ml) and insulin (10 µg/ml) as comitogens. After exposure, cells in all treatment groups were returned to the incubator for 72 h	After exposure, cells in all treatment groups were returned to the incubator for 72 h; cell growth and viability were assessed	No effect on CLS1 cell growth or viability during the subsequent culture period of 72 h after 0.25–3 h exposure to nanopulse radiation. Prolonged exposure (4–6 h) caused a significant increase in cell proliferation.	Radar-type signal. Increase in cell proliferation associated with MAPK activation in EGF-supplemented medium.	Sylvester et al. (2005)
Mouse embryonic stem cells	1720 MHz; SAR, 1.5 W/kg (5 min on, 30 min off); 6 or 48 h	Transcript levels of cell-cycle regulatory, apoptosis-related, and neural-specific genes and proteins; changes in proliferation, apoptosis, and cytogenetic effects (quantitative RT-PCR and comet assay).	No difference in rates of cell proliferation between exposed and sham-exposed cells		Nikolova et al. (2005)

Table 4.15 (continued)

Cell type	Exposure conditions	End-points	Results	Comments	Reference
Mouse HEI-OC1 immortalized auditory hair cells	1763 MHz (CDMA); SAR, 20 W/kg; 24 or 48 h	Cell cycle (flow cytometry), DNA damage (comet assay: tail length, tail moment) were evaluated. Stress response (HSP) and gene activation were analysed with Western blotting and DNA microarray (Affymetrix full mouse genome chips, 32 000 genes)	No cell-cycle change or DNA damage. No change in expression of HSP or in phosphorylation of MAPK; minimal changes in gene expression: only 29 genes down- or upregulated; no consistent group of functional categories.		Huang et al. (2008b)
Mouse CTLL-2 cytolytic T lymphocytes	2450 MHz (CW, PW); SAR, 25 or 50 W/kg (CW) and 5 W/kg (PW); 2 h	Effects of exposure on IL-2-dependent proliferation.	Consistent and statistically significant reduction in cell proliferation at low concentrations of IL-2.	Large sample size: 24 replicates per exposure group	Cleary et al. (1996)
Chinese hamster ovary (CHO) cells	27 MHz; SAR, 5 or 25 W/kg; 2 h	Cell-cycle alterations determined by flow-cytofluorometric DNA determinations	Significant SAR-dependent changes in cell-cycle progression, with maximum change occurring 3 d after the initial exposure		Cao et al. (1995)
Chinese hamster lung fibroblasts (V79 cells)	935 MHz (CW); SAR, 0.12 W/kg; 1, 2, 3 h	Microtubule protein morphology determined by immunocytochemistry immediately after exposure; cell proliferation examined by cell counts up to 5 d after exposure	No changes after 1 or 2 h exposure. After 3 h exposure, microtubules appeared morphologically grainy, comparable to those in colchicine-treated positive controls; no consistent change in proliferation.	Only one proliferation value decreased 3 d after exposure (but not at 4 and 5 d) in cells exposed for 3 h	Pavicic & Trosic (2008)
Chinese hamster ovary (CHO) cells	2450 MHz PW; SAR, 33.8 W/kg; 2 h; simultaneous exposure to adriamycin	Evaluation of percentage of first- and second-division mitotic cells after treatment with BrdU.	Exposure did not affect changes in cell progression caused by adriamycin.		Ciaravino et al. (1991)

Table 4.15 (continued)

Cell type	Exposure conditions	End-points	Results	Comments	Reference
Chinese hamster ovary CHO-K1 cell line	2450 MHz, continuous or intermittent; SAR, 0.05–200 W/kg; 2 h	Cell survival, growth and cell cycle (flow cytometry at 0–24 h) were determined	Exposure to CW RF radiation (SAR \leq 100 W/kg) did not affect cell growth, survival, or cell-cycle distribution. At 200 W/kg, cell growth was suppressed and cell survival decreased. Exposure to intermittent RF radiation caused no significant effects. Exposures \leq 200 W/kg (continuous) or \leq 900 W/kg (intermittent) did not affect cell-cycle distribution.	Effects on proliferation due to temperature rise at SAR 50–200 W/kg	Takashima et al. (2006)
Chinese hamster V79 cells	7700 MHz, CW; power density, 30 mW/cm ² ; 15, 30, 60 min	Incorporation of [³ H]thymidine and autoradiography	Decreased [³ H]thymidine incorporation immediately after exposure. Between 4 and 24 h after exposure, incorporation returns to control values; labelling index decreased after exposure, returned to normal after 24 h.	Normal incorporation rate is recovered within one cell generation; no information on temperature control	Garaj-Vrhovac et al. (1990)
Chinese hamster V79 cells	7700 MHz, CW; power density, 0.5, 10, 30 mW/cm ² ; 10, 20, 30, 60 min	Cell survival assessed by colony-forming ability	Surviving fraction reduced in a time- and energy-dependent manner.	Exposure system kept under controlled temperature conditions at 22°C.	Garaj-Vrhovac et al. (1991)
Rat RBL-2H3 mast cells	835 MHz; estimated power density, 81 W/m ² ; for 3 \times 20 min/day for 7 days	Effects on cell proliferation, morphology and secretion	Increased [³ H]thymidine uptake and increased cell counts at days 6 and 7. Increased release of calcium	Exposure was variable across the chamber, based on temperature variation	Donnellan et al. (1997)
Transformed C6 rat glioma and normal primary glial cells (from d 17 rat embryos)	836.55 MHz (TDMA); power density 0.09, 0.9, 9 mW/cm ² ; SAR, 0.15–59 mW/kg; 24 h	Monitoring of cell growth, DNA synthesis assay ([³ H]thymidine).	No difference in growth curves and doubling times between sham-exposed and exposed cells		Stagg et al. (1997)

Table 4.15 (continued)

Cell type	Exposure conditions	End-points	Results	Comments	Reference
Rabbit lens epithelial cells	2450 MHz (CW); intensity, 0.5–20 W/m ² ; 2–8 h	Cell cycle (flow cytometry), cell viability (MTT assay); cell-cycle regulatory RNA and proteins (RT-PCR and Western blot).	Decreased number of cells in S-phase (decreased cellular replication) at exposures > 0.5 W/m ² after 8 h	Inadequate description of the exposure conditions	Yao et al. (2004)
<i>Apoptosis</i>					
Mouse-embryo primary neurons and astrocytes	1900 MHz (GSM) from a mobile phone; SAR not given; 2 h, mode “on” (exposure) or “stand-by” (sham).	Expression of apoptosis-related genes studied by array analysis. Genes showing ≥ 35% decrease or increase further studied by real time RT-PCR.	Up-regulation of <i>Pycard</i> , <i>Casp2</i> , and <i>Casp6</i> genes, both in “on” and “stand-by” modes, in neurons. <i>Pycard</i> , <i>Casp2</i> , <i>Casp6</i> , and <i>Bax</i> were upregulated in astrocytes, when cell phone in the “on” mode, but not in the “stand by” mode.	Cell phone placed over the culture dish; no dosimetry; no temperature control	Zhao et al. (2007a)
Mouse neuroblastoma N2a cells	935 MHz (GSM basic, GAM “talk”, CW); SAR, 2 W/kg; 24 h. Cells were in proliferative and differentiated states.	Apoptosis assessed – up to 48 h after exposure – by fluorescence microscopy: annexin V, caspase activation, and <i>in situ</i> end-labelling.	No differences in apoptosis levels between exposed and sham-exposed proliferating or differentiated cells		Moquet et al. (2008)
Rat-embryo primary neurons	900 MHz (CW); SAR 2 W/kg; 24 h	Apoptosis assessed by condensation of DAPI-labelled nuclei, and TUNEL assay. Caspase-3 activity assessed by fluorimetry, and apoptosis-inducing factor (AIF) by immunofluorescence.	A highly significant increase in the percentage of apoptotic cells was seen at 24 h after exposure, compared with sham-exposed cells and cells incubated at 39 °C; no increase in caspase-3 activity, but increase in AIF labelling.	Results suggest caspase-independent mitochondrial apoptosis. Increase in temperature was 2 °C during exposure. Control experiments (no RF) with neurons at 39 °C did not show an increase in apoptosis	Joubert et al. (2008)

8-OHdG, 8-hydroxy-2'-deoxyguanosine; Asc, apoptosis associated speck-like protein containing a CARD; BrdU, bromodeoxyuridine; CDMA, code-division multiple access; CAT, catalase; CW, continuous wave; d, day; ERK1/2, extracellular signal-regulated kinases; FDMA, frequency-division multiple access; FM, frequency-modulated; GSH-Px, glutathione peroxidase; GSM, Global Systems Mobile communications; GSSG, glutathione disulfide; h, hour; HSF, heat-shock transcription factor; HSP, heat-shock protein; IFN, γ -interferon; JNK1/2, c-Jun N-terminal protein kinases; LPS, lipopolysaccharide; NO, nitric oxide; RF, radiofrequency; ROS, reactive oxygen species; RT-PCR, reverse-transcriptase polymerase chain reaction; SOD, superoxide dismutase; *t*-BOOH, *tert*-butylhydroperoxide

(DCF-DA), was elevated by 16.6% and 14.6%, respectively, at these time-points. Exposure to RF radiation alone did not affect ROS production.

Exposure of mouse C3H 10T½ cells and hamster ovary HA-1 fibroblasts to RF radiation at 835.62 MHz as FMCW signal, or at 847.74 MHz as CDMA signal (SAR, 0.6 or 5 W/kg) for 1 or 24 hours did not increase the DNA-binding activity of heat-shock transcription factor ([Laszlo et al., 2005](#)).

Exposure of mouse L929 fibrosarcoma cells to continuous-wave or GSM-modulated RF radiation at 900 MHz (SAR, 0.3 or 1 W/kg) for 10 or 30 minutes, did not induce ROS formation by itself, or in combination with subtoxic concentrations of MX (3-chloro-4-(dichloromethyl)-5-hydroxy-2(5H)-furanone, a by-product of water chlorination). In this study, MX strongly induced ROS formation ([Zeni et al., 2007b](#)).

[Höytö et al. \(2008b\)](#) exposed mouse L929 cells to continuous-wave or GSM-modulated RF radiation at 872 MHz (SAR, 5 W/kg), for 1 hour or 24 hours, under isothermal conditions. To investigate possible effects of co-exposure with other agents, menadione was used to induce ROS, and *tert*-butylhydroperoxide (*t*-BOOH) was used to induce lipid peroxidation. No effects were observed after exposure to RF radiation only. Menadione-induced caspase-3 activity was significantly increased (but not in human neuroblastoma cells used in the same experiments) only by exposure to the GSM-modulated signal; *t*-BOOH-induced lipid peroxidation was not modified by RF radiation.

[Lee et al. \(2006\)](#) exposed cultures of primary astrocytes from newborn rats (aged, 1–2 days) to RF radiation at 1763 MHz as CDMA signal (average SAR, 2 or 20 W/kg) for 30 minutes or 1 hour, under temperature-controlled conditions at 37 ± 0.2 °C. RF radiation alone did not elicit a stress response and had no effect on TPA-induced MAPK phosphorylation.

[Campisi et al. \(2010\)](#) exposed cultures of primary astrocytes from newborn rats (age,

1–2 days) to continuous-wave or amplitude-modulated (50 Hz) RF radiation at 900 MHz (no SAR given; power density, 0.26 W/m^2), for 5, 10 or 20 minutes. There was an increase in ROS levels and DNA fragmentation (measured with the comet assay) after an exposure of 20 minutes to the amplitude-modulated RF radiation. With regards to the temperature of the cells during the exposure, the authors note that low-intensity RF radiation caused a minimal increase (0.03 °C) in temperature. [The publication gave few details about the experimental procedures.]

[Xu et al. \(2010\)](#) exposed primary cortical neurons from newborn rats to intermittent (5 minutes on, 10 minutes off) GSM-modulated RF radiation at 1800 MHz (average SAR, 2 W/kg) for 24 hours, and found significant increases ($P < 0.01$) in ROS production and in mitochondrial concentrations of 8-OHdG, and a reduction in copy numbers of mitochondrial DNA and mitochondrial RNA transcripts. These effects were partly reversed by treatment with melatonin 4 hours before exposure to RF radiation.

[The Working Group concluded that there was weak evidence that exposure to RF radiation activates stress response or ROS production in a variety of rodent cells *in vitro* under conditions not confounded by thermal effects.]

(ii) Cell proliferation and cell cycle

Exposure of Chinese hamster ovary (CHO) cells to pulsed-wave RF radiation at 2450 MHz (SAR, 33.8 W/kg) for 2 hours, did not affect cell-cycle progression, measured by analysis of first- and second-division mitotic cells after incorporation of bromodeoxyuridine. In the presence of adriamycin (given immediately before the exposure) RF radiation did not affect the cell-cycle progression induced by this drug ([Ciaravino et al., 1991](#)).

[Huang et al. \(2008b\)](#) did not find evidence for the induction of cellular responses, including cell-cycle distribution, DNA-damage induction,

stress response and altered gene expression, in immortalized HEI-OC1 mouse auditory hair cells exposed to RF radiation 1763 MHz (CDMA; SAR, 20 W/kg) for 24 or 48 hours. [The Working Group noted that the choice of auditory hair cells was justified by the fact that auditory cells may be exposed to radiation from mobile phones.]

In V79 Chinese hamster lung fibroblasts, microtubule morphology – analysed by use of immunocytochemical methods – appeared modified following a 3-hour exposure to continuous-wave RF radiation at 935 MHz (SAR, 0.12 W/kg). No changes were noted after exposure for 1 or 2 hours ([Pavlic & Trosic, 2008](#)).

In V79 Chinese hamster cells exposed to continuous RF radiation at 7.7 GHz (SAR not given; power density, 30 mW/cm²) for 15, 30, or 60 minutes, the incorporation of [³H]thymidine decreased immediately after exposure. At longer time intervals after exposure, the incorporation of [³H]thymidine increased and it returned to control values by 24 hours ([Garaj-Vrhovac et al., 1990b](#)). In the same cells exposed to RF radiation under the same conditions with power densities of 0.5, 10, 30 mW/cm², the surviving fraction – assessed by colony-forming ability – was reduced in a time- and energy dependent manner ([Garaj-Vrhovac et al., 1991](#)).

[Cao et al. \(1995\)](#) exposed CHO cells in different phases of the cell cycle to continuous-wave RF radiation at 27 MHz (SAR, 5 or 25 W/kg), for 2 hours. The cells were followed at sampling time-points up to 96 hours after exposure. Significant SAR-dependent changes in cell-cycle progression were observed, with the maximum change occurring at 3 days after exposure.

[Cleary et al. \(1996\)](#) exposed CTLL-2 mouse cytolytic cells to continuous-wave RF radiation at 2450 MHz (SAR, 5–50 W/kg), or to pulsed-wave RF radiation at 2450 MHz (SAR, 5 W/kg) for 2 hours. There was a decrease in cell proliferation (assessed by means of [³H]thymidine incorporation) with continuous-wave, and an increase with pulsed-wave radiation. The effects

were dependent upon the IL2 concentrations in the culture and the stage of the cell cycle.

[Donnellan et al. \(1997\)](#) exposed rat RBL-2H3 mast cells to RF radiation at 835 MHz (estimated power density, 81 W/m²) for 20 minutes, three times per day for 7 days. Increased uptake of [³H]thymidine and increased cell counts were observed at days 6 and 7, and an increase in the release of calcium was detected in the exposed group. [The exposure was variable across the exposure chamber based on temperature variations; eight samples were used for each group for analysis.]

[Stagg et al. \(1997\)](#) exposed rat primary glial cells and C6 glioma cells to RF radiation at 836.55 MHz as TDMA signal (SAR, 0.59, 5.9, 59 mW/kg) for 4 or 24 hours. A small but significant increase ($P = 0.026$) in the uptake of [³H]thymidine was detected in C6 glioma cells at 5.9 mW/kg. In the other exposure groups no effects from exposure to RF radiation were observed ([³H]thymidine uptake, cell growth).

[Higashikubo et al. \(2001\)](#) exposed mouse fibroblast (C3H 10T^{1/2}) and human glioblastoma (U87MG) cells to RF radiation at 847.74 MHz as CDMA signal or at 835.62 MHz as TDMA signal (SAR, 0.6 W/kg) for up to 100 hours. No significant effects were found on cellular replication, as measured with the bromodeoxyuridine pulse-chase flow-cytometry method.

[Takashima et al. \(2006\)](#) exposed Chinese hamster ovary CHO-K1 cells to continuous-wave RF radiation at 2450 MHz (SAR, 0.05–200 W/kg) for 2 hours, or to intermittent RF radiation at 2450 MHz (average SAR, 50 or 100 W/kg) for 2 hours. Continuous-wave RF radiation at 200 W/kg decreased cell replication and cell survival. None of the other exposures showed an effect. [The temperature of the medium increased to 44.1 °C during exposure at a SAR of 200 W/kg.]

[Yao et al. \(2004\)](#) exposed replicates of rabbit-lens epithelial cells to continuous-wave RF radiation at 2450 MHz (no SAR given; power density,

0.1–2 mW/cm², for 8 hours at 25 °C. Cell viability was significantly reduced at power densities of 0.5 mW/cm² and higher. The numbers of cells in S-phase decreased and that of cells in G₀/G₁ phase increased – both significantly – at power densities ≥ 0.5 W/m². [The Working Group had some difficulty in understanding the description of the exposure conditions in this study.]

[Nikolova et al. \(2005\)](#) exposed mouse embryonic stem cells to intermittent (5 minutes on, 30 minutes off) RF radiation at 1720 MHz (time-averaged SAR, 1.5 W/kg; during actual exposure, 12 W/kg) for 6 or 48 hours. No effects on the incorporation of bromodeoxyuridine were observed.

[Sylvester et al. \(2005\)](#) exposed mouse pre-neoplastic CL-S1 mammary epithelial cells to RF radiation as ultra-wide band pulses with an electric-field strength of 18 kV/m and a repetition rate in the range of 1–1000 kHz for up to 6 hours. No effect on CL-S1 cell growth or viability was observed after exposures of 0.25–3 hours. Exposure for 4 hours resulted in a significant increase in cell proliferation compared with untreated controls. There was no further increase at 5 or 6 hours.

[The Working Group concluded that the evidence that RF radiation has an effect on cell proliferation and cell cycle was weak.]

(iii) *Ornithine decarboxylase activity (rodent and human cells)*

Ornithine decarboxylase (ODC) is the first and rate-limiting enzyme in the polyamine biosynthesis pathway. Because polyamines are involved in the control of cell replication and differentiation, a change in cellular ODC activity is relevant to carcinogenesis. Tumour promoters such as TPA induce ODC activity, and a high level of ODC activity has been found in several premalignant conditions.

[Byus et al. \(1988\)](#) exposed Reuber H35 hepatoma, Chinese hamster ovary (CHO), and human 294 T melanoma cells to

amplitude-modulated RF radiation at 450 MHz (SAR not given; power density, 1.0 mW/cm²) for 1 hour. A 50% increase in ODC activity was observed after exposure to RF radiation alone. In addition, ODC activity induced by TPA was further enhanced by exposure to RF radiation in H35 and CHO cells.

[Litovitz et al. \(1993\)](#) reported a 90% increase in ODC activity in murine L929 fibroblasts exposed to RF radiation at 915 MHz (SAR, 2.5 W/kg; amplitude-modulated at 55, 60, or 65 Hz) for 8 hours. A continuous-wave signal did not affect cellular ODC activity. Subsequent findings from the same laboratory ([Litovitz et al., 1997](#); [Penafiel et al., 1997](#)) showed increased ODC activity in L929 cells exposed at 840 MHz (SAR, 2.5 W/kg) as a TDMA mobile-phone signal (burst-modulated at 50 Hz, with 33% duty cycle) for 2–24 hours. Also, signals with amplitude modulation at 60 Hz or 50 Hz induced ODC activity, whereas a signal modulated with speech, the signal of an analogue mobile phone, or a signal frequency modulated at 60 Hz, did not affect ODC activity. Various exposure times between 2 hours and 24 hours were used and the effect was most pronounced after exposure for 8 hours.

[Desta et al. \(2003\)](#), in an attempt to replicate the study of [Penafiel et al. \(1997\)](#), did not find any increase in ODC activity in murine L929 cells exposed to RF radiation at 835 MHz (SAR, < 1 W/kg; TDMA modulated) for 8 hours. In contrast, a decrease in ODC activity was observed at SARs of 1–5 W/kg. This decrease became statistically significant at SAR values > 6 W/kg, associated with a temperature increase of > 1 °C in the cell-culture medium.

In another replication study, [Höytö et al. \(2007\)](#) found no increase in ODC activity in L929 cells from two different sources using the same exposure system as [Penafiel et al. \(1997\)](#): a decrease in ODC activity was observed at the highest SAR used (6 W/kg). With a different exposure system and better temperature control

was used, a small increase in ODC activity was observed after 8 hours of exposure at 6 W/kg. This increase could be related to the temperature-control system, creating a temperature gradient in the cell cultures (lower temperature at the bottom of the cell culture). [Höytö et al. \(2006\)](#) reported no effects on ODC activity in L929 cells exposed to continuous-wave or GSM-modulated RF radiation at 900 MHz (SAR, 0.2 or 0.4 W/kg) for 2, 8, or 24 hours. ODC activity decreased after conventional heating (without exposure to RF radiation), consistent with the findings of [Desta et al. \(2003\)](#). Apparently, temperature differences of < 1 °C are sufficient to influence ODC activity.

[Höytö et al. \(2007b\)](#) also exposed L929 murine fibroblasts, rat C6 glioblastoma cells, human SH-SY5Y neuroblastoma cells, and rat primary astrocytes to continuous-wave and GSM-modulated RF radiation at 815 MHz (SAR, 1.5, 2.5 or 6 W/kg) for 2, 8 or 24 hours. A significant decrease in ODC activity was consistently observed in all experiments with rat primary astrocytes exposed to GSM-modulated or continuous-wave RF radiation at SARs of 1.5 or 6.0 W/kg. No effects were seen in the other cell lines.

[Billaudel et al. \(2009a\)](#) found no effects on ODC activity in L929 mouse fibroblasts exposed to RF radiation at 835 MHz, 900 MHz, or 1800 MHz as GSM or DAMPS-modulated signals (SAR, 0.5–2.5 W/kg) for 2–24 hours. The same authors reported that – consistent with the findings in murine cells – ODC activity was unaffected in human SH-SY5Y neuroblastoma cells exposed to GSM-modulated RF radiation at 1800 MHz, or DAMPS-modulated RF radiation at 835 MHz (SAR for both, 1 or 2.5 W/kg) for 8 or 24 hours ([Billaudel et al., 2009b](#)).

[The Working Group concluded that there was moderate evidence that RF radiation alters ODC activity.]

(iv) Apoptosis

Rat embryo primary neurons were exposed to continuous-wave RF radiation at 900 MHz (SAR, 2 W/Kg) for 24 hours. Because the temperature increased by 2 °C during the exposure, a control experiment at 39 °C was included (without RF radiation). Apoptosis was measured with two different methods (staining of nuclei with 4',6-diamino-2-phenylindole (DAPI) and analysis of DNA fragmentation with TUNEL-flow cytometry). With both techniques, a highly significant increase in the percentage of apoptotic cells was seen at 24 hours after exposure, compared with the sham-exposed cells and the cells incubated at 39 °C ([Joubert et al. \(2008\)](#)).

[Nikolova et al. \(2005\)](#) exposed mouse embryonic stem cell-derived neural progenitor cells to intermittent (5 minutes on, 30 minutes off) GSM-modulated RF radiation at 1710 MHz (time-averaged SAR, 1.5 W/kg; during actual exposure, 12 W/kg) for 6 or 48 hours. No effects on apoptosis or on mitochondrial membrane potential were found.

[Höytö et al. \(2008a\)](#) exposed mouse L929 cells to 872 MHz continuous-wave or GSM-modulated RF radiation (SAR of 5 W/kg) for 1 or 24 hours under isothermal conditions. Menadione-induced apoptosis (tested by measuring caspase-3 activity) was increased in cells exposed to the GSM-modulated signal, but not in cells exposed to the continuous-wave signal. No effects were seen from RF radiation in the absence of menadione. As described earlier, no effects or RF radiation on apoptosis were observed in human cells in this same study.

[Höytö et al. \(2008b\)](#) exposed mouse L929 fibroblasts that had been stimulated with fresh medium, stressed by serum deprivation, or not subjected to stimulation or stress, to continuous-wave or GSM-modulated RF radiation at 872 MHz (SAR, 5 W/kg) for 1 hour under isothermal conditions. Increased apoptosis (tested by measuring caspase-3 activity) was

seen as a response to serum deprivation, but no consistent effects of exposure to RF radiation were found.

[Joubert et al. \(2007\)](#) studied apoptosis in rat primary cortical neurons exposed to GSM-modulated RF radiation at 900 MHz (SAR, 0.25 W/kg), or continuous-wave at 900 MHz (SAR, 2 W/kg) for 24 hours. No effects on apoptosis were detected, either just after the exposure or 24 hours later, with three different techniques, *viz.* 4',6-diamino-2-phenylindole (DAPI) staining, flow cytometry with double staining (TUNEL and propidium iodide), or measurement of caspase-3 activity by fluorometry.

[Zhao et al. \(2007a\)](#) exposed cultured primary mouse embryonal neurons and astrocytes to 1900 MHz RF radiation from a working mobile phone (SAR not given) for 2 hours. The phone was placed with its antenna over the centre of the culture dish. During sham-exposures the phone was on “stand-by.” Three apoptosis-associated genes (*Pycard*, encoding the Asc protein – apoptosis-associated speck-like protein containing a caspase-recruitment domain – *Casp2*, and *Casp6*) were upregulated in neurons, both after exposure and sham-exposure. In astrocytes the upregulation was observed in exposed cells only. In addition, the astrocytes – not the neurons – showed RF radiation-dependent upregulation of the *Bax* gene. [The Working Group noted the ill-defined exposure conditions in this study; see above.]

[Moquet et al. \(2008\)](#) exposed mouse neuroblastoma N2a cells to RF radiation at 935 MHz (SAR, 2 W/kg) for 24 hours, as GSM basic (amplitude-modulated), GSM “talk,” and continuous-wave signal. No significant differences in levels of apoptosis were observed between exposed and sham-exposed cells.

[The Working Group concluded that there is weak evidence that RF radiation affects apoptosis in mammalian cells.]

4.5 Physical factors that affect interpretation of study results

4.5.1 Effects of critical RF-field parameters

(a) Modulation

There is evidence that modulation of the carrier waves of RF radiation can cause changes in biological processes that do not occur when the waves are not modulated. Examples of biological reactions to modulated RF radiation were clearly shown by [Bawin et al. \(1975\)](#), replicated by [Blackman et al. \(1979\)](#). For more examples and details, see the reviews by [Blackman \(2009\)](#) and [Juutilainen et al. \(2011\)](#).

(b) Power-intensity “windows”

Studies by [Bawin et al. \(1975, 1978\)](#) and [Blackman et al. \(1980\)](#) have characterized the power-density response in detail for the RF radiation-induced release of calcium ions from the chick brain *ex vivo*. Both groups observed regions of power density, termed “windows,” in which the release of calcium ions was exposure-dependent, separated by regions that did not respond as a function of the power density of incident radiation. Subsequent reports by [Dutta et al. \(1984, 1989\)](#) revealed similar power-density windows of induced response in nervous system-derived cultures of human and animal cells, and [Schwartz et al. \(1990\)](#) observed windows of calcium-ion release from the frog heart *ex vivo*. This phenomenon appeared to be caused by the response characteristics of the particular biological preparations. The extensive characterization of exposure–response at 50, 147 and 450 MHz (amplitude-modulated, 16 Hz) in the chick brain showed that the windows could be aligned across carrier frequencies if one used the calculated electric-field strength at the tissue surface, rather than the incident power density ([Joines & Blackman, 1980, 1981](#); [Joines et al., 1981](#); [Blackman et al., 1981, 1989](#)). See reviews by [Blackman \(2009\)](#) and [Belyaev \(2010\)](#).

4.5.2 Frequency dependence and frequency windows

Effects of RF radiation are dependent on the frequency of the carrier wave. Differences in the response of human cells to GSM-type RF radiation were observed at frequency channels of 905 and 915 MHz, where the other conditions of exposure were the same ([Belyaev et al., 2009](#); [Markovà et al., 2010](#)). Thus, it is important to know which difference in carrier frequency is acceptable to compare results from different studies.

The frequency-dependence of the effects of microwave radiation in different model systems and with different end-points measured has been reviewed ([Grundler, 1992](#); [Grundler et al., 1992](#); [Belyaev et al., 2000](#); [Belyaev, 2005, 2010](#)). The effects of resonance-type microwave radiation were observed within multiple frequency-windows at intensity values well below those at which any thermal effects had been observed. The half-width of resonances and distance between them varied in dependence on the intensity of the RF radiation. Sharper and narrower resonances, and half-widths reaching at least 2 MHz were observed at the lower intensities.

4.5.3 Polarization

Different kinds of polarization were applied in the experimental studies discussed above: linear, left-handed circular, and right-handed circular polarization. It has been shown in many studies that biological effects are dependent upon polarization ([Belyaev et al., 1992a, c, d, 1993a, b](#); [Shcheglov et al., 1997](#); [Ushakov et al., 1999, 2006a](#); [Belyaev & Kravchenko, 1994](#); [Belyaev, 2010](#)). For example, polarization should be taken into account when attempting to replicate the results of previous studies. For example, [Lai & Singh \(1996\)](#) used circular polarization, whereas linear polarization was applied in subsequent studies aimed at replicating their results, thus reducing sensitivity.

4.5.4 Dose and duration of exposure

While accumulated absorbed energy is measured as “dose” (dose rate multiplied by exposure time) in radiobiology, guidelines for exposures to RF radiation usually state power density or SAR (dose rate analogue) to define exposure. Several studies have analysed the relationship between dose and duration of exposure, with results suggesting that duration of exposure and dose may be important for cancer-relevant effects. In particular, prolonging the duration of exposure could compensate for the effects of a reduction in intensity.

[Kwee & Raskmark \(1998\)](#) analysed proliferation of human epithelial amnion cells exposed to RF radiation at 960 MHz, with SARs of 0.021, 0.21, or 2.1 mW/kg. These authors reported linear correlations between duration of exposure at 0.021 and 2.1 mW/kg and changes in cell proliferation, although no clear correlation was seen at 0.21 mW/kg.

Exposure of *E. coli* and rat thymocytes to RF radiation at power densities 0.01–1 mW/cm² resulted in significant changes in chromatin conformational state, if exposure was performed at resonance frequencies for 5–10 minutes ([Belyaev et al., 1992a, b](#); [Belyaev & Kravchenko, 1994](#)). Decreases in these effects caused by lowering the power density by an order of magnitude could be compensated for by a several-fold increase in the duration of exposure. At exposures longer than 1 hour, the same effect could be observed even at the lowest power density ([Belyaev et al., 1994](#)).

4.5.5 Background fields of extremely low frequency (ELF)

Background ELF (1–300 Hz) fields vary between laboratories. Even within the same laboratory or the same RF exposure system, variations of up to 5 µT are not uncommon. Four studies investigated the influence of background

ELF fields on the effects of exposure to RF radiation: ODC activity in L929 cells (Litovitz *et al.*, 1997), hypoxia sensitization caused by long-term repeated exposures of chick embryos (Di Carlo *et al.*, 2002), spatial learning deficits in rats induced by microwave radiation (Lai, 2004), and DNA-damage induction in rat brain cells (Lai & Singh, 2005). In these studies, the effects caused by RF radiation were significantly reduced by imposing an ELF field of up to 5 μ T.

4.5.6 Net static geomagnetic field

The static geomagnetic field (30–70 μ T, depending on the location) may alter the cellular response to RF radiation (Belyaev *et al.*, 1994; Ushakov *et al.*, 2006b). Net static magnetic fields vary by location, even within the same laboratory and with the same exposure system, due to the ferromagnetic properties of laboratory equipment. For example, the resonance effects of microwave radiation on DNA repair and chromatin conformation in *E. coli* depend on the magnitude of the net static geomagnetic field at the site of exposure (Belyaev *et al.*, 1994; Ushakov *et al.*, 2006b).

References

- Aalto S, Haarala C, Brück A *et al.* (2006). Mobile phone affects cerebral blood flow in humans. *J Cereb Blood Flow Metab*, 26: 885–890. doi:10.1038/sj.jcbfm.9600279 PMID:16495939
- Agarwal A, Desai NR, Makker K *et al.* (2009). Effects of radiofrequency electromagnetic waves (RF-EMW) from cellular phones on human ejaculated semen: an in vitro pilot study. *Fertil Steril*, 92: 1318–1325. doi:10.1016/j.fertnstert.2008.08.022 PMID:18804757
- Aitken RJ, Bennetts LE, Sawyer D *et al.* (2005). Impact of radio frequency electromagnetic radiation on DNA integrity in the male germline. *Int J Androl*, 28: 171–179. doi:10.1111/j.1365-2605.2005.00531.x PMID:15910543
- Aly MS, Ashour M, El Nahas S *et al.* (2002). Mutagenic potential of radio-frequency electromagnetic fields. *J Biol Sci*, 2: 254–258. doi:10.3923/jbs.2002.254.258
- Ammari M, Gamez C, Lecomte A *et al.* (2010). GFAP expression in the rat brain following sub-chronic exposure to a 900 MHz electromagnetic field signal. *Int J Radiat Biol*, 86: 367–375. PMID:20397841
- Ammari M, Lecomte A, Sakly M *et al.* (2008). Exposure to GSM 900 MHz electromagnetic fields affects cerebral cytochrome c oxidase activity. *Toxicology*, 250: 70–74. doi:10.1016/j.tox.2008.05.019 PMID:18585429
- Antonopoulos A, Eisenbrandt H, Obe G (1997). Effects of high-frequency electromagnetic fields on human lymphocytes in vitro. *Mutat Res*, 395: 209–214. PMID:9465932
- Baan RA (2009). Editorial: controversy related to two published papers. *Mutat Res*, 673: 1 PMID:19063993
- Balci M, Devrim E, Durak I (2007). Effects of mobile phones on oxidant/antioxidant balance in cornea and lens of rats. *Curr Eye Res*, 32: 21–25. doi:10.1080/02713680601114948 PMID:17364731
- Balode Z (1996). Assessment of radio-frequency electromagnetic radiation by the micronucleus test in bovine peripheral erythrocytes. *Sci Total Environ*, 180: 81–85. doi:10.1016/0048-9697(95)04923-1 PMID:8717319
- Balzano Q (2008). On Wolf's brief communication. *Bioelectromagnetics*, 29: 662 doi:10.1002/bem.20454 PMID:18937321
- Bandell M, Macpherson LJ, Patapoutian A (2007). From chills to chilis: mechanisms for thermosensation and chemesthesis via thermoTRPs. *Curr Opin Neurobiol*, 17: 490–497. doi:10.1016/j.conb.2007.07.014 PMID:17706410
- Baohong W, Jiliang H, Lifan J *et al.* (2005). Studying the synergistic damage effects induced by 1.8 GHz radiofrequency field radiation (RFR) with four chemical mutagens on human lymphocyte DNA using comet assay in vitro. *Mutat Res*, 578: 149–157. doi:10.1016/j.mrfmmm.2005.05.001 PMID:15935405
- Baohong W, Lifan J, Lanjuan L *et al.* (2007). Evaluating the combinative effects on human lymphocyte DNA damage induced by ultraviolet ray C plus 1.8 GHz microwaves using comet assay *in vitro*. *Toxicology*, 232: 311–316. doi:10.1016/j.tox.2007.01.019 PMID:17336440
- Barker AT, Jackson PR, Parry H *et al.* (2007). The effect of GSM and TETRA mobile handset signals on blood pressure, catechol levels and heart rate variability. *Bioelectromagnetics*, 28: 433–438. doi:10.1002/bem.20333 PMID:17486598
- Barth A, Winker R, Ponocny-Seliger E *et al.* (2008). A meta-analysis for neurobehavioural effects due to electromagnetic field exposure emitted by GSM mobile phones. *Occup Environ Med*, 65: 342–346. doi:10.1136/oem.2006.031450 PMID:17928386
- Bawin SM, Kaczmarek LK, Adey WR (1975). Effects of modulated VHF fields on the central nervous system. *Ann N Y Acad Sci*, 247: 1 Biologic Effe74–81. doi:10.1111/j.1749-6632.1975.tb35984.x PMID:1054258
- Bawin SM, Sheppard A, Adey WR (1978). Possible mechanisms of weak electromagnetic field coupling

- in brain tissue. *Bioelectrochem Bioenerg*, 5: 67–76. doi:10.1016/0302-4598(87)87008-3
- Belyaev I (2005). Non-thermal Biological Effects of Microwaves. *Microwave Review*, 11: 13–29.
- Belyaev I (2010). *Dependence of non-thermal biological effects of microwaves on physical and biological variables: implications for reproducibility and safety standards*. In: *Non-Thermal Effects And Mechanisms Of Interaction Between Electromagnetic Fields And Living Matter: a selected Summary*. Giuliani L, Soffritti M, editors. Bologna, Italy: Ramazzini Institute, European Journal of Oncology, pp. 187–218. Available at: <http://www.icems.eu/papers.htm?f=/c/a/2009/12/15/mnhj1b49kh.dtl>.
- Belyaev IY, Alipov YD, Polunin VA, Shcheglov VS (1993a). Evidence for dependence of resonant frequency of millimeter wave interaction with Escherichia coli K12 cells on haploid genome length *Electro- and Magnetobiology*, 12: 39–49.
- Belyaev IY, Alipov YD, Shcheglov VS (1992a). Chromosome DNA as a target of resonant interaction between Escherichia coli cells and low-intensity millimeter waves *Electro- and Magnetobiology*, 11(2): 97–108.
- Belyaev IY, Alipov YD, Shcheglov VS *et al.* (1994). Cooperative response of escherichia coli cells to the resonance effect of millimeter waves at super low intensity. *Electro-magnetobiology*, 13: 53–66. doi:10.3109/15368379409030698
- Belyaev IY, Hillert L, Protopopova M *et al.* (2005). 915 MHz microwaves and 50 Hz magnetic field affect chromatin conformation and 53BP1 foci in human lymphocytes from hypersensitive and healthy persons. *Bioelectromagnetics*, 26: 173–184. doi:10.1002/bem.20103 PMID:15768430
- Belyaev IY, Koch CB, Terenius O *et al.* (2006). Exposure of rat brain to 915 MHz GSM microwaves induces changes in gene expression but not double stranded DNA breaks or effects on chromatin conformation. *Bioelectromagnetics*, 27: 295–306. doi:10.1002/bem.20216 PMID:16511873
- Belyaev IY, Marková E, Hillert L *et al.* (2009). Microwaves from UMTS/GSM mobile phones induce long-lasting inhibition of 53BP1/gamma-H2AX DNA repair foci in human lymphocytes. *Bioelectromagnetics*, 30: 129–141. doi:10.1002/bem.20445 PMID:18839414
- Belyaev IY, Shcheglov VS, Alipov ED, Ushalov VD (2000). Nonthermal effects of extremely high-frequency microwaves on chromatin conformation in cells in vitro - Dependence on physical, physiological, and genetic factors. *IEEE Trans Microw Theory Tech*, 48: 2172–2179. doi:10.1109/22.884211
- Belyaev IY, Shcheglov VS, Alipov YD (1992b). Existence of selection rules on helicity during discrete transitions of the genome conformational state of E. coli cell exposed to low-level millimeter radiation. *Bioelectrochem Bioenerg*, 27: 405–411. doi:10.1016/0302-4598(92)87015-M
- Belyaev IY, Shcheglov VS, Alipov YD (1992c). Existence of selection rules on helicity during discrete transitions of the genome conformational state of E. coli cell exposed to low-level millimeter radiation. *Bioelectrochem Bioenerg*, 27: 405–411. doi:10.1016/0302-4598(92)87015-M
- Belyaev IY, Shcheglov VS, Alipov YD (1992d). *Selection rules on helicity during discrete transitions of the genome conformational state in intact and X-rayed cells of E. coli in millimeter range of electromagnetic field*. In: *Charge and Field Effects in Biosystems*. Allen MJ, Cleary SF, Sowers AE, Shillady DD, editors. Basel, Switzerland: Birkhauser, pp. 115–126.
- Belyaev IY, Shcheglov VS, Alipov YD, Radko SP (1993b). Regularities of separate and combined effects of circularly polarized millimeter waves on E. coli cells at different phases of culture growth
- Belyaev SYa & Kravchenko VG (1994). Resonance effect of low-intensity millimeter waves on the chromatin conformational state of rat thymocytes. *Z Naturforsch C*, 49: 352–358. PMID:8060460
- Benham CD, Gunthorpe MJ, Davis JB (2003). TRPV channels as temperature sensors. *Cell Calcium*, 33: 479–487. doi:10.1016/S0143-4160(03)00063-0 PMID:12765693
- Billaudel B, Taxile M, Poullietier de Gannes F *et al.* (2009b). Effects of exposure to DAMPS and GSM signals on ornithine decarboxylase (ODC) activity: II. SH-SY5Y human neuroblastoma cells. *Int J Radiat Biol*, 85: 519–522. doi:10.1080/09553000902883778 PMID:19440939
- Billaudel B, Taxile M, Ruffie G *et al.* (2009a). Effects of exposure to DAMPS and GSM signals on ornithine decarboxylase (ODC) activity: I. L-929 mouse fibroblasts. *Int J Radiat Biol*, 85: 510–518. doi:10.1080/09553000902883760 PMID:19440938
- Bisht KS, Moros EG, Straube WL *et al.* (2002). The effect of 835.62 MHz FDMA or 847.74 MHz CDMA modulated radiofrequency radiation on the induction of micronuclei in C3H 10T(1/2) cells. *Radiat Res*, 157: 506–515. doi:10.1667/0033-7587(2002)157[0506:TEOMFO]2.0.CO;2 PMID:11966316
- Blackman C (2009). Cell phone radiation: Evidence from ELF and RF studies supporting more inclusive risk identification and assessment. *Pathophysiology*, 16: 205–216. doi:10.1016/j.pathophys.2009.02.001 PMID:19264460
- Blackman CF, Benane SG, Joines WT *et al.* (1980). Calcium-ion efflux from brain tissue: power-density versus internal field-intensity dependencies at 50 MHz RF radiation. *Bioelectromagnetics*, 1: 277–283. doi:10.1002/bem.2250010304 PMID:7284026
- Blackman CF, Elder JA, Weil CW *et al.* (1979). Induction of calcium ion efflux from brain tissue by radiofrequency radiation: effects of modulation-frequency and field strength. *Radio Sci*, 14: 6S93–98. doi:10.1029/RS014i06Sp00093

- Blackman CF, Joines WT, Elder JA (1981). *Calcium-ion efflux in brain tissue by radiofrequency radiation*. In: *Biological Effects of Nonionizing Radiation*. Symposium Series Proceedings, Vol. 157. Illinger KH, editor. Washington, DC: American Chemical Society, pp. 299–314.
- Blackman CF, Kinney LS, House DE, Joines WT (1989). Multiple power-density windows and their possible origin. *Bioelectromagnetics*, 10: 115–128. doi:10.1002/bem.2250100202 PMID:2540755
- Borbély AA, Huber R, Graf T *et al.* (1999). Pulsed high-frequency electromagnetic field affects human sleep and sleep electroencephalogram. *Neurosci Lett*, 275: 207–210. doi:10.1016/S0304-3940(99)00770-3 PMID:10580711
- Bortkiewicz A, Pilacik B, Gadzicka E, Szymczak W (2002). The excretion of 6-hydroxymelatonin sulfate in healthy young men exposed to electromagnetic fields emitted by cellular phone – an experimental study. *Neuro Endocrinol Lett*, 23: Suppl 188–91. PMID:12019359
- Bourthoumieu S, Joubert V, Martin B *et al.* (2010). Cytogenetic studies in human cells exposed in vitro to GSM-900 MHz radiofrequency radiation using R-banding karyotyping. *Radiat Res*, 174: 712–718. doi:10.1667/RR2137.1 PMID:21128794
- Bourthoumieu S, Terro F, Leveque P *et al.* (2011). Aneuploidy studies in human cells exposed in vitro to GSM-900 MHz radiofrequency radiation using FISH. *Int J Radiat Biol*, 87: 400–408. doi:10.3109/09553002.2011.542543 PMID:21247240
- Braune S, Riedel A, Schulte-Mönting J, Raczek J (2002). Influence of a radiofrequency electromagnetic field on cardiovascular and hormonal parameters of the autonomic nervous system in healthy individuals. *Radiat Res*, 158: 352–356. doi:10.1667/0033-7587(2002)158[0352:IOAREF]2.0.CO;2 PMID:12175313
- Braune S, Wrocklage C, Raczek J *et al.* (1998). Resting blood pressure increase during exposure to a radiofrequency electromagnetic field. *Lancet*, 351: 1857–1858. doi:10.1016/S0140-6736(98)24025-6 PMID:9652672
- Brusick D, Albertini R, McRee D *et al.* DNA/Genetox Expert Panel (1998). Genotoxicity of radiofrequency radiation. *Environ Mol Mutagen*, 32: 1–16. doi:10.1002/(SICI)1098-2280(1998)32:1<1::AID-EM1>3.0.CO;2-Q PMID:9707093
- Busljeta I, Trosic I, Milkovic-Kraus S (2004). Erythropoietic changes in rats after 2.45 GJz nonthermal irradiation. *Int J Hyg Environ Health*, 207: 549–554. doi:10.1078/1438-4639-00326 PMID:15729835
- Buttiglione M, Roca L, Montemurro E *et al.* (2007). Radiofrequency radiation (900 MHz) induces Egr-1 gene expression and affects cell-cycle control in human neuroblastoma cells. *J Cell Physiol*, 213: 759–767. doi:10.1002/jcp.21146 PMID:17559061
- Byus CV, Kartun K, Pieper S, Adey WR (1988). Increased ornithine decarboxylase activity in cultured cells exposed to low energy modulated microwave fields and phorbol ester tumor promoters. *Cancer Res*, 48: 4222–4226. PMID:3390816
- Campisi A, Gulino M, Acquaviva R *et al.* (2010). Reactive oxygen species levels and DNA fragmentation on astrocytes in primary culture after acute exposure to low intensity microwave electromagnetic field. *Neurosci Lett*, 473: 52–55. doi:10.1016/j.neulet.2010.02.018 PMID:20156525
- Cao G, Liu L-M, Cleary SF (1995). Cell cycle alterations induced by isothermal 27 MHz radio-frequency radiation exposure. *Bioelectrochem Bioenerg*, 37: 131–140. doi:10.1016/0302-4598(95)05022-Z
- Capri M, Salvioli S, Altilia S *et al.* (2006). Age-dependent effects of in vitro radiofrequency exposure (mobile phone) on CD95+ T helper human lymphocytes. *Ann N Y Acad Sci*, 1067: 493–499. doi:10.1196/annals.1354.071 PMID:16804032
- Capri M, Scarcella E, Bianchi E *et al.* (2004b). 1800 MHz radiofrequency (mobile phones, different Global System for Mobile communication modulations) does not affect apoptosis and heat shock protein 70 level in peripheral blood mononuclear cells from young and old donors. *Int J Radiat Biol*, 80: 389–397. doi:10.1080/09553000410001702346 PMID:15362692
- Capri M, Scarcella E, Fumelli C *et al.* (2004a). In vitro exposure of human lymphocytes to 900 MHz CW and GSM modulated radiofrequency: studies of proliferation, apoptosis and mitochondrial membrane potential. *Radiat Res*, 162: 211–218. doi:10.1667/RR3209 PMID:15387149
- Caraglia M, Marra M, Mancinelli F *et al.* (2005). Electromagnetic fields at mobile phone frequency induce apoptosis and inactivation of the multi-chaperone complex in human epidermoid cancer cells. *J Cell Physiol*, 204: 539–548. doi:10.1002/jcp.20327 PMID:15754340
- Cavallo D, Tomao P, Marinaccio A *et al.* (2002). Evaluation of DNA damage in flight personnel by Comet assay. *Mutat Res*, 516: 148–152. PMID:11943620
- Chagnaud JL & Veyret B (1999). In vivo exposure of rats to GSM-modulated microwaves: flow cytometry analysis of lymphocyte subpopulations and of mitogen stimulation. *Int J Radiat Biol*, 75: 111–113. doi:10.1080/095530099140861 PMID:9972797
- Chang SK, Choi JS, Gil HW *et al.* (2005). Genotoxicity evaluation of electromagnetic fields generated by 835 MHz mobile phone frequency band. *Eur J Cancer Prev*, 14: 175–179. doi:10.1097/00008469-200504000-00014 PMID:15785322
- Chauhan V, Mariampillai A, Bellier PV *et al.* (2006a). Gene expression analysis of a human lymphoblastoma cell line exposed in vitro to an intermittent 1.9 GHz pulse-modulated radiofrequency field. *Radiat Res*, 165: 424–429. doi:10.1667/RR3531.1 PMID:16579654

- Chauhan V, Mariampillai A, Gajda GB *et al.* (2006b). Analysis of proto-oncogene and heat-shock protein gene expression in human derived cell-lines exposed in vitro to an intermittent 1.9 GHz pulse-modulated radiofrequency field. *Int J Radiat Biol*, 82: 347–354. doi:10.1080/09553000600771549 PMID:16782652
- Chauhan V, Mariampillai A, Kutzner BC *et al.* (2007b). Evaluating the biological effects of intermittent 1.9 GHz pulse-modulated radiofrequency fields in a series of human-derived cell lines. *Radiat Res*, 167: 87–93. doi:10.1667/RR0662.1 PMID:17214515
- Chauhan V, Qutob SS, Lui S *et al.* (2007a). Analysis of gene expression in two human-derived cell lines exposed in vitro to a 1.9 GHz pulse-modulated radiofrequency field. *Proteomics*, 7: 3896–3905. doi:10.1002/pmic.200700215 PMID:17902192
- Chavdoula ED, Panagopoulos DJ, Margaritis LH (2010). Comparison of biological effects between continuous and intermittent exposure to GSM-900 MHz mobile phone radiation: Detection of apoptotic cell-death features. *Mutat Res*, 700: 51–61. PMID:20472095
- Chemers NK, Gapeyev AB, Sirota NP *et al.* (2004). DNA damage in frog erythrocytes after in vitro exposure to a high peak-power pulsed electromagnetic field. *Mutat Res*, 558: 27–34. PMID:15036116
- Chemers NK, Gapeyev AB, Sirota NP *et al.* (2006). Lack of direct DNA damage in human blood leukocytes and lymphocytes after in vitro exposure to high power microwave pulses. *Bioelectromagnetics*, 27: 197–203. doi:10.1002/bem.20196 PMID:16304702
- Chia SE, Chia HP, Tan JS (2000). Prevalence of headache among handheld cellular telephone users in Singapore: a community study. *Environ Health Perspect*, 108: 1059–1062. doi:10.1289/ehp.001081059 PMID:11102297
- Ciaravino V, Meltz ML, Erwin DN (1991). Absence of a synergistic effect between moderate-power radiofrequency electromagnetic radiation and adriamycin on cell-cycle progression and sister-chromatid exchange. *Bioelectromagnetics*, 12: 289–298. doi:10.1002/bem.2250120504 PMID:1759979
- Cleary SF, Du Z, Cao G *et al.* (1996). Effect of isothermal radiofrequency radiation on cytolytic T lymphocytes. *FASEB J*, 10: 913–919. PMID:8666169
- Cleary SF, Liu LM, Merchant RE (1990). In vitro lymphocyte proliferation induced by radio-frequency electromagnetic radiation under isothermal conditions. *Bioelectromagnetics*, 11: 47–56. doi:10.1002/bem.2250110107 PMID:2346507
- Cotgreave IA (2005). Biological stress responses to radio frequency electromagnetic radiation: are mobile phones really so (heat) shocking? *Arch Biochem Biophys*, 435: 227–240. doi:10.1016/j.abb.2004.12.004 PMID:15680925
- Czerska EM, Elson EC, Davis CC *et al.* (1992). Effects of continuous and pulsed 2450 MHz radiation on spontaneous lymphoblastoid transformation of human lymphocytes in vitro. *Bioelectromagnetics*, 13: 247–259. doi:10.1002/bem.2250130402 PMID:1510735
- d'Ambrosio G, Lioi MB, Massa R, Zeni O (1995). Genotoxic effects of amplitude modulated microwaves on human lymphocytes exposed *in vitro* under controlled conditions. *Electro Magnetobiol*, 14: 157–164.
- d'Ambrosio G, Massa R, Scarfi MR, Zeni O (2002). Cytogenetic damage in human lymphocytes following GMSK phase modulated microwave exposure. *Bioelectromagnetics*, 23: 7–13. doi:10.1002/bem.93 PMID:11793401
- Dąbrowski MP, Stankiewicz W, Kubacki R *et al.* (2003). Immunotropic effects in cultured human blood mononuclear cells pre-exposed to low level 1300 MHz pulse-modulated microwave field. *Electromagn Biol Med*, 22: 1–13. doi:10.1081/JBC-120020347
- Dasdag S, Akdag MZ, Ulukaya E *et al.* (2009). Effect of mobile phone exposure on apoptotic glial cells and status of oxidative stress in rat brain. *Electromagn Biol Med*, 28: 342–354. doi:10.3109/15368370903206556 PMID:20017625
- Dasdag S, Zulkuf Akdag M, Aksen F *et al.* (2003). Whole body exposure of rats to microwaves emitted from a cell phone does not affect the testes. *Bioelectromagnetics*, 24: 182–188. doi:10.1002/bem.10083 PMID:12669301
- Dawe AS, Bodhicharla RK, Graham NS *et al.* (2009). Low-intensity microwave irradiation does not substantially alter gene expression in late larval and adult *Caenorhabditis elegans*. *Bioelectromagnetics*, 30: 602–612. PMID:19533680
- Dawe AS, Nylund R, Leszczynski D *et al.* (2008). Continuous wave and simulated GSM exposure at 1.8 W/kg and 1.8 GHz do not induce hsp16–1 heat-shock gene expression in *Caenorhabditis elegans*. *Bioelectromagnetics*, 29: 92–99. PMID:17902155
- de Gannes FP, Billaudel B, Taxile M *et al.* (2009). Effects of head-only exposure of rats to GSM-900 on blood-brain barrier permeability and neuronal degeneration. *Radiat Res*, 172: 359–367. doi:10.1667/RR1578.1 PMID:19708785
- De Iuliis GN, Newey RJ, King BV, Aitken RJ (2009). Mobile phone radiation induces reactive oxygen species production and DNA damage in human spermatozoa in vitro. *PLoS ONE*, 4: e6446 doi:10.1371/journal.pone.0006446 PMID:19649291
- Demsia G, Vlastos D, Matthopoulos DP (2004). Effect of 910 MHz electromagnetic field on rat bone marrow. *ScientificWorldJournal*, 4: Suppl 248–54. doi:10.1100/tsw.2004.178 PMID:15517102
- de Seze R, Ayoub J, Peray P *et al.* (1999). Evaluation in humans of the effects of radiocellular telephones on the circadian patterns of melatonin secretion, a chronobiological rhythm marker. *J Pineal Res*, 27: 237–242. doi:10.1111/j.1600-079X.1999.tb00621.x PMID:10551772

- Desta AB, Owen RD, Cress LW (2003). Non-thermal exposure to radiofrequency energy from digital wireless phones does not affect ornithine decarboxylase activity in L929 cells. *Radiat Res*, 160: 488–491. doi:10.1667/RR3054 PMID:12968926
- Di Carlo A, White N, Guo F *et al.* (2002). Chronic electromagnetic field exposure decreases HSP70 levels and lowers cytoprotection. *J Cell Biochem*, 84: 447–454. doi:10.1002/jcb.10036 PMID:11813250
- Diem E, Schwarz C, Adlkofer F *et al.* (2005). Non-thermal DNA breakage by mobile-phone radiation (1800 MHz) in human fibroblasts and in transformed GFSH-R17 rat granulosa cells in vitro. *Mutat Res*, 583: 178–183. PMID:15869902
- Ding G-R, Wang X-W, Li K-C *et al.* (2009). Comparison of Hsps expression after radio-frequency field exposure in three human glioma cell lines. *Biomed Environ Sci*, 22: 374–380. doi:10.1016/S0895-3988(10)60014-1 PMID:20163061
- DiTullio RA Jr, Mochan TA, Venere M *et al.* (2002). 53BP1 functions in an ATM-dependent checkpoint pathway that is constitutively activated in human cancer. *Nat Cell Biol*, 4: 998–1002. doi:10.1038/ncb892 PMID:12447382
- Dmoch A & Moszczyński P (1998). [Levels of immunoglobulin and subpopulations of T lymphocytes and NK cells in men occupationally exposed to microwave radiation in frequencies of 6–12 GHz] *Med Pr*, 49: 45–49. PMID:9587910
- Donnellan M, McKenzie DR, French PW (1997). Effects of exposure to electromagnetic radiation at 835 MHz on growth, morphology and secretory characteristics of a mast cell analogue, RBL-2H3. *Cell Biol Int*, 21: 427–439. doi:10.1006/cbir.1997.0162 PMID:9313343
- Drexler H & Schaller KH (2009). Expression of concern. *Int Arch Occup Environ Health*, 82: 143–144. doi:10.1007/s00420-008-0360-y PMID:18850107
- Dutta SK, Ghosh B, Blackman CF (1989). Radiofrequency radiation-induced calcium ion efflux enhancement from human and other neuroblastoma cells in culture. *Bioelectromagnetics*, 10: 197–202. doi:10.1002/bem.2250100208 PMID:2540756
- Dutta SK, Subramoniam A, Ghosh B, Parshad R (1984). Microwave radiation-induced calcium ion efflux from human neuroblastoma cells in culture. *Bioelectromagnetics*, 5: 71–78. doi:10.1002/bem.2250050108 PMID:6712751
- Eberhardt JL, Persson BRR, Brun AE *et al.* (2008). Blood-brain barrier permeability and nerve cell damage in rat brain 14 and 28 days after exposure to microwaves from GSM mobile phones. *Electromagn Biol Med*, 27: 215–229. doi:10.1080/15368370802344037 PMID:18821198
- Eberle P, Erdtmann-Vourliotis M, Diener S *et al.* (1996). Cell proliferation, sister-chromatid exchanges, chromosome aberrations, micronuclei and mutation rate of the HGPRT locus following the exposure of radio-frequency to electromagnetic fields (440 MHz, 900 MHz, and 1.8 GHz) on human peripheral lymphocytes. In: *Electromagnetic compatibility of biological systems*. Brinkmann K, Friedrich GV, editors. Berlin: VDE-Verlag GmbH, pp. 135–155
- Elkes E, Thuróczy G, Szabó LD (1996). Effect on the immune system of mice exposed chronically to 50 Hz amplitude-modulated 2.45 GHz microwaves. *Bioelectromagnetics*, 17: 246–248. doi:10.1002/(SICI)1521-186X(1996)17:3<246::AID-BEM11>3.0.CO;2-O PMID:8809365
- Elhag MA, Nabil GM, Attia AMMM.A. Elhag; Ghada M. Nabil; Atef M.M. Attia (2007). Effects of electromagnetic field produced by mobile phones on the oxidant and antioxidant status of rats. *Pak J Biol Sci*, 10: 4271–4274. doi:10.3923/pjbs.2007.4271.4274 PMID:19086584
- Eşmekaya MA, Seyhan N, Ömeroğlu S (2010). Pulse modulated 900 MHz radiation induces hypothyroidism and apoptosis in thyroid cells: a light, electron microscopy and immunohistochemical study. *Int J Radiat Biol*, 86: 1106–1116. PMID:20807179
- Evans CG, Chang L, Gestwicki JE (2010). Heat shock protein 70 (hsp70) as an emerging drug target. *J Med Chem*, 53: 4585–4602. doi:10.1021/jm100054f PMID:20334364
- Fernandez-Capetillo O, Chen HT, Celeste A *et al.* (2002). DNA damage-induced G₂-M checkpoint activation by histone H2AX and 53BP1. *Nat Cell Biol*, 4: 993–997. doi:10.1038/ncb884 PMID:12447390
- Fernandez-Capetillo O, Lee A, Nussenzweig M, Nussenzweig A (2004). H2AX: the histone guardian of the genome. *DNA Repair (Amst)*, 3: 959–967. doi:10.1016/j.dnarep.2004.03.024 PMID:15279782
- Ferreira AR, Knakievicz T, Pasquali MA *et al.* (2006). Ultra high frequency-electromagnetic field irradiation during pregnancy leads to an increase in erythrocytes micronuclei incidence in rat offspring. *Life Sci*, 80: 43–50. doi:10.1016/j.lfs.2006.08.018 PMID:16978664
- Fesenko EE, Makar VR, Novoselova EG, Sadovnikov VB (1999b). Microwaves and cellular immunity. I. Effect of whole body microwave irradiation on tumor necrosis factor production in mouse cells. *Bioelectrochem Bioenerg*, 49: 29–35. doi:10.1016/S0302-4598(99)00058-6 PMID:10619445
- Figueiredo ABS, Alves RN, Ramalho AT (2004). Cytogenetic analysis of the effects of 2.5 and 10.5 GHz microwaves on human lymphocytes. *Genet Mol Biol*, 27: 460–466. doi:10.1590/S1415-47572004000300024
- Finnie JW (2005). Expression of the immediate early gene, c-fos, in mouse brain after acute global system for mobile communication microwave exposure. *Pathology*, 37: 231–233. PMID:16175897
- Finnie JW, Blumbergs PC, Cai Z, Manavis J (2009b). Expression of the water channel protein, aquaporin-4, in mouse brains exposed to mobile telephone radiofrequency fields. *Pathology*, 41: 473–475. PMID:19396718

- Finnie JW, Cai Z, Blumbergs PC *et al.* (2006a). Expression of the immediate early gene, *c-fos*, in fetal brain after whole of gestation exposure of pregnant mice to global system for mobile communication microwaves. *Pathology*, 38: 333–335. PMID:16916723
- Finnie JW, Cai Z, Blumbergs PC *et al.* (2007). Stress response in mouse brain after long-term (2 year) exposure to mobile telephone radiofrequency fields using the immediate early gene, *c-fos*. *Pathology*, 39: 271–273. PMID:17454762
- Finnie JW, Cai Z, Manavis J *et al.* (2010). Microglial activation as a measure of stress in mouse brains exposed acutely (60 minutes) and long-term (2 years) to mobile telephone radiofrequency fields. *Pathology*, 42: 151–154. PMID:20085509
- Finnie JW, Chidlow G, Blumbergs PC *et al.* (2009a). Heat shock protein induction in fetal mouse brain as a measure of stress after whole of gestation exposure to mobile telephony radiofrequency fields. *Pathology*, 41: 276–279. PMID:19291540
- Foster KR & Glaser R (2007). Thermal mechanisms of interaction of radiofrequency energy with biological systems with relevance to exposure guidelines. *Health Phys*, 92: 609–620. doi:10.1097/01.HP.0000262572.64418.38 PMID:17495663
- Franzellitti S, Valbonesi P, Ciancaglini N *et al.* (2010). Transient DNA damage induced by high-frequency electromagnetic fields (GSM 1.8 GHz) in the human trophoblast HTR-8/SVneo cell line evaluated with the alkaline comet assay. *Mutat Res*, 683: 35–42. doi:10.1016/j.mrfmmm.2009.10.004 PMID:19822160
- Frey AH (1998). Headaches from cellular telephones: are they real and what are the implications? *Environ Health Perspect*, 106: 101–103. doi:10.1289/ehp.98106101 PMID:9441959
- Friedman J, Kraus S, Hauptman Y *et al.* (2007). Mechanism of short-term ERK activation by electromagnetic fields at mobile phone frequencies. *Biochem J*, 405: 559–568. doi:10.1042/BJ20061653 PMID:17456048
- Fritze K, Wiessner C, Kuster N *et al.* (1997a). Effect of global system for mobile communication microwave exposure on the genomic response of the rat brain. *Neuroscience*, 81: 627–639. PMID:9316016
- Fritzer G, Göder R, Friege L *et al.* (2007). Effects of short- and long-term pulsed radiofrequency electromagnetic fields on night sleep and cognitive functions in healthy subjects. *Bioelectromagnetics*, 28: 316–325. doi:10.1002/bem.20301 PMID:17216609
- Fucić A, Garaj-Vrhovac V, Skara M, Dimitrovic B (1992). X-rays, microwaves and vinyl chloride monomer: their clastogenic and aneugenic activity, using the micronucleus assay on human lymphocytes. *Mutat Res*, 282: 265–271. doi:10.1016/0165-7992(92)90133-3 PMID:1379689
- Gadhia PK, Shah T, Mistry A *et al.* (2003). A preliminary study to assess possible chromosomal damage among users of digital mobile phones. *Electromagn Biol Med*, 22: 149–159. doi:10.1081/JBC-120024624
- Gandhi G & Anita (2005). Genetic damage in mobile phone users: some preliminary findings. *Ind J Hum Gene.*, 11: 99–104. doi:10.4103/0971-6866.16810
- Gandhi G & Singh P (2005). Cytogenetic damage in mobile phone users: Preliminary data. *Int J Hum Genet*, 5: 259–265.
- Garaj-Vrhovac V (1999). Micronucleus assay and lymphocyte mitotic activity in risk assessment of occupational exposure to microwave radiation. *Chemosphere*, 39: 2301–2312. doi:10.1016/S0045-6535(99)00139-3 PMID:10576101
- Garaj-Vrhovac V, Fucic A, Horvat D (1990a). Comparison of chromosome aberration and micronucleus induction in human lymphocytes after occupational exposure to vinyl chloride monomer and microwave radiation. *Period Biol*, 92: 411–416.
- Garaj-Vrhovac V, Fucić A, Horvat D (1992). The correlation between the frequency of micronuclei and specific chromosome aberrations in human lymphocytes exposed to microwave radiation in vitro. *Mutat Res*, 281: 181–186. doi:10.1016/0165-7992(92)90006-4 PMID:1371840
- Garaj-Vrhovac V, Fucic A, Pevalek-Kozlina B (1993). The rate of elimination of chromosomal aberrations after accidental exposure to microwave radiation. *Bioelectrochem Bioenerg*, 30: 319–325. doi:10.1016/0302-4598(93)80091-8
- Garaj-Vrhovac V, Horvat D, Koren Z (1990). The effect of microwave radiation on the cell genome. *Mutat Res*, 243: 87–93. doi:10.1016/0165-7992(90)90028-I PMID:2304485
- Garaj-Vrhovac V, Horvat D, Koren Z (1990b). The effect of microwave radiation on the cell genome. *Mutat Res*, 243: 87–93. doi:10.1016/0165-7992(90)90028-I PMID:2304485
- Garaj-Vrhovac V, Horvat D, Koren Z (1991). The relationship between colony-forming ability, chromosome aberrations and incidence of micronuclei in V79 Chinese hamster cells exposed to microwave radiation. *Mutat Res*, 263: 143–149. doi:10.1016/0165-7992(91)90054-8 PMID:2067554
- Garaj-Vrhovac V & Orescanin V (2009). Assessment of DNA sensitivity in peripheral blood leukocytes after occupational exposure to microwave radiation: the alkaline comet assay and chromatid breakage assay. *Cell Biol Toxicol*, 25: 33–43. doi:10.1007/s10565-008-9060-3 PMID:18214694
- Garson OM, McRobert TL, Campbell LJ *et al.* (1991). A chromosomal study of workers with long-term exposure to radio-frequency radiation. *Med J Aust*, 155: 289–292. PMID:1895968
- Gatta L, Pinto R, Ubaldi V *et al.* (2003). Effects of in vivo exposure to GSM-modulated 900 MHz radiation

- on mouse peripheral lymphocytes. *Radiat Res*, 160: 600–605. doi:10.1667/RR3078 PMID:14565821
- Gerner C, Haudek V, Schandl U *et al.* (2010). Increased protein synthesis by cells exposed to a 1,800 MHz radio-frequency mobile phone electromagnetic field, detected by proteome profiling. *Int Arch Occup Environ Health*, 83: 691–702. doi:10.1007/s00420-010-0513-7 PMID:20145945
- Giedd JN (2004). Structural magnetic resonance imaging of the adolescent brain. *Ann N Y Acad Sci*, 1021: 77–85. doi:10.1196/annals.1308.009 PMID:15251877
- Glaser R (2005). Are thermoreceptors responsible for “non-thermal” effects of RF fields? *Edition Wissenschaft FGF*, 21: 2–13.
- Görlitz BD, Müller M, Ebert S *et al.* (2005). Effects of 1-week and 6-week exposure to GSM/DCS radiofrequency radiation on micronucleus formation in B6C3F1 mice. *Radiat Res*, 164: 431–439. doi:10.1667/RR3440.1 PMID:16187745
- Gos P, Eicher B, Kohli J, Heyer WD (2000). No mutagenic or recombinogenic effects of mobile phone fields at 900 MHz detected in the yeast *Saccharomyces cerevisiae*. *Bioelectromagnetics*, 21: 515–523. doi:10.1002/1521-186X(200010)21:7<515::AID-BEM5>3.0.CO;2-K PMID:11015116
- Grafström G, Nittby H, Brun A *et al.* (2008). Histopathological examinations of rat brains after long-term exposure to GSM-900 mobile phone radiation. *Brain Res Bull*, 77: 257–263. doi:10.1016/j.brainresbull.2008.08.004 PMID:18782606
- Grundler W (1992). Intensity- and frequency-dependent effects of microwaves on cell growth rates. *Bioelectrochem Bioenerg*, 27: 361–365. doi:10.1016/0302-4598(92)87010-R
- Grundler W, Kaiser F, Keilmann F, Walleczek J (1992). Mechanisms of electromagnetic interaction with cellular systems. *Naturwissenschaften*, 79: 551–559. doi:10.1007/BF01131411 PMID:1480219
- Guney M, Ozguner F, Oral B *et al.* (2007). 900 MHz radiofrequency-induced histopathologic changes and oxidative stress in rat endometrium: protection by vitamins E and C. *Toxicol Ind Health*, 23: 411–420. doi:10.1177/0748233707080906 PMID:18536493
- Guristik E, Warton K, Martin DK, Valenzuela SM (2006). An in vitro study of the effects of exposure to a GSM signal in two human cell lines: monocytic U937 and neuroblastoma SK-N-SH. *Cell Biol Int*, 30: 793–799. doi:10.1016/j.cellbi.2006.06.001 PMID:16877012
- Guy AW, Chou CK, Kunz LL *et al.* (1985). *Effects of Long-Term Low-Level Radiofrequency Radiation Exposure on Rats*. Volume 9. Summary. Seattle, WA: University Hospital, pp. 1–26. Available at: <http://www.dtic.mil/>
- Haarala C, Aalto S, Hautzel H *et al.* (2003a). Effects of a 902 MHz mobile phone on cerebral blood flow in humans: a PET study. *Neuroreport*, 14: 2019–2023. doi:10.1097/00001756-200311140-00003 PMID:14600490
- Hamblin DL & Wood AW (2002). Effects of mobile phone emissions on human brain activity and sleep variables. *Int J Radiat Biol*, 78: 659–669. doi:10.1080/09553000210132298 PMID:12194749
- Hamnerius Y, Olofsson H, Rasmuson A, Rasmuson B (1979). A negative test for mutagenic action of microwave radiation in *Drosophila melanogaster*. *Mutat Res*, 68: 217–223. doi:10.1016/0165-1218(79)90153-8 PMID:117356
- Hamnerius Y, Rasmuson A, Rasmuson B (1985). Biological effects of high-frequency electromagnetic fields on *Salmonella typhimurium* and *Drosophila melanogaster*. *Bioelectromagnetics*, 6: 405–414. doi:10.1002/bem.2250060407 PMID:3939187
- Hancock PA & Vasmatzidis I (2003). Effects of heat stress on cognitive performance: the current state of knowledge. *Int J Hyperthermia*, 19: 355–372. doi:10.1080/0265673021000054630 PMID:12745975
- Hansteen I-L, Clausen KO, Haugan V *et al.* (2009b). Cytogenetic effects of exposure to 2.3 GHz radiofrequency radiation on human lymphocytes in vitro. *Anticancer Res*, 29: 4323–4330. PMID:20032374
- Hansteen I-L, Lågeide L, Clausen KO *et al.* (2009a). Cytogenetic effects of 18.0 and 16.5 GHz microwave radiation on human lymphocytes in vitro. *Anticancer Res*, 29: 2885–2892. PMID:19661291
- Harris D & Robinson JR (1992). Drug delivery via the mucous membranes of the oral cavity. *J Pharm Sci*, 81: 1–10. doi:10.1002/jps.2600810102 PMID:1619560
- Harvey C & French PW (1999). Effects on protein kinase C and gene expression in a human mast cell line, HMC-1, following microwave exposure. *Cell Biol Int*, 23: 739–748. doi:10.1006/cbir.1999.0436 PMID:10736198
- Heikkinen P, Kosma VM, Alhonen L *et al.* (2003). Effects of mobile phone radiation on UV-induced skin tumourigenesis in ornithine decarboxylase transgenic and non-transgenic mice. *Int J Radiat Biol*, 79: 221–233. doi:10.1080/0955300031000096298 PMID:12775446
- Heikkinen P, Kosma VM, Hongisto T *et al.* (2001). Effects of mobile phone radiation on X-ray-induced tumorigenesis in mice. *Radiat Res*, 156: 775–785. doi:10.1667/0033-7587(2001)156[0775:EOMPRO]2.0.CO;2 PMID:11741502
- Heynick LN, Johnston SA, Mason PA (2003). Radio frequency electromagnetic fields: cancer, mutagenesis, and genotoxicity. *Bioelectromagnetics*, 24: Suppl 6S74–S100. doi:10.1002/bem.10162 PMID:14628308
- Higashikubo R, Ragouzis M, Moros EG *et al.* (2001). Radiofrequency electromagnetic fields do not alter the cell cycle progression of C3H 10T and U87MG cells. *Radiat Res*, 156: 786–795. doi:10.1667/0033-7587(2001)156[0786:REFDNA]2.0.CO;2 PMID:11741503

- Hintzsche H, Jastrow C, Kleine-Ostmann T *et al.* (2011). Terahertz radiation induces spindle disturbances in human-hamster hybrid cells. *Radiat Res*, doi:10.1667/RR2406.1 PMID:21388294
- Hintzsche H & Stopper H (2010). Micronucleus frequency in buccal mucosa cells of mobile phone users. *Toxicol Lett*, 193: 124–130. doi:10.1016/j.toxlet.2009.12.016 PMID:20036721
- Hirose H, Sakuma N, Kaji N *et al.* (2006). Phosphorylation and gene expression of p53 are not affected in human cells exposed to 2.1425 GHz band CW or W-CDMA modulated radiation allocated to mobile radio base stations. *Bioelectromagnetics*, 27: 494–504. doi:10.1002/bem.20238 PMID:16715525
- Hirose H, Sakuma N, Kaji N *et al.* (2007). Mobile phone base station-emitted radiation does not induce phosphorylation of Hsp27. *Bioelectromagnetics*, 28: 99–108. doi:10.1002/bem.20277 PMID:17004241
- Hocking B (1998). Brain tumours and mobile phones? *Med J Aust*, 168: 48–48. PMID:10847814
- Hocking B & Westerman R (2000). Neurological abnormalities associated with mobile phone use. *Occup Med (Lond)*, 50: 366–368. PMID:10975136
- Hook GJ, Spitz DR, Sim JE *et al.* (2004b). Evaluation of parameters of oxidative stress after in vitro exposure to FMCW- and CDMA-modulated radiofrequency radiation fields. *Radiat Res*, 162: 497–504. doi:10.1667/RR3251 PMID:15624304
- Hook GJ, Zhang P, Lagroye I *et al.* (2004a). Measurement of DNA damage and apoptosis in Molt-4 cells after in vitro exposure to radiofrequency radiation. *Radiat Res*, 161: 193–200. doi:10.1667/RR3127 PMID:14731070
- Höytö A, Juutilainen J, Naarala J (2007). Ornithine decarboxylase activity of L929 cells after exposure to continuous wave or 50 Hz modulated radiofrequency radiation—a replication study. *Bioelectromagnetics*, 28: 501–508. doi:10.1002/bem.20337 PMID:17508405
- Höytö A, Juutilainen J, Naarala J (2007b). Ornithine decarboxylase activity is affected in primary astrocytes but not in secondary cell lines exposed to 872 MHz RF radiation. *Int J Radiat Biol*, 83: 367–374. doi:10.1080/09553000701317341 PMID:17487676
- Höytö A, Luukkonen J, Juutilainen J, Naarala J (2008a). Proliferation, oxidative stress and cell death in cells exposed to 872 MHz radiofrequency radiation and oxidants. *Radiat Res*, 170: 235–243. doi:10.1667/RR1322.1 PMID:18666817
- Höytö A, Sihvonen AP, Alhonen L *et al.* (2006). Modest increase in temperature affects ODC activity in L929 cells: Low-level radiofrequency radiation does not. *Radiat Environ Biophys*, 45: 231–235. doi:10.1007/s00411-006-0053-4 PMID:16850337
- Höytö A, Sokura M, Juutilainen J, Naarala J (2008b). Radiofrequency radiation does not significantly affect ornithine decarboxylase activity, proliferation, or caspase-3 activity of fibroblasts in different physiological conditions. *Int J Radiat Biol*, 84: 727–733. doi:10.1080/09553000802345928 PMID:18821386
- Huang T-Q, Lee MS, Oh E *et al.* (2008a). Molecular responses of Jurkat T-cells to 1763 MHz radiofrequency radiation. *Int J Radiat Biol*, 84: 734–741. doi:10.1080/09553000802317760 PMID:18821387
- Huang TQ, Lee MS, Oh EH *et al.* (2008). Characterization of biological effect of 1763 MHz radiofrequency exposure on auditory hair cells. *Int J Radiat Biol*, 84: 909–915. doi:10.1080/09553000802460123 PMID:19016139
- Huang TQ, Lee MS, Oh EH *et al.* (2008b). Characterization of biological effect of 1763 MHz radiofrequency exposure on auditory hair cells. *Int J Radiat Biol*, 84: 909–915. doi:10.1080/09553000802460123 PMID:19016139
- Huber R, Graf T, Cote KA *et al.* (2000). Exposure to pulsed high-frequency electromagnetic field during waking affects human sleep EEG. *Neuroreport*, 11: 3321–3325. doi:10.1097/00001756-200010200-00012 PMID:11059895
- Huber R, Schuderer J, Graf T *et al.* (2003). Radio frequency electromagnetic field exposure in humans: Estimation of SAR distribution in the brain, effects on sleep and heart rate. *Bioelectromagnetics*, 24: 262–276. doi:10.1002/bem.10103 PMID:12696086
- Huber R, Treyer V, Borbély AA *et al.* (2002). Electromagnetic fields, such as those from mobile phones, alter regional cerebral blood flow and sleep and waking EEG. *J Sleep Res*, 11: 289–295. doi:10.1046/j.1365-2869.2002.00314.x PMID:12464096
- Huber R, Treyer V, Schuderer J *et al.* (2005). Exposure to pulse-modulated radio frequency electromagnetic fields affects regional cerebral blood flow. *Eur J Neurosci*, 21: 1000–1006. doi:10.1111/j.1460-9568.2005.03929.x PMID:15787706
- Hung CS, Anderson C, Horne JA, McEvoy P (2007). Mobile phone ‘talk-mode’ signal delays EEG-determined sleep onset. *Neurosci Lett*, 421: 82–86. doi:10.1016/j.neulet.2007.05.027 PMID:17548154
- ICNIRP; International Commission on Non-Ionizing Radiation Protection (2009). *Exposure to high frequency electromagnetic fields, biological effects and health consequences (100 kHz-300 GHz)*. la Vecchia C, Matthes R, Ziegelberger G *et al.*, editors. International Commission on Non-Ionizing Radiation Protection.
- IEGMP (2000). *Mobile Phones and Health. Report of an Independent Expert Group on Mobile Phones*. Available at: <http://www.iegmp.org.uk>.
- Ilhan A, Gurel A, Armutcu F *et al.* (2004). Ginkgo biloba prevents mobile phone-induced oxidative stress in rat brain. *Clin Chim Acta*, 340: 153–162. doi:10.1016/j.cccn.2003.10.012 PMID:14734207
- Imge EB, Kiliçoğlu B, Devrim E *et al.* (2010). Effects of mobile phone use on brain tissue from the rat and a possible protective role of vitamin C - a preliminary study. *Int J Radiat Biol*, 86: 1044–1049. doi:10.3109/09553002.2010.501838 PMID:20698742

- Irmak MK, Fadilloğlu E, Güleç M *et al.* (2002). Effects of electromagnetic radiation from a cellular telephone on the oxidant and antioxidant levels in rabbits. *Cell Biochem Funct*, 20: 279–283. doi:10.1002/cbf.976 PMID:12415560
- IRPA; International Non-Ionizing Radiation Committee of the International Radiation Protection Association (1988). Guidelines on limits of exposure to radiofrequency electromagnetic fields in the frequency range from 100 kHz to 300 GHz. *Health Phys*, 54: 115–123. PMID:3335439
- Ismail IH, Wadhra TI, Hammarsten O (2007). An optimized method for detecting gamma-H2AX in blood cells reveals a significant interindividual variation in the gamma-H2AX response among humans. *Nucleic Acids Res*, 35: e36 doi:10.1093/nar/gkl1169 PMID:17284459
- Jarupat S, Kawabata A, Tokura H, Borkiewicz A (2003). Effects of 1900 MHz electromagnetic field emitted from cellular phone on nocturnal melatonin secretion. *J Physiol Anthropol*, 22: 61–63. doi:10.2114/jpa.22.61
- Jauchem JR (2008). Effects of low-level radio-frequency (3kHz to 300GHz) energy on human cardiovascular, reproductive, immune, and other systems: a review of the recent literature. *Int J Hyg Environ Health*, 211: 1–29. doi:10.1016/j.ijheh.2007.05.001 PMID:17692567
- Joines WT & Blackman CF (1980). Power density, field intensity, and carrier frequency determinants of RF-energy-induced calcium-ion efflux from brain tissue. *Bioelectromagnetics*, 1: 271–275. doi:10.1002/bem.2250010303 PMID:7284025
- Joines WT & Blackman CF (1981). Equalizing the electric field intensity within chick brain immersed in buffer solution at different carrier frequencies. *Bioelectromagnetics*, 2: 411–413. doi:10.1002/bem.2250020413 PMID:7326063
- Joines WT, Blackman CF, Hollis MA (1981). Broadening of the RF power-density window for calcium-ion efflux from brain tissue. *IEEE Trans Biomed Eng*, 28: 568–573. doi:10.1109/TBME.1981.324829 PMID:7262896
- Joubert V, Bourthoumieu S, Leveque P, Yardin C (2008). Apoptosis is induced by radiofrequency fields through the caspase-independent mitochondrial pathway in cortical neurons. *Radiat Res*, 169: 38–45. doi:10.1667/RR1077.1 PMID:18159956
- Joubert V, Leveque P, Cueille M *et al.* (2007). No apoptosis is induced in rat cortical neurons exposed to GSM phone fields. *Bioelectromagnetics*, 28: 115–121. doi:10.1002/bem.20274 PMID:17004238
- Joubert V, Leveque P, Rametti A *et al.* (2006). Microwave exposure of neuronal cells in vitro: Study of apoptosis. *Int J Radiat Biol*, 82: 267–275. doi:10.1080/09553000600649232 PMID:16690594
- Juutilainen J, Heikkinen P, Soikkeli H, Mäki-Paakkanen J (2007). Micronucleus frequency in erythrocytes of mice after long-term exposure to radiofrequency radiation. *Int J Radiat Biol*, 83: 213–220. doi:10.1080/09553000601169800 PMID:17575948
- Juutilainen J, Höytö A, Kumlin T, Naarala J (2011). Review of possible modulation-dependent biological effects of radiofrequency fields. *Bioelectromagnetics*, 32: 511–534. doi:10.1002/bem.20652 PMID:21480304
- Karinen A, Heinävaara S, Nylund R, Leszczynski D (2008). Mobile phone radiation might alter protein expression in human skin. *BMC Genomics*, 9: 77–81. PMID:18267023
- Kerbacher JJ, Meltz ML, Erwin DN (1990). Influence of radiofrequency radiation on chromosome aberrations in CHO cells and its interaction with DNA-damaging agents. *Radiat Res*, 123: 311–319. doi:10.2307/3577738 PMID:2120738
- Kesari KK, Behari J, Kumar S (2010). Mutagenic response of 2.45 GHz radiation exposure on rat brain. *Int J Radiat Biol*, 86: 334–343. doi:10.3109/09553000903564059 PMID:20353343
- Kim JY, Hong SY, Lee YM *et al.* (2008a). *In vitro* assessment of clastogenicity of mobile-phone radiation (835 MHz) using the alkaline comet assay and chromosomal aberration test. *Environ Toxicol*, 23: 319–327. doi:10.1002/tox.20347 PMID:18214898
- Kim K-B, Byun H-O, Han N-K *et al.* (2010). Two-dimensional electrophoretic analysis of radiofrequency radiation-exposed MCF7 breast cancer cells. *J Radiat Res (Tokyo)*, 51: 205–213. doi:10.1269/jrr.09030 PMID:20339255
- Kim TH, Huang TQ, Jang JJ *et al.* (2008b). Local exposure of 849 MHz and 1763 MHz radiofrequency radiation to mouse heads does not induce cell death or cell proliferation in brain. *Exp Mol Med*, 40: 294–303. PMID:18587267
- Kimata H (2005). Microwave radiation from cellular phones increases allergen-specific IgE production. *Allergy*, 60: 838–839. doi:10.1111/j.1398-9995.2005.00802.x PMID:15876318
- Kolomytseva MP, Gapeev AB, Sadovnikov VB, Chemeris NK (2002). [Suppression of nonspecific resistance of the body under the effect of extremely high frequency electromagnetic radiation of low intensity] *Biofizika*, 47: 71–77. PMID:11855293
- Komatsubara Y, Hirose H, Sakurai T *et al.* (2005). Effect of high-frequency electromagnetic fields with a wide range of SARs on chromosomal aberrations in murine m5S cells. *Mutat Res*, 587: 114–119. PMID:16202641
- Korenstein-Ilan A, Barbul A, Hasin P *et al.* (2008). Terahertz radiation increases genomic instability in human lymphocytes. *Radiat Res*, 170: 224–234. doi:10.1667/RR0944.1 PMID:18666810
- Koyama S, Isozumi Y, Suzuki Y *et al.* (2004). Effects of 2.45-GHz electromagnetic fields with a wide range of SARs on micronucleus formation in CHO-K1 cells. *ScientificWorldJournal*, 4: Suppl 229–40. doi:10.1100/tsw.2004.176 PMID:15517100

- Koyama S, Nakahara T, Wake K *et al.* (2003). Effects of high frequency electromagnetic fields on micronucleus formation in CHO-K1 cells. *Mutat Res*, 541: 81–89. PMID:14568297
- Koyama S, Takashima Y, Sakurai T *et al.* (2007). Effects of 2.45 GHz electromagnetic fields with a wide range of SARs on bacterial and HPRT gene mutations. *J Radiat Res (Tokyo)*, 48: 69–75. doi:10.1269/jrr.06085 PMID:17179647
- Krewski D, Glickman BW, Habash RWY *et al.* (2007). Recent advances in research on radiofrequency fields and health: 2001–2003. *J Toxicol Environ Health B Crit Rev*, 10: 287–318. PMID:17620203
- Kumar S, Kesari KK, Behari J (2010). Evaluation of genotoxic effects in male Wistar rats following microwave exposure. *Indian J Exp Biol*, 48: 586–592. PMID:20882761
- Kuster N (2008). Comments on the brief communication ‘Security considerations in blinded exposure experiments using electromagnetic waves’ by Christian Wolf. *Bioelectromagnetics*, 29: 660–661. doi:10.1002/bem.20450 PMID:18844230
- Kwee S & Raskmark P (1998). Changes in cell proliferation due to environmental non-ionizing radiation. 2. Microwave radiation. *Bioelectrochem Bioenerg*, 44: 251–255. doi:10.1016/S0302-4598(97)00095-0
- Kwon MS & Hämäläinen H (2011). Effects of mobile phone electromagnetic fields: critical evaluation of behavioral and neurophysiological studies. *Bioelectromagnetics*, 32: 253–272. doi:10.1002/bem.20635 PMID:21452356
- Lagroye I, Anane R, Wettring BA *et al.* (2004a). Measurement of DNA damage after acute exposure to pulsed-wave 2450 MHz microwaves in rat brain cells by two alkaline comet assay methods. *Int J Radiat Biol*, 80: 11–20. doi:10.1080/09553000310001642911 PMID:14761846
- Lagroye I, Hook GJ, Wettring BA *et al.* (2004b). Measurements of alkali-labile DNA damage and protein-DNA crosslinks after 2450 MHz microwave and low-dose gamma irradiation in vitro. *Radiat Res*, 161: 201–214. doi:10.1667/RR3122 PMID:14731069
- Lai H (2004). Interaction of microwaves and a temporally incoherent magnetic field on spatial learning in the rat. *Physiol Behav*, 82: 785–789. PMID:15451642
- Lai H (2007). Evidence for genotoxic effects (RFR and ELF genotoxicity). Bioinitiative Working Group. *Section*, 6: 1–43.
- Lai H & Singh NP (1995). Acute low-intensity microwave exposure increases DNA single-strand breaks in rat brain cells. *Bioelectromagnetics*, 16: 207–210. doi:10.1002/bem.2250160309 PMID:7677797
- Lai H & Singh NP (1996). Single- and double-strand DNA breaks in rat brain cells after acute exposure to radiofrequency electromagnetic radiation. *Int J Radiat Biol*, 69: 513–521. doi:10.1080/095530096145814 PMID:8627134
- Lai H & Singh NP (1997). Melatonin and a spin-trap compound block radiofrequency electromagnetic radiation-induced DNA strand breaks in rat brain cells. *Bioelectromagnetics*, 18: 446–454. doi:10.1002/(SICI)1521-186X(1997)18:6<446::AID-BEM7>3.0.CO;2-2 PMID:9261542
- Lai H & Singh NP (2005). Interaction of microwaves and a temporally incoherent magnetic field on single and double DNA strand breaks in rat brain cells. *Electromagn Biol Med*, 24: 23–29. doi:10.1081/JBC-200055046
- Lakatta EG (2002). Age-associated cardiovascular changes in health: impact on cardiovascular disease in older persons. *Heart Fail Rev*, 7: 29–49. doi:10.1023/A:1013797722156 PMID:11790921
- Lalić H, Lekić A, Radošević-Stasić B (2001). Comparison of chromosome aberrations in peripheral blood lymphocytes from people occupationally exposed to ionizing and radiofrequency radiation. *Acta Med Okayama*, 55: 117–127. PMID:11332198
- Lantow M, Lupke M, Frahm J *et al.* (2006b). ROS release and Hsp70 expression after exposure to 1,800 MHz radiofrequency electromagnetic fields in primary human monocytes and lymphocytes. *Radiat Environ Biophys*, 45: 55–62. doi:10.1007/s00411-006-0038-3 PMID:16552570
- Lantow M, Schuderer J, Hartwig C, Simkó M (2006a). Free radical release and HSP70 expression in two human immune-relevant cell lines after exposure to 1800 MHz radiofrequency radiation. *Radiat Res*, 165: 88–94. doi:10.1667/RR3476.1 PMID:16392966
- Lantow M, Viergutz T, Weiss DG, Simkó M (2006c). Comparative study of cell cycle kinetics and induction of apoptosis or necrosis after exposure of human Mono Mac 6 cells to radiofrequency radiation. *Radiat Res*, 166: 539–543. doi:10.1667/RR3601.1 PMID:16953672
- Laszlo A, Moros EG, Davidson T *et al.* (2005). The heat-shock factor is not activated in mammalian cells exposed to cellular phone frequency microwaves. *Radiat Res*, 164: 163–172. doi:10.1667/RR3406 PMID:16038587
- Lee HJ, Pack JK, Kim TH *et al.* (2010). The lack of histological changes of CDMA cellular phone-based radio frequency on rat testis. *Bioelectromagnetics*, 31: 528–534. PMID:20607737
- Lee J-S, Huang T-Q, Kim T-H *et al.* (2006). Radiofrequency radiation does not induce stress response in human T-lymphocytes and rat primary astrocytes. *Bioelectromagnetics*, 27: 578–588. doi:10.1002/bem.20235 PMID:16838270
- Lee JS, Huang TQ, Lee JJ *et al.* (2005). Subchronic exposure of hsp70.1-deficient mice to radiofrequency radiation. *Int J Radiat Biol*, 81: 781–792. PMID:16449085
- Lee KS, Choi JS, Hong SY *et al.* (2008). Mobile phone electromagnetic radiation activates MAPK signalling and regulates viability in *Drosophila*. *Bioelectromagnetics*, 29: 371–379. PMID:18286519

- Lerchl A & Wilhelm AFX (2010). Critical comments on DNA breakage by mobile-phone electromagnetic fields [Diem *et al.*, *Mutat. Res.* 583 (2005) 178–183]. *Mutat Res*, 697: 60–65. PMID:20100594
- Leszczynski D, Joenväärä S, Reivinen J, Kuokka R (2002). Non-thermal activation of the hsp27/p38MAPK stress pathway by mobile phone radiation in human endothelial cells: molecular mechanism for cancer and blood-brain barrier-related effects. *Differentiation*, 70: 120–129. doi:10.1046/j.1432-0436.2002.700207.x PMID:12076339
- Li H-W, Yao K, Jin H-Y *et al.* (2007). Proteomic analysis of human lens epithelial cells exposed to microwaves. *Jpn J Ophthalmol*, 51: 412–416. doi:10.1007/s10384-007-0483-9 PMID:18158590
- Li JR, Chou CK, McDougall JA *et al.* (1999). TP53 tumor suppressor protein in normal human fibroblasts does not respond to 837 MHz microwave exposure. *Radiat Res*, 151: 710–716. doi:10.2307/3580210 PMID:10360791
- Li L, Bisht KS, LaGroye I *et al.* (2001). Measurement of DNA damage in mammalian cells exposed in vitro to radiofrequency fields at SARs of 3–5 W/kg. *Radiat Res*, 156: 328–332. doi:10.1667/0033-7587(2001)156[0328:MODD IM]2.0.CO;2 PMID:11500143
- Lim HB, Cook GG, Barker AT, Coulton LA (2005). Effect of 900 MHz electromagnetic fields on nonthermal induction of heat-shock proteins in human leukocytes. *Radiat Res*, 163: 45–52. doi:10.1667/RR3264 PMID:15606306
- Litovitz TA, Krause D, Penafiel M *et al.* (1993). The role of coherence time in the effect of microwaves on ornithine decarboxylase activity. *Bioelectromagnetics*, 14: 395–403. doi:10.1002/bem.2250140502 PMID:8285913
- Litovitz TA, Penafiel LM, Farrel JM *et al.* (1997). Bioeffects induced by exposure to microwaves are mitigated by superposition of ELF noise. *Bioelectromagnetics*, 18: 422–430. doi:10.1002/(SICI)1521-186X(1997)18:6<422::AID-BEM4>3.0.CO;2-4 PMID:9261539
- Lixia S, Yao K, Kaijun W *et al.* (2006). Effects of 1.8 GHz radiofrequency field on DNA damage and expression of heat shock protein 70 in human lens epithelial cells. *Mutat Res*, 602: 135–142. doi:10.1016/j.mrfmmm.2006.08.010 PMID:17011595
- Loughran SP, Wood AW, Barton JM *et al.* (2005). The effect of electromagnetic fields emitted by mobile phones on human sleep. *Neuroreport*, 16: 1973–1976. doi:10.1097/01.wnr.0000186593.79705.3c PMID:16272890
- Lowden A, Akerstedt T, Ingre M *et al.* (2011). Sleep after mobile phone exposure in subjects with mobile phone-related symptoms. *Bioelectromagnetics*, 32: 4–14. doi:10.1002/bem.20609 PMID:20857453
- Lushnikov KV, Gapeev AB, Sadovnikov VB, Cheremis NK (2001). [Effect of extremely high frequency electromagnetic radiation of low intensity on parameters of humoral immunity in healthy mice.] *Biofizika*, 46: 753–760. PMID:11558390
- Luukkonen J, Hakulinen P, Mäki-Paakkanen J *et al.* (2009). Enhancement of chemically induced reactive oxygen species production and DNA damage in human SH-SY5Y neuroblastoma cells by 872 MHz radiofrequency radiation. *Mutat Res*, 662: 54–58. doi:10.1016/j.mrfmmm.2008.12.005 PMID:19135463
- Luukkonen J, Juutilainen J, Naarala J (2010). Combined effects of 872 MHz radiofrequency radiation and ferrous chloride on reactive oxygen species production and DNA damage in human SH-SY5Y neuroblastoma cells. *Bioelectromagnetics*, 31: 417–424. PMID:20564172
- Maes A, Collier M, Slaets D, Verschaeve L (1995). Cytogenetic effects of microwaves from Mobile communication frequencies (954 MHz). *Electro Magnetobiol.*, 14: 91–98.
- Maes A, Collier M, Slaets D, Verschaeve L (1996). 954 MHz microwaves enhance the mutagenic properties of mitomycin C. *Environ Mol Mutagen*, 28: 26–30. doi:10.1002/(SICI)1098-2280(1996)28:1<26::AID-EM6>3.0.CO;2-C PMID:8698043
- Maes A, Collier M, Van Gorp U *et al.* (1997). Cytogenetic effects of 935.2 MHz (GSM) microwaves alone and in combination with mitomycin C. *Mutat Res*, 393: 151–156. PMID:9357572
- Maes A, Collier M, Verschaeve L (2000). Cytogenetic investigations on microwaves emitted by a 455.7 MHz car phone. *Folia Biol (Praha)*, 46: 175–180. PMID:11055795
- Maes A, Collier M, Verschaeve L (2001). Cytogenetic effects of 900 MHz (GSM) microwaves on human lymphocytes. *Bioelectromagnetics*, 22: 91–96. doi:10.1002/1521-186X(200102)22:2<91::AID-BEM1011>3.0.CO;2-W PMID:11180254
- Maes A, Van Gorp U, Verschaeve L (2006). Cytogenetic investigation of subjects professionally exposed to radiofrequency radiation. *Mutagenesis*, 21: 139–142. doi:10.1093/mutage/gel008 PMID:16481348
- Maes A, Verschaeve L, Arroyo A *et al.* (1993). In vitro cytogenetic effects of 2450 MHz waves on human peripheral blood lymphocytes. *Bioelectromagnetics*, 14: 495–501. doi:10.1002/bem.2250140602 PMID:8297394
- Mailankot M, Kunnath AP, Jayalekshmi H *et al.* (2009). Radio frequency electromagnetic radiation (RF-EMR) from GSM (0.9/1.8GHz) mobile phones induces oxidative stress and reduces sperm motility in rats. *Clinics (Sao Paulo)*, 64: 561–565. PMID:19578660
- Malyapa RS, Ahern EW, Bi C *et al.* (1998). DNA damage in rat brain cells after in vivo exposure to 2450 MHz electromagnetic radiation and various methods of euthanasia. *Radiat Res*, 149: 637–645. doi:10.2307/3579911 PMID:9611103
- Malyapa RS, Ahern EW, Straube WL *et al.* (1997a). Measurement of DNA damage after exposure to 2450 MHz electromagnetic radiation. *Radiat Res*, 148: 608–617. doi:10.2307/3579737 PMID:9399707

- Malyapa RS, Ahern EW, Straube WL *et al.* (1997b). Measurement of DNA damage after exposure to electromagnetic radiation in the cellular phone communication frequency band (835.62 and 847.74 MHz). *Radiat Res*, 148: 618–627. doi:10.2307/3579738 PMID:9399708
- Mann K & Röschke J (1996). Effects of pulsed high-frequency electromagnetic fields on human sleep. *Neuropsychobiology*, 33: 41–47. doi:10.1159/000119247 PMID:8821374
- Mann K, Wagner P, Brunn G *et al.* (1998). Effects of pulsed high-frequency electromagnetic fields on the neuroendocrine system. *Neuroendocrinology*, 67: 139–144. doi:10.1159/000054308 PMID:9508044
- Manti L, Braselmann H, Calabrese ML *et al.* (2008). Effects of modulated microwave radiation at cellular telephone frequency (1.95 GHz) on X-ray-induced chromosome aberrations in human lymphocytes in vitro. *Radiat Res*, 169: 575–583. doi:10.1667/RR1044.1 PMID:18439037
- Marec F, Ondráček J, Brunnhofer V (1985). The effect of repeated microwave irradiation on the frequency of sex-linked recessive lethal mutations in *Drosophila melanogaster*. *Mutat Res*, 157: 163–167. doi:10.1016/0165-1218(85)90112-0 PMID:3927161
- Marinelli F, La Sala D, Ciccio G *et al.* (2004). Exposure to 900 MHz electromagnetic field induces an imbalance between pro-apoptotic and pro-survival signals in T-lymphoblastoid leukemia CCRF-CEM cells. *J Cell Physiol*, 198: 479–480. doi:10.1002/jcp.10483
- Marková E, Hillert L, Malmgren L *et al.* (2005). Microwaves from GSM mobile telephones affect 53BP1 and gamma-H2AX foci in human lymphocytes from hypersensitive and healthy persons. *Environ Health Perspect*, 113: 1172–1177. doi:10.1289/ehp.7561 PMID:16140623
- Marková E, Malmgren LOG, Belyaev IY (2010). Microwaves from mobile phones inhibit 53BP1 focus formation in human stem cells more strongly than in differentiated cells: possible mechanistic link to cancer risk. *Environ Health Perspect*, 118: 394–399.
- Mashevich M, Folkman D, Kesar A *et al.* (2003). Exposure of human peripheral blood lymphocytes to electromagnetic fields associated with cellular phones leads to chromosomal instability. *Bioelectromagnetics*, 24: 82–90. doi:10.1002/bem.10086 PMID:12524674
- Maskey D, Kim M, Aryal B *et al.* (2010). Effect of 835 MHz radiofrequency radiation exposure on calcium binding proteins in the hippocampus of the mouse brain. *Brain Res*, 1313: 232–241. PMID:19968972
- Masuda H, Sanchez S, Dulou PE *et al.* (2006). Effect of GSM-900 and –1800 signals on the skin of hairless rats. I: 2-hour acute exposures. *Int J Radiat Biol*, 82: 669–674. PMID:17050479
- Masuda H, Ushiyama A, Takahashi M *et al.* (2009). Effects of 915 MHz electromagnetic-field radiation in TEM cell on the blood-brain barrier and neurons in the rat brain. *Radiat Res*, 172: 66–73. doi:10.1667/RR1542.1 PMID:19580508
- Mazor R, Korenstein-Ilan A, Barbul A *et al.* (2008). Increased levels of numerical chromosome aberrations after in vitro exposure of human peripheral blood lymphocytes to radiofrequency electromagnetic fields for 72 hours. *Radiat Res*, 169: 28–37. doi:10.1667/RR0872.1 PMID:18159938
- McNamee JP, Bellier PV, Gajda GB *et al.* (2002a). DNA damage and micronucleus induction in human leukocytes after acute in vitro exposure to a 1.9 GHz continuous-wave radiofrequency field. *Radiat Res*, 158: 523–533. doi:10.1667/0033-7587(2002)158[0523:DDAM II]2.0.CO;2 PMID:12236820
- McNamee JP, Bellier PV, Gajda GB *et al.* (2003). No evidence for genotoxic effects from 24 h exposure of human leukocytes to 1.9 GHz radiofrequency fields. *Radiat Res*, 159: 693–697. doi:10.1667/0033-7587(2003)159[0693:NEFG EF]2.0.CO;2 PMID:12710882
- McNamee JP & Chauhan V (2009). Radiofrequency radiation and gene/protein expression: a review. *Radiat Res*, 172: 265–287. doi:10.1667/RR1726.1 PMID:19708776
- McQuade JMS, Merritt JH, Miller SA *et al.* (2009). Radiofrequency-radiation exposure does not induce detectable leakage of albumin across the blood-brain barrier. *Radiat Res*, 171: 615–621. doi:10.1667/RR1507.1 PMID:19580497
- Meltz ML (2003). Radiofrequency exposure and mammalian cell toxicity, genotoxicity, and transformation. *Bioelectromagnetics*, 24: Suppl 6S196–S213. doi:10.1002/bem.10176 PMID:14628315
- Meltz ML, Eagan P, Erwin DN (1989). Absence of mutagenic interaction between microwaves and mitomycin C in mammalian cells. *Environ Mol Mutagen*, 13: 294–303. doi:10.1002/em.2850130404 PMID:2500336
- Meltz ML, Eagan P, Erwin DN (1990). Proflavin and microwave radiation: absence of a mutagenic interaction. *Bioelectromagnetics*, 11: 149–157. doi:10.1002/bem.2250110206 PMID:2242050
- Meral I, Mert H, Mert N *et al.* (2007). Effects of 900 MHz electromagnetic field emitted from cellular phone on brain oxidative stress and some vitamin levels of guinea pigs. *Brain Res*, 1169: 120–124. doi:10.1016/j.brainres.2007.07.015 PMID:17674954
- Merola P, Marino C, Lovisolo GA *et al.* (2006). Proliferation and apoptosis in a neuroblastoma cell line exposed to 900 MHz modulated radiofrequency field. *Bioelectromagnetics*, 27: 164–171. doi:10.1002/bem.20201 PMID:16437547
- Michalska J, Motykiewicz G, Kalinowska E, Chorazy M (1998). Bleomycin sensitivity test in the exposed and reference human populations. *Mutat Res*, 418: 43–48. doi:10.1016/S1383-5718(98)00110-7 PMID:9748495
- Mittler S (1976). Failure of 2- and 10-meter radio waves to induce genetic damage in *Drosophila melanogaster*. *Environ Res*, 11: 326–330. doi:10.1016/0013-9351(76)90094-3 PMID:820551

- Mittler S (1977). Failure of chronic exposure to nonthermal FM radio waves to mutate *Drosophila*. *J Hered*, 68: 257–258. PMID:925338
- Miyakoshi J, Takemasa K, Takashima Y *et al.* (2005). Effects of exposure to a 1950 MHz radio frequency field on expression of Hsp70 and Hsp27 in human glioma cells. *Bioelectromagnetics*, 26: 251–257. doi:10.1002/bem.20077 PMID:15832340
- Miyakoshi J, Yoshida M, Tarusawa Y *et al.* (2002). Effects of high- frequency electromagnetic fields on DNA strand breaks using comet assay method. *Electr Eng Jpn*, 141: 9–15. doi:10.1002/eej.10075
- Moquet J, Ainsbury E, Bouffler S, Lloyd D (2008). Exposure to low level GSM 935 MHz radiofrequency fields does not induce apoptosis in proliferating or differentiated murine neuroblastoma cells. *Radiat Prot Dosimetry*, 131: 287–296. doi:10.1093/rpd/ncn171 PMID:18550513
- Moran MM, Xu H, Clapham DE (2004). TRP ion channels in the nervous system. *Curr Opin Neurobiol*, 14: 362–369. doi:10.1016/j.conb.2004.05.003 PMID:15194117
- Moszczyński P, Lisiewicz J, Dmoch A *et al.* (1999). [The effect of various occupational exposures to microwave radiation on the concentrations of immunoglobulins and T lymphocyte subsets.] *Wiad Lek*, 52: 30–34. PMID:10335122
- Moulder JE, Erdreich LS, Malyapa RS *et al.* (1999). Cell phones and cancer: what is the evidence for a connection? *Radiat Res*, 151: 513–531. doi:10.2307/3580028 PMID:10319725
- Moulder JE, Foster KR, Erdreich LS, McNamee JP (2005). Mobile phones, mobile phone base stations and cancer: a review. *Int J Radiat Biol*, 81: 189–203. doi:10.1080/09553000500091097 PMID:16019928
- Nageswari KS, Sarma KR, Rajvanshi VS *et al.* (1991). Effect of chronic microwave radiation on T cell-mediated immunity in the rabbit. *Int J Biometeorol*, 35: 92–97. doi:10.1007/BF01087483 PMID:1743776
- Nam KC, Kim SW, Kim SC, Kim DW (2006). Effects of RF exposure of teenagers and adults by CDMA cellular phones. *Bioelectromagnetics*, 27: 509–514. doi:10.1002/bem.20229 PMID:16732587
- Nasta F, Prisco MG, Pinto R *et al.* (2006). Effects of GSM-modulated radiofrequency electromagnetic fields on B-cell peripheral differentiation and antibody production. *Radiat Res*, 165: 664–670. doi:10.1667/RR3555.1 PMID:16802866
- Nikolova T, Czyz J, Rolletschek A *et al.* (2005). Electromagnetic fields affect transcript levels of apoptosis-related genes in embryonic stem cell-derived neural progenitor cells. *FASEB J*, 19: 1686–1688. PMID:16116041
- Nittby H, Brun A, Eberhardt J *et al.* (2009). Increased blood-brain barrier permeability in mammalian brain 7 days after exposure to the radiation from a GSM-900 mobile phone. *Pathophysiology*, 16: 103–112. doi:10.1016/j.pathophys.2009.01.001 PMID:19345073
- Nittby H, Brun A, Strömblad S *et al.* (2011). Nonthermal GSM RF and ELF EMF effects upon rat BBB permeability. *Environmentalist*, 31: 140–148. doi:10.1007/s10669-011-9307-z
- Nittby H, Widegren B, Krogh M *et al.* (2008). Exposure to radiation from global system for mobile communications at 1800MHz significantly changes gene expression in rat hippocampus and cortex. *Environmentalist*, 28: 458–465.
- Novoselova EG, Fesenko EE, Makar VR, Sadovnikov VB (1999). Microwaves and cellular immunity. II. Immunostimulating effects of microwaves and naturally occurring antioxidant nutrients. *Bioelectrochem Bioenerg*, 49:37–41. doi:10.1016/S0302-4598(99)00059-8 PMID:10619446
- Novoselova ET & Fesenko EE (1998). [Stimulation of production of tumor necrosis factor by murine macrophages when exposed in vivo and in vitro to weak electromagnetic waves in the centimeter range] *Biofizika*, 43: 1132–1133. PMID:10079935
- Nylund R, Kuster N, Leszczynski D (2010). Analysis of proteome response to the mobile phone radiation in two types of human primary endothelial cells. *Proteome Sci*, 8: 52 doi:10.1186/1477-5956-8-52 PMID:20955554
- Nylund R & Leszczynski D (2004). Proteomics analysis of human endothelial cell line EA.hy926 after exposure to GSM 900 radiation. *Proteomics*, 4: 1359–1365. doi:10.1002/pmic.200300773 PMID:15188403
- Nylund R & Leszczynski D (2006). Mobile phone radiation causes changes in gene and protein expression in human endothelial cell lines and the response seems to be genome- and proteome-dependent. *Proteomics*, 6: 4769–4780. doi:10.1002/pmic.200600076 PMID:16878295
- Nylund R, Tammio H, Kuster N, Leszczynski D (2009). Proteomic analysis of the response of human endothelial cell line EA.hy926 to 1800 GSM mobile phone radiation. *J. Proteomics Bioinformatics.*, 2: 455–462. doi:10.4172/jpb.1000105
- Odaci E, Bas O, Kaplan S (2008). Effects of prenatal exposure to a 900 MHz electromagnetic field on the dentate gyrus of rats: a stereological and histopathological study. *Brain Res*, 1238: 224–229. doi:10.1016/j.brainres.2008.08.013 PMID:18761003
- Oktem F, Ozguner F, Mollaoglu H *et al.* (2005). Oxidative damage in the kidney induced by 900 MHz-emitted mobile phone: protection by melatonin. *Arch Med Res*, 36: 350–355. doi:10.1016/j.arcmed.2005.03.021 PMID:15950073
- Ono T, Saito Y, Komura J *et al.* (2004). Absence of mutagenic effects of 2.45 GHz radiofrequency exposure in spleen, liver, brain, and testis of lacZ-transgenic mouse exposed in utero. *Tohoku J Exp Med*, 202: 93–103. doi:10.1620/tjem.202.93 PMID:14998303
- Oral B, Guney M, Ozguner F *et al.* (2006). Endometrial apoptosis induced by a 900 MHz mobile phone:

- preventive effects of vitamins E and C. *Adv Ther*, 23: 957–973. doi:10.1007/BF02850217 PMID:17276964
- Othman OE, Aly MS, El Nahas SM (2001). Aneuploidy in workers occupationally exposed to electromagnetic fields detected by FISH. *Cytologia (Tokyo)*, 66: 117–125.
- Ozguner F, Altinbas A, Ozaydin M *et al.* (2005a). Mobile phone-induced myocardial oxidative stress: protection by a novel antioxidant agent caffeic acid phenethyl ester. *Toxicol Ind Health*, 21: 223–230. doi:10.1191/0748233705th228oa PMID:16342473
- Ozguner F, Bardak Y, Comlekci S (2006). Protective effects of melatonin and caffeic acid phenethyl ester against retinal oxidative stress in long-term use of mobile phone: a comparative study. *Mol Cell Biochem*, 282: 83–88. doi:10.1007/s11010-006-1267-0 PMID:16317515
- Ozguner F, Oktem F, Armagan A *et al.* (2005b). Comparative analysis of the protective effects of melatonin and caffeic acid phenethyl ester (CAPE) on mobile phone-induced renal impairment in rat. *Mol Cell Biochem*, 276: 31–37. doi:10.1007/s11010-005-2734-8 PMID:16132682
- Ozguner E, Güler G, Seyhan N (2010). Mobile phone radiation-induced free radical damage in the liver is inhibited by the antioxidants N-acetyl cysteine and epigallocatechin-gallate. *Int J Radiat Biol*, 86: 935–945. doi:10.3109/09553002.2010.496029 PMID:20807176
- Pacini S, Ruggiero M, Sardi I *et al.* (2002). Exposure to global system for mobile communication (GSM) cellular phone radiofrequency alters gene expression, proliferation, and morphology of human skin fibroblasts. *Oncol Res*, 13: 19–24. PMID:12201670
- Panagopoulos DJ (2011). Analyzing the health impacts of modern telecommunication microwaves. *Advances in Medicine and Biology*, 17: 1–55.
- Panagopoulos DJ, Chavdoula ED, Karabarbounis A, Margaritis LH (2007). Comparison of bioactivity between GSM 900 MHz and DCS 1800 MHz mobile telephony radiation. *Electromagn Biol Med*, 26: 33–44. doi:10.1080/15368370701205644 PMID:17454081
- Panagopoulos DJ, Chavdoula ED, Margaritis LH (2010). Bioeffects of mobile telephony radiation in relation to its intensity or distance from the antenna. *Int J Radiat Biol*, 86: 345–357. doi:10.3109/09553000903567961 PMID:20397839
- Panagopoulos DJ, Karabarbounis A, Margaritis LH (2004). Effects of GSM 900 MHz mobile phone radiation on the reproductive capacity of *Drosophila melanogaster*. *Electromagn Biol Med*, 23: 29–43. doi:10.1081/JBC-120039350
- Panagopoulos DJ, Margaritis LH (2008). *Mobile Telephony Radiation Effects on Living Organisms*. In *Mobile Telephones: Networks, Applications, and Performance*. Harper AC, Buress RV, editors. Nova Science Publishers, Inc., pp. 107–149.
- Panagopoulos DJ & Margaritis LH (2010a). The identification of an intensity ‘window’ on the bioeffects of mobile telephony radiation. *Int J Radiat Biol*, 86: 358–366. doi:10.3109/09553000903567979 PMID:20397840
- Panagopoulos DJ & Margaritis LH (2010b). The effect of exposure duration on the biological activity of mobile telephony radiation. *Mutat Res*, 699: 17–22. doi:10.1016/j.mrgentox.2010.04.010 PMID:20399887
- Paparini A, Rossi P, Gianfranceschi G *et al.* (2008). No evidence of major transcriptional changes in the brain of mice exposed to 1800 MHz GSM signal. *Bioelectromagnetics*, 29: 312–323. PMID:18175331
- Parazzini M, Ravazzani P, Tognola G *et al.* (2007). Electromagnetic fields produced by GSM cellular phones and heart rate variability. *Bioelectromagnetics*, 28: 122–129. doi:10.1002/bem.20275 PMID:17004239
- Patapoutian A, Peier AM, Story GM, Viswanath V (2003). ThermoTRP channels and beyond: mechanisms of temperature sensation. *Nat Rev Neurosci*, 4: 529–539. doi:10.1038/nrn1141 PMID:12838328
- Paull TT, Rogakou EP, Yamazaki V *et al.* (2000). A critical role for histone H2AX in recruitment of repair factors to nuclear foci after DNA damage. *Curr Biol*, 10: 886–895. doi:10.1016/S0960-9822(00)00610-2 PMID:10959836
- Paulraj R & Behari J (2006). Single strand DNA breaks in rat brain cells exposed to microwave radiation. *Mutat Res*, 596: 76–80. PMID:16458332
- Pavicic I & Trosic I (2008). In vitro testing of cellular response to ultra high frequency electromagnetic field radiation. *Toxicol In Vitro*, 22: 1344–1348. doi:10.1016/j.tiv.2008.04.014 PMID:18513921
- Penafiel LM, Litovitz T, Krause D *et al.* (1997). Role of modulation on the effect of microwaves on ornithine decarboxylase activity in L929 cells. *Bioelectromagnetics*, 18: 132–141. doi:10.1002/(SICI)1521-186X(1997)18:2<132::AID-BEM6>3.0.CO;2-3 PMID:9084864
- Persson BR, Salford LG, Brun A (1997). Blood–brain barrier permeability in rats exposed to electromagnetic fields used in wireless communication. *Wirel Netw*, 3: 455–461. doi:10.1023/A:1019150510840
- Phillips JL, Ivaschuk O, Ishida-Jones T *et al.* (1998). DNA damage in Molt-4 T-lymphoblastoid cells exposed to cellular telephone radiofrequency fields in vitro. *Bioelec Chem Bioenerg*, 45: 103–110. doi:10.1016/S0302-4598(98)00074-9
- Phillips JL, Singh NP, Lai H (2009). Electromagnetic fields and DNA damage. *Pathophysiology*, 16: 79–88. doi:10.1016/j.pathophys.2008.11.005 PMID:19264461
- Port M, Abend M, Römer B, Van Beuningen D (2003). Influence of high-frequency electromagnetic fields on different modes of cell death and gene expression. *Int J Radiat Biol*, 79: 701–708. doi:10.1080/09553000310001606803 PMID:14703943
- Pyrpasopoulou A, Kotoula V, Cheva A *et al.* (2004). Bone morphogenetic protein expression in newborn rat kidneys after prenatal exposure to radiofrequency

- radiation. *Bioelectromagnetics*, 25: 216–227. PMID:15042631
- Qutob SS, Chauhan V, Bellier PV *et al.* (2006). Microarray gene expression profiling of a human glioblastoma cell line exposed in vitro to a 1.9 GHz pulse-modulated radiofrequency field. *Radiat Res*, 165: 636–644. doi:10.1667/RR3561.1 PMID:16802863
- Radon K, Parera D, Rose DM *et al.* (2001). No effects of pulsed radio frequency electromagnetic fields on melatonin, cortisol, and selected markers of the immune system in man. *Bioelectromagnetics*, 22: 280–287. doi:10.1002/bem.51 PMID:11298390
- Regel SJ, Tinguely G, Schuderer J *et al.* (2007b). Pulsed radio-frequency electromagnetic fields: dose-dependent effects on sleep, the sleep EEG and cognitive performance. *J Sleep Res*, 16: 253–258. doi:10.1111/j.1365-2869.2007.00603.x PMID:17716273
- Reid SWJ & Gettinby G (1998). Radio-frequency electromagnetic field from mobile phones. *Lancet*, 352: 576–577. doi:10.1016/S0140-6736(05)79287-4 PMID:9716088
- Remondini D, Nylund R, Reivinen J *et al.* (2006). Gene expression changes in human cells after exposure to mobile phone microwaves. *Proteomics*, 6: 4745–4754. doi:10.1002/pmic.200500896 PMID:16878293
- Rüdiger H, Kratochvil E, Pilger A (2006). Reply to the letter by Vijayalaxmi *et al.* *Mutat Res*, 603: 107–109.
- Rüdiger HW (2009a). Genotoxic effects of radiofrequency electromagnetic fields. *Pathophysiology*, 16: 89–102. doi:10.1016/j.pathophys.2008.11.004 PMID:19285841
- Rüdiger HW (2009b). Answer to comments by A. Lerchl on “Radiofrequency electromagnetic fields (UMTS, 1,950 MHz) induce genotoxic effects in vitro in human fibroblasts but not in lymphocytes” published by C. Schwarz *et al.* 2008. *Int Arch Occup Environ Health*, 82: 279–283. doi:10.1007/s00420-008-0330-4 PMID:18481076
- Rüdiger HW (2009c). Letter to the editor: doubts raised about the blinding process do not apply to the Diem *et al.* paper. *Mutat Res*, 673: 2 PMID:19059497
- Ryan KL, Walters TJ, Tehrany MR *et al.* (1997). Age does not affect thermal and cardiorespiratory responses to microwave heating in calorically restricted rats. *Shock*, 8: 55–60. doi:10.1097/00024382-199707000-00009 PMID:9249913
- Sakuma N, Komatsubara Y, Takeda H *et al.* (2006). DNA strand breaks are not induced in human cells exposed to 2.1425 GHz band CW and W-CDMA modulated radiofrequency fields allocated to mobile radio base stations. *Bioelectromagnetics*, 27: 51–57. doi:10.1002/bem.20179 PMID:16283663
- Sakurai T, Kiyokawa T, Narita E *et al.* (2011). Analysis of gene expression in a human-derived glial cell line exposed to 2.45 GHz continuous radiofrequency electromagnetic fields. *J Radiat Res (Tokyo)*, 52: 185–192. doi:10.1269/jrr.10116 PMID:21343680
- Sanchez S, Haro E, Ruffié G *et al.* (2007). In vitro study of the stress response of human skin cells to GSM-1800 mobile phone signals compared to UVB radiation and heat shock. *Radiat Res*, 167: 572–580. doi:10.1667/RR0802.1 PMID:17474794
- Sanchez S, Masuda H, Billaudel B *et al.* (2006a). Effect of GSM-900 and –1800 signals on the skin of hairless rats. II: 12-week chronic exposures. *Int J Radiat Biol*, 82: 675–680. PMID:17050480
- Sanchez S, Masuda H, Ruffié G *et al.* (2008). Effect of GSM-900 and –1800 signals on the skin of hairless rats. III: Expression of heat shock proteins. *Int J Radiat Biol*, 84: 61–68. PMID:17852563
- Sanchez S, Milochau A, Ruffie G *et al.* (2006b). Human skin cell stress response to GSM-900 mobile phone signals. In vitro study on isolated primary cells and reconstructed epidermis. *FEBS J*, 273: 5491–5507. doi:10.1111/j.1742-4658.2006.05541.x PMID:17094784
- Sandström M, Lyskov E, Hörnsten R *et al.* (2003). Holter ECG monitoring in patients with perceived electrical hypersensitivity. *Int J Psychophysiol*, 49: 227–235. doi:10.1016/S0167-8760(03)00145-4 PMID:14507441
- Sandström M, Wilén J, Oftedal G, Hansson Mild K (2001). Mobile phone use and subjective symptoms. Comparison of symptoms experienced by users of analogue and digital mobile phones. *Occup Med (Lond)*, 51: 25–35. doi:10.1093/occmed/51.1.25 PMID:11235824
- Sannino A, Calabrese ML, d’Ambrosio G *et al.* (2006). Evaluation of cytotoxic and genotoxic effects in human peripheral blood leukocytes following exposure to 1950 MHz modulated signal. *IEEE Trans Plasma Sci*, 34: 1441–1448. doi:10.1109/TPS.2006.878379
- Sannino A, Di Costanzo G, Brescia F *et al.* (2009b). Human fibroblasts and 900 MHz radiofrequency radiation: evaluation of DNA damage after exposure and co-exposure to 3-chloro-4-(dichloromethyl)-5-hydroxy-2(5h)-furanone (MX). *Radiat Res*, 171: 743–751. doi:10.1667/RR1642.1 PMID:19580481
- Sannino A, Sarti M, Reddy SB *et al.* (2009a). Induction of adaptive response in human blood lymphocytes exposed to radiofrequency radiation. *Radiat Res*, 171: 735–742. doi:10.1667/RR1687.1 PMID:19580480
- Santini R, Santini P, Danze JM *et al.* (2002a). Investigation on the health of people living near mobile telephone relay stations: I/incidences according to distance and sex. *Pathol Biol (Paris)*, 50: 369–373. doi:10.1016/S0369-8114(02)00311-5 PMID:12168254
- Santini R, Seigne M, Bonhomme-Faivre L *et al.* (2002b). Symptoms experienced by users of digital cellular phones: A study of a french engineering school. *Electromagn Biol Med*, 21: 81–88. doi:10.1081/JBC-120003113
- Sarimov R, Malmgren LOG, Markova E *et al.* (2004). Nonthermal GSM microwaves affect chromatin conformation in human lymphocytes similar to heat shock.

- IEEE Trans Plasma Sci*, 32: 1600–1608. doi:10.1109/TPS.2004.832613
- Sarkar S, Ali S, Behari J (1994). Effect of low power microwave on the mouse genome: a direct DNA analysis. *Mutat Res*, 320: 141–147. doi:10.1016/0165-1218(94)90066-3 PMID:7506381
- Scarfi M, Lioi M, d'Ambrosio G *et al.* (1996). Genotoxic effects of mytomicin-C and microwave radiation on bovine lymphocytes *Electro-Magnetobiol.* 15: 99–104.
- Scarfi MR, Fresegna AM, Villani P *et al.* (2006). Exposure to radiofrequency radiation (900 MHz, GSM signal) does not affect micronucleus frequency and cell proliferation in human peripheral blood lymphocytes: an interlaboratory study. *Radiat Res*, 165: 655–663. doi:10.1667/RR3570.1 PMID:16802865
- Scarfi MR, Prisco F, Lioi MB *et al.* (1997a). Cytogenetic effects induced by extremely low frequency pulsed magnetic fields in lymphocytes from Turner's syndrome subjects. *Bioelectrochem Bioenerg*, 43: 221–226. doi:10.1016/S0302-4598(96)05156-2
- Scarfi MR, Prisco F, Lioi MB *et al.* (1997b). 50 Hz, 1 mT sinusoidal magnetic fields do not affect micronucleus frequency and cell proliferation in human lymphocytes from normal and Turner's syndrome subjects. *Electro Magnetobiol.*, 16: 301–307.
- Scarfi MR, Romano M, Di Pietro R *et al.* (2003). THz exposure of whole blood for the study of biological effects on human lymphocytes. *J Biol Phys*, 29: 171–177. doi:10.1023/A:1024440708943
- Schmid E & Schrader T (2007). Different biological effectiveness of ionising and non-ionising radiations in mammalian cells. *Adv Radio Sci.*, 5: 1–4. doi:10.5194/ars-5-1-2007
- Schrader T, Kleine-Ostmann T, Münter K *et al.* (2011). Spindle disturbances in human-hamster hybrid (A₁) cells induced by the electrical component of the mobile communication frequency range signal. *Bioelectromagnetics*, 32: 291–301. doi:10.1002/bem.20634 PMID:21452359
- Schrader T, Münter K, Kleine-Ostmann T, Schmid E (2008). Spindle disturbances in human-hamster hybrid (AL) cells induced by mobile communication frequency range signals. *Bioelectromagnetics*, 29: 626–639. doi:10.1002/bem.20428 PMID:18512695
- Schultz LB, Chehab NH, Malikzay A, Halazonetis TD (2000). p53 binding protein 1 (53BP1) is an early participant in the cellular response to DNA double-strand breaks. *J Cell Biol*, 151: 1381–1390. doi:10.1083/jcb.151.7.1381 PMID:11134068
- Schwartz JL, House DE, Mealing GA (1990). Exposure of frog hearts to CW or amplitude-modulated VHF fields: selective efflux of calcium ions at 16 Hz. *Bioelectromagnetics*, 11: 349–358. doi:10.1002/bem.2250110409 PMID:2285418
- Schwarz C, Kratochvil E, Pilger A *et al.* (2008). Radiofrequency electromagnetic fields (UMTS, 1,950 MHz) induce genotoxic effects in vitro in human fibroblasts but not in lymphocytes. *Int Arch Occup Environ Health*, 81: 755–767. doi:10.1007/s00420-008-0305-5 PMID:18278508
- Sedelnikova OA, Rogakou EP, Panyutin IG, Bonner WM (2002). Quantitative detection of ¹²⁵IIdU-induced DNA double-strand breaks with gamma-H2AX antibody. *Radiat Res*, 158: 486–492. doi:10.1667/0033-7587(2002)158[0486:QDOIID]2.CO;2 PMID:12236816
- Sekijima M, Takeda H, Yasunaga K *et al.* (2010). 2-GHz band CW and W-CDMA modulated radiofrequency fields have no significant effect on cell proliferation and gene expression profile in human cells. *J Radiat Res (Tokyo)*, 51: 277–284. doi:10.1269/jrr.09126 PMID:20215713
- Shcheglov VS, Belyaev IY, Ushakov VL, Alipov YD (1997). Power-dependent rearrangement in the spectrum of resonance effect of millimeter waves on the genome conformational state of E. coli cells *Electro- and Magnetobiology*, 16(1): 69–82.
- Shckorbatov YG, Grigoryeva NN, Shakhbazov VG *et al.* (1998). Microwave irradiation influences on the state of human cell nuclei. *Bioelectromagnetics*, 19: 414–419. doi:10.1002/(SICI)1521-186X(1998)19:7<414::AID-BEM2>3.0.CO;2-4 PMID:9771584
- Shckorbatov YG, Pasiuga VN, Kolchigin NN *et al.* (2009). The influence of differently polarised microwave radiation on chromatin in human cells. *Int J Radiat Biol*, 85: 322–329. doi:10.1080/09553000902781113 PMID:19399677
- Simkó M, Hartwig C, Lantow M *et al.* (2006). Hsp70 expression and free radical release after exposure to non-thermal radio-frequency electromagnetic fields and ultrafine particles in human Mono Mac 6 cells. *Toxicol Lett*, 161: 73–82. doi:10.1016/j.toxlet.2005.08.005 PMID:16153791
- Smiałowicz RJ, Rogers RR, Garner RJ *et al.* (1983). Microwaves (2,450 MHz) suppress murine natural killer cell activity. *Bioelectromagnetics*, 4: 371–381. doi:10.1002/bem.2250040408 PMID:6651889
- Sokolovic D, Djindjic B, Nikolic J *et al.* (2008). Melatonin reduces oxidative stress induced by chronic exposure of microwave radiation from mobile phones in rat brain. *J Radiat Res (Tokyo)*, 49: 579–586. doi:10.1269/jrr.07077 PMID:18827438
- Sonmez OF, Odaci E, Bas O, Kaplan S (2010). Purkinje cell number decreases in the adult female rat cerebellum following exposure to 900 MHz electromagnetic field. *Brain Res*, 1356: 95–101. doi:10.1016/j.brainres.2010.07.103 PMID:20691167
- Speit G, Schütz P, Hoffmann H (2007). Genotoxic effects of exposure to radiofrequency electromagnetic fields (RF-EMF) in cultured mammalian cells are not independently reproducible. *Mutat Res*, 626: 42–47. PMID:16997616

- Stagg RB, Hawel LH 3rd, Pastorian K *et al.* (2001). Effect of immobilization and concurrent exposure to a pulse-modulated microwave field on core body temperature, plasma ACTH and corticosteroid, and brain ornithine decarboxylase, Fos and Jun mRNA. *Radiat Res*, 155: 584–592. PMID:11260660
- Stagg RB, Thomas WJ, Jones RA, Adey WR (1997). DNA synthesis and cell proliferation in C6 glioma and primary glial cells exposed to a 836.55 MHz modulated radiofrequency field. *Bioelectromagnetics*, 18: 230–236. doi:10.1002/(SICI)1521-186X(1997)18:3<230::AID-BEM5>3.0.CO;2-3 PMID:9096841
- Stam R (2010). Electromagnetic fields and the blood-brain barrier. *Brain Res Brain Res Rev*, 65: 80–97. doi:10.1016/j.brainresrev.2010.06.001 PMID:20550949
- Stankiewicz W, Dąbrowski MP, Kubacki R *et al.* (2006). Immunotropic influence of 900 MHz microwave GSM signal on human blood immune cells activated in vitro. *Electromagn Biol Med*, 25: 45–51. doi:10.1080/15368370600572961 PMID:16595333
- Stronati L, Testa A, Moquet J *et al.* (2006). 935 MHz cellular phone radiation. An in vitro study of genotoxicity in human lymphocytes. *Int J Radiat Biol*, 82: 339–346. doi:10.1080/095530006000739173 PMID:16782651
- Sun LX, Yao K, Jiang H *et al.* (2006). DNA damage and repair induced by acute exposure of microwave from mobile phone on cultured human lens epithelial cells *Zhonghua Yan Ke Za Zhi*, 42: 1084–1088. PMID:17415965
- Sykes PJ, McCallum BD, Bangay MJ *et al.* (2001). Effect of exposure to 900 MHz radiofrequency radiation on intrachromosomal recombination in pKZ1 mice. *Radiat Res*, 156: 495–502. doi:10.1667/0033-7587(2001)156[0495:EOETMR]2.0.CO;2 PMID:11604062
- Sylvester PW, Shah SJ, Haynie DT, Briski KP (2005). Effects of ultra-wideband electromagnetic pulses on pre-neoplastic mammary epithelial cell proliferation. *Cell Prolif*, 38: 153–163. doi:10.1111/j.1365-2184.2005.00340.x PMID:15985060
- Tahvanainen K, Niño J, Halonen P *et al.* (2004). Cellular phone use does not acutely affect blood pressure or heart rate of humans. *Bioelectromagnetics*, 25: 73–83. doi:10.1002/bem.10165 PMID:14735556
- Takahashi S, Inaguma S, Cho YM *et al.* (2002). Lack of mutation induction with exposure to 1.5 GHz electromagnetic near fields used for cellular phones in brains of Big Blue mice. *Cancer Res*, 62: 1956–1960. PMID:11929810
- Takashima Y, Hirose H, Koyama S *et al.* (2006). Effects of continuous and intermittent exposure to RF fields with a wide range of SARs on cell growth, survival, and cell cycle distribution. *Bioelectromagnetics*, 27: 392–400. doi:10.1002/bem.20220 PMID:16615058
- Thomas P & Fenech M (2011). Buccal micronucleus cytome assay. *Methods Mol Biol*, 682: 235–248. doi:10.1007/978-1-60327-409-8_17 PMID:21057932
- Tian F, Nakahara T, Wake K *et al.* (2002). Exposure to 2.45 GHz electromagnetic fields induces hsp70 at a high SAR of more than 20 W/kg but not at 5W/kg in human glioma MO54 cells. *Int J Radiat Biol*, 78: 433–440. doi:10.1080/09553000110115649 PMID:12020433
- Tice RR, Hook GG, Donner M *et al.* (2002). Genotoxicity of radiofrequency signals. I. Investigation of DNA damage and micronuclei induction in cultured human blood cells. *Bioelectromagnetics*, 23: 113–126. doi:10.1002/bem.104 PMID:11835258
- Tiwari R, Lakshmi NK, Surender V *et al.* (2008). Combinative exposure effect of radio frequency signals from CDMA mobile phones and aphidicolin on DNA integrity. *Electromagn Biol Med*, 27: 418–425. doi:10.1080/15368370802473554 PMID:19037791
- Tomruk A, Guler G, Dincel AS (2010). The influence of 1800 MHz GSM-like signals on hepatic oxidative DNA and lipid damage in nonpregnant, pregnant, and newly born rabbits. *Cell Biochem Biophys*, 56: 39–47. doi:10.1007/s12013-009-9068-1 PMID:19851891
- Trosic I & Busljeta I (2006). Erythropoietic dynamic equilibrium in rats maintained after microwave irradiation. *Exp Toxicol Pathol*, 57: 247–251. doi:10.1016/j.etp.2005.08.002 PMID:16410191
- Trosic I, Busljeta I, Kasuba V, Rozgaj R (2002). Micronucleus induction after whole-body microwave irradiation of rats. *Mutat Res*, 521: 73–79. PMID:12438005
- Trosic I, Busljeta I, Modlic B (2004). Investigation of the genotoxic effect of microwave irradiation in rat bone marrow cells: in vivo exposure. *Mutagenesis*, 19: 361–364. doi:10.1093/mutage/geh042 PMID:15388808
- Trosic I & Pavicic I (2009). Disturbance of cell proliferation in response to mobile phone frequency radiation. *Arh Hig Rada Toksikol*, 60: 109–115. PMID:19329382
- Tuffs A (2008). University calls for mobile phone research to be withdrawn after technician admits faking data. *BMJ*, 336: 1270 doi:10.1136/bmj.39598.629271.DB PMID:18535061
- Tuschl H, Neubauer G, Garn H *et al.* (1999). Occupational exposure to high frequency electromagnetic fields and its effect on human immune parameters. *Int J Occup Med Environ Health*, 12: 239–251. PMID:10581865
- Tuschl HW, Novak W, Molla-Djafari H (2006). In vitro effects of GSM modulated radiofrequency fields on human immune cells. *Bioelectromagnetics*, 27: 188–196. doi:10.1002/bem.20191 PMID:16342197
- Ushakov VL, Alipov ED, Shcheglov VS, Beliaev I (2006a). Peculiarities of non-thermal effects of microwaves in the frequency range of 51–52 GHz on E. coli cells. *Radiats Biol Radioecol*, 46: 719–728. PMID:17323701
- Ushakov VL, Alipov ED, Shcheglov VS, Beliaev I (2006b). The effects of the microwaves on E. coli cells depend on

- oxygen concentration and static magnetic field *Radiat Biol Radioecol*, 46: 729–734. PMID:17323702.
- Ushakov VL, Shcheglov VS, Belyaev IY, Harms-Ringdahl M (1999). Combined effects of circularly polarized microwaves and ethidium bromide on *E. coli* cells *Electro- and Magnetobiology*, 18: 233–242.
- Valbonesi P, Franzellitti S, Piano A *et al.* (2008). Evaluation of HSP70 expression and DNA damage in cells of a human trophoblast cell line exposed to 1.8 GHz amplitude-modulated radiofrequency fields. *Radiat Res*, 169: 270–279. doi:10.1667/RR1061.1 PMID:18302482
- Vanderstraeten J & Verschaeve L (2008). Gene and protein expression following exposure to radiofrequency fields from mobile phones. *Environ Health Perspect*, 116: 1131–1135. doi:10.1289/ehp.11279 PMID:18795152
- Vanderwaal RP, Cha B, Moros EG, Roti Roti JL (2006). HSP27 phosphorylation increases after 45 degrees C or 41 degrees C heat shocks but not after non-thermal TDMA or GSM exposures. *Int J Hyperthermia*, 22: 507–519. doi:10.1080/02656730600924406 PMID:16971370
- Velizarov S, Raskmark P, Kwee S (1999). The effects of radiofrequency fields on cell proliferation are non-thermal. *Bioelectrochem Bioenerg*, 48: 177–180. doi:10.1016/S0302-4598(98)00238-4 PMID:10228585
- Verschaeve L (2005). Genetic effects of radiofrequency radiation (RFR). *Toxicol Appl Pharmacol*, 207: Suppl336–341. doi:10.1016/j.taap.2005.03.028 PMID:16019045
- Verschaeve L (2009). Genetic damage in subjects exposed to radiofrequency radiation. *Mutat Res*, 681: 259–270. doi:10.1016/j.mrrev.2008.11.002 PMID:19073278
- Verschaeve L, Heikkinen P, Verheyen G *et al.* (2006). Investigation of co-genotoxic effects of radiofrequency electromagnetic fields in vivo. *Radiat Res*, 165: 598–607. doi:10.1667/RR3559.1 PMID:16669742
- Verschaeve L, Juutilainen J, Lagroye I *et al.* (2010). In vitro and in vivo genotoxicity of radiofrequency fields. *Mutat Res*, 705: 252–268. doi:10.1016/j.mrrev.2010.10.001 PMID:20955816
- Verschaeve L & Maes A (1998). Genetic, carcinogenic and teratogenic effects of radiofrequency fields. *Mutat Res*, 410: 141–165. doi:10.1016/S1383-5742(97)00037-9 PMID:9637234
- Veyret B, Bouthet C, Deschaux P *et al.* (1991). Antibody responses of mice exposed to low-power microwaves under combined, pulse-and-amplitude modulation. *Bioelectromagnetics*, 12: 47–56. doi:10.1002/bem.2250120107 PMID:2012621
- Vijayalaxmi, Bisht KS, Pickard WF *et al.* (2001c). Chromosome damage and micronucleus formation in human blood lymphocytes exposed *in vitro* to radiofrequency radiation at a cellular telephone frequency (847.74 MHz, CDMA). *Radiat Res*, 156: 430–432. doi:10.1667/0033-7587(2001)156[0430:CDAMFI]2.0.CO;2 PMID:11554855
- Vijayalaxmi, Frei MR, Dusch SJ *et al.* (1997a). Frequency of micronuclei in the peripheral blood and bone marrow of cancer-prone mice chronically exposed to 2450 MHz radiofrequency radiation. *Radiat Res*, 147: 495–500. doi:10.2307/3579508 PMID:9092931
- Vijayalaxmi, Frei MR, Dusch SJ *et al.* (1998). Correction of an error in calculation in the article “Frequency of micronuclei in the peripheral blood and bone marrow of cancer-prone mice chronically exposed to 2450 MHz radiofrequency radiation” (*Radiat. Res.* 147, 495–500, 1997) *Radiat Res*, 149: 308 doi:10.2307/3579965 PMID:9496895
- Vijayalaxmi, Leal BZ, Meltz ML *et al.* (2001b). Cytogenetic studies in human blood lymphocytes exposed in vitro to radiofrequency radiation at a cellular telephone frequency (835.62 MHz, FDMA). *Radiat Res*, 155: 113–121. doi:10.1667/0033-7587(2001)155[0113:CSIHB L]2.0.CO;2 PMID:11121222
- Vijayalaxmi, Leal BZ, Szilagyi M *et al.* (2000). Primary DNA damage in human blood lymphocytes exposed in vitro to 2450 MHz radiofrequency radiation. *Radiat Res*, 153: 479–486. doi:10.1667/0033-7587(2000)153[0479:PDDI HB]2.0.CO;2 PMID:10761010
- Vijayalaxmi, Logani MK, Bhanushali A *et al.* (2004). Micronuclei in peripheral blood and bone marrow cells of mice exposed to 42 GHz electromagnetic millimeter waves. *Radiat Res*, 161: 341–345. doi:10.1667/RR3121 PMID:14982479
- Vijayalaxmi, McNamee JP, Scarfi MR (2006). Comments on: “DNA strand breaks” by Diem *et al.* [*Mutat. Res.* 583 (2005) 178–183] and Ivancsits *et al.* [*Mutat. Res.* 583 (2005) 184–188]. *Mutat Res*, 603: 104–106, author reply 107–109. PMID:16384726
- Vijayalaxmi, Mohan N, Meltz ML, Wittler MA (1997b). Proliferation and cytogenetic studies in human blood lymphocytes exposed in vitro to 2450 MHz radiofrequency radiation. *Int J Radiat Biol*, 72: 751–757. doi:10.1080/095530097142915 PMID:9416798
- Vijayalaxmi & Obe G (2004). Controversial cytogenetic observations in mammalian somatic cells exposed to radiofrequency radiation. *Radiat Res*, 162: 481–496. doi:10.1667/RR3252 PMID:15624303
- Vijayalaxmi, Pickard WF, Bisht KS *et al.* (2001a). Micronuclei in the peripheral blood and bone marrow cells of rats exposed to 2450 MHz radiofrequency radiation. *Int J Radiat Biol*, 77: 1109–1115. doi:10.1080/09553000110069100 PMID:11683981
- Vijayalaxmi & Prihoda TJ (2008). Genetic damage in mammalian somatic cells exposed to radiofrequency radiation: a meta-analysis of data from 63 publications (1990–2005). *Radiat Res*, 169: 561–574. doi:10.1667/RR0987.1 PMID:18494173
- Vijayalaxmi, Sasser LB, Morris JE *et al.* (2003). Genotoxic potential of 1.6 GHz wireless communication signal: in vivo two-year bioassay. *Radiat Res*, 159: 558–564.

- doi:10.1667/0033-7587(2003)159[0558:GPOGWC]2.0.CO;2 PMID:12643801
- Vijayalaxmi , Scarfi MR, Prihoda TJ (2007). Comments on the Reports of Gandhi and Colleagues (2005) "Cytogenetic Damage in Mobile Phone Users *Int J Hum Genet.*, 7: 325–327.
- Vijayalaxmi , Seaman RL, Belt ML *et al.* (1999). Frequency of micronuclei in the blood and bone marrow cells of mice exposed to ultra-wideband electromagnetic radiation. *Int J Radiat Biol*, 75: 115–120. doi:10.1080/095530099140870 PMID:9972798
- Vogel G (2008). Scientific misconduct. Fraud charges cast doubt on claims of DNA damage from cell phone fields. *Science*, 321: 1144–1145. doi:10.1126/science.321.5893.1144a PMID:18755946
- Volkow ND, Tomasi D, Wang GJ *et al.* (2011). Effects of cell phone radiofrequency signal exposure on brain glucose metabolism. *JAMA*, 305: 808–813. doi:10.1001/jama.2011.186 PMID:21343580
- Von Kleist H (1811). *Der zerbrochne Krug, ein Lustspiel.* Realschulbuchhandlung Berlin. 174 pp
- Wagner P, Röschke J, Mann K *et al.* (1998). Human sleep under the influence of pulsed radiofrequency electromagnetic fields: a polysomnographic study using standardized conditions. *Bioelectromagnetics*, 19: 199–202. doi:10.1002/(SICI)1521-186X(1998)19:3<199::AID-BEM8>3.0.CO;2-X PMID:9554698
- Wagner P, Röschke J, Mann K *et al.* (2000). Human sleep EEG under the influence of pulsed radio frequency electromagnetic fields. Results from polysomnographies using submaximal high power flux densities. *Neuropsychobiology*, 42: 207–212. doi:10.1159/000026695 PMID:11096337
- Wang J, Koyama S, Komatsubara Y *et al.* (2006). Effects of a 2450 MHz high-frequency electromagnetic field with a wide range of SARs on the induction of heat-shock proteins in A172 cells. *Bioelectromagnetics*, 27: 479–486. doi:10.1002/bem.20226 PMID:16622864
- Weisbrot D, Lin H, Ye L *et al.* (2003). Effects of mobile phone radiation on reproduction and development in *Drosophila melanogaster*. *J Cell Biochem*, 89: 48–55. PMID:12682907
- Whitehead TD, Moros EG, Brownstein BH, Roti Roti JL (2006). Gene expression does not change significantly in C3H 10T(1/2) cells after exposure to 847.74 CDMA or 835.62 FDMA radiofrequency radiation. *Radiat Res*, 165: 626–635. doi:10.1667/RR3560.1 PMID:16802862
- Wolf C (2008). Security considerations in blinded exposure experiments using electromagnetic waves. *Bioelectromagnetics*, 29: 658–659. doi:10.1002/bem.20440 PMID:18671233
- Wood AW, Loughran SP, Stough C (2006). Does evening exposure to mobile phone radiation affect subsequent melatonin production? *Int J Radiat Biol*, 82: 69–76. doi:10.1080/09553000600599775 PMID:16546905
- Xu S, Zhou Z, Zhang L *et al.* (2010). Exposure to 1800 MHz radiofrequency radiation induces oxidative damage to mitochondrial DNA in primary cultured neurons. *Brain Res*, 1311: 189–196. doi:10.1016/j.brainres.2009.10.062 PMID:19879861
- Yadav AS & Sharma MK (2008). Increased frequency of micronucleated exfoliated cells among humans exposed *in vivo* to mobile telephone radiations. *Mutat Res*, 650: 175–180. PMID:18248768
- Yan JG, Agresti M, Zhang LL *et al.* (2008). Upregulation of specific mRNA levels in rat brain after cell phone exposure. *Electromagn Biol Med*, 27: 147–154. PMID:18568932
- Yan JG, Agresti M, Zhang LL *et al.* (2009). Qualitative effect on mRNAs of injury-associated proteins by cell phone like radiation in rat facial nerves. *Electromagn Biol Med*, 28: 383–390. PMID:20017629
- Yao K, Wang KJ, Sun ZH *et al.* (2004). Low power microwave radiation inhibits the proliferation of rabbit lens epithelial cells by upregulating P27Kip1 expression. *Mol Vis*, 10: 138–143. PMID:14990889
- Yao K, Wu W, Wang K *et al.* (2008). Electromagnetic noise inhibits radiofrequency radiation-induced DNA damage and reactive oxygen species increase in human lens epithelial cells. *Mol Vis*, 14: 964–969. PMID:18509546
- Yuan ZQ, Li F, Wang DG *et al.* (2004). [Effect of low intensity and very high frequency electromagnetic radiation on occupationally exposed personnel] *Zhonghua Lao Dong Wei Sheng Zhi Ye Bing Za Zhi*, 22: 267–269. PMID:15355705
- Zeng Q, Chen G, Weng Y *et al.* (2006). Effects of global system for mobile communications 1800 MHz radiofrequency electromagnetic fields on gene and protein expression in MCF-7 cells. *Proteomics*, 6: 4732–4738. doi:10.1002/pmic.200600234 PMID:16888767
- Zeni O, Chiavoni AS, Sannino A *et al.* (2003). Lack of genotoxic effects (micronucleus induction) in human lymphocytes exposed *in vitro* to 900 MHz electromagnetic fields. *Radiat Res*, 160: 152–158. doi:10.1667/RR3014 PMID:12859225
- Zeni O, Di Pietro R, d'Ambrosio G *et al.* (2007b). Formation of reactive oxygen species in L929 cells after exposure to 900 MHz RF radiation with and without co-exposure to 3-chloro-4-(dichloromethyl)-5-hydroxy-2(5H)-furanone. *Radiat Res*, 167: 306–311. doi:10.1667/RR0595.1 PMID:17316071
- Zeni O, Gallerano GP, Perrotta A *et al.* (2007a). Cytogenetic observations in human peripheral blood leukocytes following *in vitro* exposure to THz radiation: a pilot study. *Health Phys*, 92: 349–357. doi:10.1097/01.HP.0000251248.23991.35 PMID:17351499
- Zeni O, Romanò M, Perrotta A *et al.* (2005). Evaluation of genotoxic effects in human peripheral blood leukocytes following an acute *in vitro* exposure to 900 MHz

- radiofrequency fields. *Bioelectromagnetics*, 26: 258–265. doi:10.1002/bem.20078 PMID:15832336
- Zeni O, Schiavoni A, Perrotta A *et al.* (2008). Evaluation of genotoxic effects in human leukocytes after *in vitro* exposure to 1950 MHz UMTS radiofrequency field. *Bioelectromagnetics*, 29: 177–184. doi:10.1002/bem.20378 PMID:18027845
- Zhadobov M, Sauleau R, Le Coq L *et al.* (2007). Low-power millimeter wave radiations do not alter stress-sensitive gene expression of chaperone proteins. *Bioelectromagnetics*, 28: 188–196. doi:10.1002/bem.20285 PMID:17080454
- Zhang DY, Xu ZP, Chiang H *et al.* (2006). (Effects of GSM 1800 MHz radiofrequency electromagnetic fields on DNA damage in Chinese hamster lung cells) *Zhonghua Yu Fang Yi Xue Za Zhi*, 40: 149–152. PMID:16836873
- Zhang MB, He JL, Jin LF, Lu DQ (2002). Study of low-intensity 2450 MHz microwave exposure enhancing the genotoxic effects of mitomycin C using micronucleus test and comet assay *in vitro*. *Biomed Environ Sci*, 15: 283–290. PMID:12642984
- Zhao R, Zhang S, Xu Z *et al.* (2007b). Studying gene expression profile of rat neuron exposed to 1800MHz radiofrequency electromagnetic fields with cDNA microarray. *Toxicology*, 235: 167–175. doi:10.1016/j.tox.2007.03.015 PMID:17449163
- Zhao TY, Zou SP, Knapp PE (2007a). Exposure to cell phone radiation up-regulates apoptosis genes in primary cultures of neurons and astrocytes. *Neurosci Lett*, 412: 34–38. doi:10.1016/j.neulet.2006.09.092 PMID:17187929
- Zhijian C, Xiaoxue L, Yezhen L *et al.* (2009). Influence of 1.8-GHz (GSM) radiofrequency radiation (RFR) on DNA damage and repair induced by X-rays in human leukocytes *in vitro*. *Mutat Res*, 677: 100–104. PMID:19501185
- Zhijian C, Xiaoxue L, Yezhen L *et al.* (2010). Impact of 1.8-GHz radiofrequency radiation (RFR) on DNA damage and repair induced by doxorubicin in human B-cell lymphoblastoid cells. *Mutat Res*, 695: 16–21. PMID:19833226
- Ziemann C, Brockmeyer H, Reddy SB *et al.* (2009). Absence of genotoxic potential of 902 MHz (GSM) and 1747 MHz (DCS) wireless communication signals: *In vivo* two-year bioassay in B6C3F1 mice. *Int J Radiat Biol*, 85: 454–464. doi:10.1080/09553000902818907 PMID:19365745
- Zmysłony M, Politanski P, Rajkowska E *et al.* (2004). Acute exposure to 930 MHz CW electromagnetic radiation *in vitro* affects reactive oxygen species level in rat lymphocytes treated by iron ions. *Bioelectromagnetics*, 25: 324–328. doi:10.1002/bem.10191 PMID:15197754
- Zotti-Martelli L, Peccatori M, Maggini V *et al.* (2005). Individual responsiveness to induction of micronuclei in human lymphocytes after exposure *in vitro* to 1800 MHz microwave radiation. *Mutat Res*, 582: 42–52. PMID:15781209
- Zotti-Martelli L, Peccatori M, Scarpato R, Migliore L (2000). Induction of micronuclei in human lymphocytes exposed *in vitro* to microwave radiation. *Mutat Res*, 472: 51–58. PMID:11113697

5. SUMMARY OF DATA REPORTED

5.1 Exposure data

This Monograph is concerned with non-ionizing radiation in the radiofrequency (RF) range of the electromagnetic spectrum, i.e. between 30 kHz and 300 GHz. The corresponding wavelengths – the distance between successive peaks of the RF waves – range from 10 km to 1 mm, respectively. Human exposure to RF radiation can occur from many different sources and under a wide variety of circumstances, including the use of personal devices (mobile phones, cordless phones, Wi-Fi, Bluetooth, amateur radios, etc.), occupational sources (high-frequency dielectric and induction heaters, broadcast antennas, high-power pulsed radars, and medical applications), and environmental sources (mobile-phone base stations, broadcast antennae). These multiple sources contribute to an individual's total exposure, with contributions varying by different characteristics, e.g. place of residence. The dominant sources of human exposure to RF radiation are near-field sources for workers, and transmitters operating on or in close vicinity to the body, such as hand-held devices, for the general population.

Electromagnetic fields generated by RF sources couple with the human body, which results in induced electric and magnetic fields and associated currents inside body tissues. The most important factor that determines exposure is the distance of the transmitter from the human body, within the main radiation beam. In a first approximation, the induced field strength

is proportional to the time-averaged radiated power and inversely proportional to the distance from the source. In addition to distance, the efficiency of coupling and the resulting field distribution inside the body strongly depend on properties of the fields, such as frequency, polarization, distance from the antenna and direction of incidence, and on anatomical features of the exposed person, including height, posture, body mass index, shape of the head and associated structures such as the pinna (the outer ear), and dielectric properties of tissues. Induced fields within the body are highly non-uniform, with local hotspots and variations of several orders of magnitude. An important theme in studies on RF dosimetry is the focus on demonstrating compliance with exposure limits defined in terms of the localized and whole-body specific absorption rate (SAR) of energy. In recent years, measurement and simulation tools have been refined to allow exposure estimates in specific tissues or organs to be made for particular exposure scenarios, including those involving devices such as mobile phones.

While the number of mobile-phone subscriptions has been increasing rapidly around the world (4.6 billion subscribers in 2009), changes in mobile-phone technology have led to lower time-averaged RF power emitted from mobile phones used at present than those of previous generations. Of major interest to this *Monograph* is the exposure scenario in which mobile phones are held against the ear during a voice call. The

magnitude and spatial distribution of the ensuing SAR inside the brain depend on the design of a phone and its antenna, its position relative to the head, the anatomy of the head, how the hand holds the phone, as well as on the quality of the connection between the base station and the phone. GSM900/1800/PCS phones (Global System for Mobile communications/Personal Communications Service, operating at 900 or 1800 MHz) held next to the ear induce high spatial-averaged SAR values in the brain. This is because adaptive power control on average only reduces the output power to about 50% of its maximum during calls, but this would vary depending on the network software. The use of discontinuous transmission during voice calls would give a further 30% reduction in power. Analogue phones, which ceased to be used around the year 2000, produced still higher absorption of energy in the brain for two reasons: the handsets had higher output powers than modern phones, and the larger size of the handsets and antennae led to a more diffuse pattern of energy absorption in the head. Adaptive power control is much more effective with third-generation (3G) phone technologies, and this has led to a reduction of SAR in the brain by almost two orders of magnitude compared with that from GSM phones. The DECT (Digital Enhanced Cordless Telecommunications) phone is another widely used device that is held against the ear to make and receive voice calls. The average SAR in the brain from use of DECT phones is around five times lower than that measured for GSM phones.

The maximum spatial peak exposure to RF fields from mobile phones is very similar between different technologies. However, it may vary by up to a factor of 10 dependent on specific phone design. The spatial maximum exposure from cordless DECT phones is an order of a magnitude lower than that from mobile phones. Modulation and access schemes have also evolved to give a complicated output-power variation with time,

while analogue technologies had a more constant pattern of output power.

Mobile-phone use is widespread in industrialized countries and rapidly growing elsewhere. Certain phone functions, such as text messaging, which involves considerably less exposure than voice calls, have become very popular among teenagers. Due to the closer proximity of the phone to the brain of children compared with adults, the average exposure from use of the same mobile phone is higher by a factor of 2 in a child's brain and higher by a factor of 10 in the bone marrow of the skull. In addition, dielectric properties of certain tissues, notably the bone marrow, change with age. The marrow progressively incorporates more fat, and the bone itself increases in thickness, hardens, and loses water over time. Both these tissues, therefore, have a higher conductivity in children than in adults and they receive a higher energy deposition from RF sources.

The use of hands-free kits lowers exposures from mobile phones to less than 10% of the value resulting from use at the ear, but it may increase exposure to other parts of the body. The rise in temperature inside the brain from use of a typical 3G mobile phone is small, approximately 0.1 °C or less.

Measures of mobile-phone use for epidemiological studies have historically relied on self-reporting, but recent validation studies among adults and children have demonstrated that there can be considerable random and systematic errors in the reported number of calls, the duration of calls, and the side of head where the phone is held during use. This is particularly problematic for epidemiological studies of cancer in humans, where information is needed on phone use many years in the past.

Assessments of household exposures to RF radiation often rely on spot measurements with a focus on burst activity, rather than on average values over time, which are better measures of RF exposure. Environmental sources are dominated

by possible RF exposures from being in close proximity to mobile-phone base stations, but actual measurements have shown that distance to a base station is not a good proxy for exposure, due to the considerable variability in characteristics of the antennae, and shielding and reflection of the waves. Typical exposures from rooftop- or tower-mounted mobile-phone base stations are lower by more than five orders of magnitude than those from GSM handsets. Exposures to the brain from television and radio stations are typically lower than those from base stations. Epidemiological studies of environmental RF sources need to include rigorous assessments of exposures to RF radiation, documented by direct measurements or through validated models.

Many occupations involve the use of sources of RF radiation at much higher power levels than those from mobile phones. For people exposed to high-power RF sources at work, cumulative energy deposition in the whole body may be much greater than from mobile-phone use, but the spatial peak SAR in the head will be less.

Tissue heating is the most firmly established mechanism for effects of RF radiation in biological systems. Although it has been argued that RF radiation cannot induce physiological effects at exposure intensities that do not cause a detectable increase in tissue temperature, except for reactions mediated by free radical pairs, it is likely that not all mechanisms of interaction between weak RF fields, with the various signal modulations used in wireless communications, and biological structures have yet been discovered or fully characterized.

The International Commission on Non-Ionizing Radiation Protection (ICNIRP) and the Institute of Electrical and Electronics Engineers (IEEE) have developed guidelines for maximum human exposures to RF fields. These guidelines are designed to protect against adverse effects due to whole-body or partial body heating as a result of energy absorption above 100 kHz,

and against nervous system effects at frequencies up to 10 MHz.

5.2 Human carcinogenicity data

The epidemiological evidence on possible associations of exposure to RF radiation with cancer comes from studies of diverse design that have assessed a range of sources of exposure: the populations included people exposed in occupational settings, people exposed through sources in the general environment, e.g. transmission towers, and people exposed through use of wireless (mobile and cordless) telephones. The most robust evidence is for mobile phones, the most extensively investigated exposure source. The general methodological concerns related to this evidence are covered in the introduction to Section 2 and are not reviewed again here.

As for any compilation of findings of epidemiological studies, interpretation of this evidence needs to give consideration to the possibility that observed associations reflect chance, bias, or confounding, rather than an underlying causal effect. The investigation of risk of cancer of the brain associated with mobile-phone use poses complex methodological challenges in the conduct of the research and in the analysis and interpretation of the findings.

5.2.1 Personal use of wireless telephones

(a) *Tumours of the central nervous system: gliomas of the brain*

One cohort study from Denmark and five case-control studies (from the USA, Finland, Greece, Sweden, and a multicentre international study) were judged by the Working Group to offer useful epidemiological information regarding associations between use of wireless phones and glioma. There are also several studies of time trends in occurrence of cancer of the brain in relation to the great temporal increase in mobile-phone use.

(i) Time-trend studies

It has been suggested that time trends in the incidence of cancer might reflect the impact of increasing use of mobile phones on cancer risk. In that regard, there have been some reports from various countries describing rates of brain cancer over time. In general, there has not been a documented and stable increase in rates since the advent of the mobile-phone era. However, the general absence of any documented increase in rates of tumours of the brain must be interpreted in light of the fact that most time trends were examined only before the early 2000s. However, any large risk associated with relatively recent exposure should have been detected in the studies conducted to date. Time trends in cancer of the brain have not shown evidence of a trend that would indicate a promptly acting and powerful carcinogenic effect of mobile-phone use.

(ii) Cohort study and early case–control studies

A large cohort study in the entire population of Denmark included mobile-phone subscribers with a median of 8 years of subscription. The study showed no excess risk of glioma, based on 257 exposed cases. Because of the reliance on subscription to a mobile-phone provider as a surrogate for mobile-phone use, this study involved considerable misclassification in exposure assessment.

Several case–control studies were carried out in a time window that was relatively early in the period of rising use. Three of these studies used self-reported histories of mobile-phone use, while a Finnish study made a link to mobile-phone subscription records. Effect estimates from these studies were generally too imprecise to make them informative.

(iii) The INTERPHONE study

The INTERPHONE study, a multicentre case–control study, comprised the largest investigation so far of mobile-phone use and brain tumours, including component studies of

glioma, acoustic neuroma, and meningioma. The Working Group primarily considered the pooled analyses published in 2010 and 2011, rather than the findings as reported by site investigators or groups of investigators.

The pooled analysis of the INTERPHONE study on the risk of glioma in relation to use of mobile phones included 2708 cases of glioma and 2972 controls. Participation rates were 64% among cases of glioma and 53% among controls, with a wide variation in control participation rates among centres. For regular users, an overall reduced odds ratio (OR) was seen for glioma (OR, 0.81; 95% confidence interval [CI], 0.70–0.94); this was also observed in most study centres. Odds ratios of below unity were also found for all categories of time since start of use and of cumulative number of calls. The reason for these low odds ratios has not been established, but they probably reflect selection bias, at least in part. In terms of cumulative call time, all odds ratios were uniformly below unity for all deciles of exposure except for the highest decile (≥ 1640 hours of cumulative call time). For this exposure group, the odds ratio for glioma was 1.40 (95% CI, 1.03–1.89). Some other analyses of the same data also pointed to a possible association of mobile-phone use with risk of glioma, including the findings related to location of tumour (a higher odds ratio for tumours in the temporal lobe) and laterality of mobile-phone use (an apparently higher odds ratio in those who used a mobile phone on the same side of the head as the tumour). In an attempt to obviate the distortions that might have been generated by differential non-participation, an analysis was conducted with the lowest exposure decile as the reference; this showed a high odds ratio in the highest exposure decile. Recent reports presented findings based on methodological enhancements that derived dose indicators based on models applied to magnetic resonance imaging or computed tomography scans of the cases; these analyses in subsets of the INTERPHONE studies provide

additional insights into the patterns of risk of glioma associated with mobile-phone use.

The Working Group recognized several strengths of the INTERPHONE study, including its large sample size, the common core protocol, rapid case ascertainment, comprehensive data collection, and in-depth data analyses that included a wide variety of sensitivity and validation studies. However, the rather low participation rates may well have led to complicated and important patterns of selection bias.

In summary, in the INTERPHONE study there was no increased risk of glioma associated with having ever been a regular user of mobile phones. However, there were indications of an increased risk of glioma at the highest levels of cumulative call time, for ipsilateral exposures, and for tumours in the temporal lobe, but chance or bias may explain this increased risk.

(iv) *Studies from Sweden*

In 2011, Swedish investigators reported the findings of a pooled analysis of associations of mobile-phone and cordless-phone use and risk of glioma. Cases were ascertained from 1997 through 2003 in two waves. The Working Group considered the latest combined analysis of the study data. Both cases and controls were selected by use of population registries. A sequential approach by self-administered questionnaire and interview was used to collect information on the exposures and covariates of interest, including the use of mobile and cordless phones.

The analysis included 1148 cases with a diagnosis of glioma, and 2438 controls. When mobile-phone users were compared with people who reported no use of mobile or cordless phones, or exposure > 1 year before the reference date, an increased odds ratio was estimated (OR, 1.3; 95% CI, 1.1–1.6). The odds ratios increased progressively with increasing time since first mobile-phone use, and with increasing cumulative call time for the ordered categories of exposure duration (1–1000, 1001–2000, and > 2000 hours)

as follows: 1.2 (95% CI, 0.98–1.4), 1.5 (95% CI, 1.1–2.1), and 2.5 (95% CI, 1.8–3.5), respectively. Ipsilateral use of the mobile phone was associated with higher risk. Further, there were similar findings in relation to the use of cordless phones.

The Working Group noted several strengths of the study. It was the only study to assess exposure to cordless phones. By using registries for case ascertainment and population-based controls, and by achieving high response rates, the investigators minimized the potential for selection bias. However, the possibility of information bias cannot be excluded, and specific validation studies were not carried out in this population.

(v) *Comparison of the findings of INTERPHONE and the Swedish studies*

Because these two studies represent the most robust evidence on risk of tumours of the brain associated with wireless-phone use, the Working Group compared the methods and findings of the two studies, drawing on comparisons made by the Swedish investigators – Hardell and colleagues – published in 2008 and 2010. The data were collected in overlapping calendar periods (1997–2003 for Hardell *et al.*, with separate analyses available for 2000–2003, and 2000–2004 for INTERPHONE) and had some shared design features, e.g. collection of exposure information via a comprehensive set of questions. The studies differ in their general design, a single population-based study in the case of Hardell *et al.* and a multicentre study based in case ascertainment through hospitals, although with backup case ascertainment through cancer registries and other sources. The INTERPHONE study is probably more affected by selection bias due to differential participation between cases and controls, while the findings of both studies are subject to information bias, probably comparable in directionality. The generally null findings in the two large case–control studies for meningioma speak against information bias providing a full explanation for the associations reported for glioma.

Overall, the Working Group reviewed all the available evidence with regard to the use of wireless phones, including both mobile and cordless phones, and the risk of glioma. Time trends were considered, as were several early case–control studies and one cohort study. The evidence from these studies was considered less informative than the results of the INTERPHONE study and the Swedish case–control study. While both of these are susceptible to bias, the Working Group concluded that these findings could not be dismissed as reflecting bias alone, and that a causal interpretation was possible.

(b) Other tumours of the central nervous system: acoustic neuroma

Several early case–control studies and one cohort study from Denmark found no association. The major sources of evidence for acoustic neuroma were essentially the same as for glioma, as was the general pattern of findings. The case numbers, however, were substantially smaller than for glioma. The study from Sweden provided positive results with estimates quite similar to those observed for glioma. The pattern of findings from the INTERPHONE study also paralleled that for glioma, with a decreased risk overall, and an indication of a possibly increased risk in the stratum with the longest cumulative call time. A case–case study in Japan published in 2011 also found some evidence of an increased risk of acoustic neuroma associated with ipsilateral mobile-phone use.

In considering the evidence on acoustic neuroma, the Working Group considered the same methodological concerns as for glioma, but concluded that bias was not sufficient to explain the positive findings, particularly those of the study from Sweden.

(c) Meningioma

For meningioma, the same two studies mentioned above provided the key evidence. Overall, in each, the findings generally indicated no increase in risk.

(d) Leukaemia/lymphoma

The Working Group reviewed results of four studies of mobile-phone use and leukaemia, including two cohort and two case–control studies. Two population-based case–control studies addressed lymphoma. The Working Group found the evidence to be insufficient to reach a conclusion as to the potential association of mobile-phone use and either leukaemia or lymphoma.

(e) Other malignancies

Evidence to date does not point to a causal association of mobile-phone use with the various additional malignancies addressed, including ocular or cutaneous melanoma, cancer of the testis, cancer of the breast, or tumours of the parotid gland. With the exception of cancer of the breast, all these malignancies have been investigated explicitly in one or more case–control studies. No increased risk was observed for the above-mentioned sites in the 2006 report of the cohort study of Danish mobile-phone subscribers.

5.2.2 Occupational exposure

(a) Tumours of the brain

Four independent case–control studies investigated the association of occupational exposure to RF radiation with risk of brain tumours through specific assessment of individual RF exposure. One study was based on death certificates, the others were population-based studies. Two nested case–control studies (one from the USA and another from Canada and France) also investigated this association. For

the category of highest exposure in each study – determined with the best exposure measure reported, i.e. some form of expert assessment of work history in each case – the odds ratios were above unity, but with wide confidence intervals, thus suggesting that occupational exposure to RF radiation might increase the risk of tumours of the brain. Only two studies (a nested case–control analysis from the USA and a case–control study from Australia) provided dose–response assessments, and neither of these showed more than moderate evidence of a dose–response relationship. In addition, only two studies examined the possibility of confounding by other occupational exposures. A study from Germany adjusted the odds ratios for exposure to ionizing radiation and a study from the USA, based on death certificates, evaluated the sensitivity of the observed positive association of exposure to RF radiation with cancer of the brain with respect to confounding with known coexposures: solder fumes, lead and organic solvents. The observed odds ratio of 1.7 (95% CI, 1.1–2.7) for classification of RF exposure based on expert assessment decreased to 1.4 (95% CI, 0.7–3.1) when men exposed to solder fumes and lead were excluded from the exposed group, and dropped further to 0.4 when those exposed to organic solvents were also removed (although only two exposed cases and five exposed controls were left in the analysis). Chance and/or confounding cannot be ruled out as likely explanations for the observed association between occupational exposure to RF radiation and cancer of the brain.

Eight cohort studies (including the two nested case–control studies mentioned above) and a Polish cross-sectional study examined the relationship between occupational exposure to RF radiation and risk of tumours of the brain. Relative risks for the categories of highest exposure in all but three of the studies were close to or below unity. Among the three exceptions, one study from Italy was based on only one death from cancer of the brain; the cross-sectional

study from Poland showed a relative risk of 1.91 (95% CI, 1.08–3.47) but had methodological limitations that could explain the apparent increase in risk; and an American study had only a weakly increased relative risk (OR, 1.39; 95% CI, 0.93–2.00). On balance, therefore, the cohort studies did not suggest a positive association between exposure to RF radiation and cancer of the brain. Their exposure measures, however, were generally of less quality than those in the case–control studies.

While the association of exposure to RF radiation with cancer of the brain has been examined in a substantial number of studies, exposure misclassification and insufficient attention to possible confounding limit the interpretation of the findings. Thus, there is no clear indication of an association of occupational exposure to RF radiation with risk of cancer of the brain.

(b) *Leukaemia/lymphoma*

Seven cohort studies and one cross-sectional analysis examined the relationship between occupational exposure to RF radiation and risk of lymphoma and leukaemia. Most studies were based on small numbers of cases and limited exposure assessments. Increased standardized mortality ratios (SMRs) were seen for lymphomas and some leukaemias in a study of radio amateurs in the USA, but there was no association with an exposure-level surrogate (licence class). A substantially increased risk was also seen among Belgian military personnel who had worked with moveable radar, based on 11 cases, but exposure to RF radiation was not characterized individually and may have been confounded by ionizing radiation. In addition, follow-up of the cohort was problematic. The largest and most informative study was that of male United States navy veterans of the Korean War. Increased relative risks for leukaemia (in particular, acute myeloid and acute non-lymphocytic leukaemia) were seen among subjects with the highest compared with the lowest exposure. The highest odds ratio

was seen among technicians in aviation electronics, judged by the authors to be those with highest potential exposure. There was, however, no adjustment for potential confounders.

In summary, while there were weak suggestions of a possible increase in risk of leukaemia or lymphoma associated with occupational exposure to RF radiation, the limited exposure assessment and possible confounding make these results difficult to interpret.

(c) Other malignancies

Studies of occupational groups with potential exposure to RF radiation have addressed several additional types of malignancy including uveal melanoma, and cancers of the testis, breast, lung, and skin. The Working Group noted that these studies had methodological limitations and the results were inconsistent.

5.2.3 Environmental exposure

(a) Cancer of the brain

Ecological studies and case-control studies have been carried out to investigate potential associations of brain cancer with RF emissions from transmission antennae. These studies are generally limited by reliance on measures of geographical proximity to the antennae as an exposure surrogate. Substantial exposure misclassification is unavoidable.

Taken together, the ecological studies do not suggest a positive association between RF emissions from fixed transmission sources and cancer of the brain.

There have been five case-control studies of environmental exposure to RF radiation and risk of cancer of brain. Cohort studies have not been reported. In all of the case-control studies, exposure estimation was based on residential proximity to RF-transmitter antennae. Two of these studies used estimates of exposure based on recorded locations of subjects' residences relative to recorded locations of AM radio-transmitters

or mobile-phone base-station antennae. Neither found convincing indications of an increase in risk of brain cancer with increasing estimated exposure to RF radiation. A hospital-based study from France depended on subjects' recall of the proximity of their residence to a mobile-phone base station and found no evidence of an increased risk with closer proximity. However, the hospital-based controls may not represent exposure in the general population. The fourth study assessed proximity of subjects' beds to base stations of DECT cordless phones in the home. It found a weak and imprecise increase in risk of brain cancer associated with sleeping near a base station. Another study found high risks for brain, breast and other cancers associated with the place of residence where the highest power density from a nearby base-station antenna was measured, but the results were imprecise and based on only a few cases. Together, these studies provide no indication that environmental exposure to RF radiation increases the risk of brain tumours.

(b) Leukaemia/lymphoma

Ecological studies in which distance was taken as a proxy for exposure consistently showed a pattern of increased risk of adult and childhood leukaemia with closer proximity to the exposure source, while studies that used analytical designs and better exposure assessments (e.g. measured and modelled) showed no increased risk. In adults, the evidence of an association indicating increased risk was weak at most, and effect estimates were generally imprecise. There was no evidence of an increased risk of childhood leukaemia. Consequently, from the limited data available no conclusions could be drawn on the risk of leukaemia or lymphoma from environmental exposure to RF radiation.

(c) Other malignancies

The Working Group identified five studies that addressed other malignancies and environmental exposure to RF radiation, and found the available evidence uninformative.

5.3 Animal carcinogenicity data

Four classes of cancer bioassays in animals were reviewed and assessed by the Working Group. These studies involved a variety of animal models, exposure metrics, durations of exposure, and other criteria on which the evaluation of carcinogenicity was based.

Seven two-year cancer bioassays of RF radiation were reported, two in mice and five in rats; six studies were performed to examine the effects of exposure to mobile-phone RF metrics, and one study involved exposure to pulsed RF radiation. When compared with sham controls, no statistically significant increases in the incidence of benign or malignant neoplasms at any organ site were identified in animals exposed to mobile-phone RF radiation in any study. In the study with exposure to pulsed RF radiation, an increased incidence of total malignant tumours (all sites combined) was observed in rats; however, the Working Group considered this finding to be of limited biological significance since it resulted from pooling of non-significant changes in tumour incidence at several sites. Exposure to RF radiation did not increase total tumour incidence in any of the other six studies that were evaluated. The Working Group concluded that the results of the 2-year cancer bioassays provided no evidence that long-term exposure to RF radiation increases the incidence of any benign or malignant neoplasm in standard-bred mice or rats.

The Working Group evaluated twelve studies that used four different tumour-prone animal models; two of these studies demonstrated an increased incidence of tumours in animals

exposed to RF radiation. The first study with positive results demonstrated an increased incidence of lymphoma in *Eμ-Pim1*-transgenic mice exposed to GSM mobile-phone RF radiation at 900 MHz; however, two subsequent studies by other investigators using the same model system failed to confirm this finding. In the second study with positive results, an increased incidence of tumours of the mammary gland was observed in C3H/HeA mice exposed to RF radiation at 2450 MHz; although two later studies using the same exposure metric did not confirm this finding, these follow-on studies were performed at lower levels of exposure. The Working Group concluded that the results of studies in three tumour-prone animal models (the *Eμ-Pim1* mouse model of lymphoma, the AKR mouse model of lymphoma, and the *Patched1*^{+/-} mouse model of brain cancer) do not support the hypothesis that the incidence of tumours in the brain or lymphoid tissue would increase as a result of exposure to RF radiation.

The Working Group evaluated 16 studies of initiation and promotion that were performed with animal models of tumorigenesis in skin, mammary gland, brain, and lymphoid tissue. None of the five studies in models of skin cancer and none of the six studies in models of brain cancer showed an association with exposure to RF radiation. One of four studies with the model of mammary-gland tumour in Sprague-Dawley rats gave positive results; the other three studies – one with a nearly identical protocol – did not show an association, although they used the same experimental model and the same conditions of exposure to RF radiation. Likewise, the study with the model of lymphoma was negative. The Working Group concluded that the evidence from these studies of initiation and promotion failed to demonstrate a consistent pattern of enhancement of carcinogenesis by exposure to RF radiation in any of the tissues studied.

The Working Group evaluated six co-carcinogenesis studies involving five different animal models. Four positive responses were reported.

Two studies giving positive results, one in Wistar rats continuously exposed to drinking-water containing MX – a by-product of water disinfection – and another study in pregnant B6C3F₁ mice given a single dose of ethyl-nitrosourea, involved exposures to mobile-phone RF radiation at 900 and 1966 MHz, respectively. The other two studies with positive results involved coexposure of BALB/c mice to RF radiation at 2450 MHz and benzo[*a*]pyrene. Although the value of two of these studies was weakened by their unknown relevance to cancer in humans, the Working Group concluded that they did provide some additional evidence supporting the carcinogenicity of RF radiation in experimental animals.

5.4 Other relevant data

The data to evaluate the mechanisms by which RF radiation may cause or enhance carcinogenesis are extensive and diverse. Studies in humans from occupational cohorts, mobile-phone users and controlled exposures in experimental settings provide information on effects in various tissues, including blood and brain. Studies in animals have been focused on a variety of organs and tissues. Assays *in vitro* in human cells, other mammalian cells, and cells from other organisms provide the largest set of data from which to evaluate mechanisms. Many studies were confounded by significant increases in the temperature of the cells, leading to thermal effects that could not be dissociated from non-thermal RF-induced changes. The conclusions presented in this section for results *in vivo* and *in vitro* pertain only to those studies for which the Working Group concluded that thermal confounding did not occur.

5.4.1 Genetic and related effects of exposure

Multiple studies in humans were conducted on the possible genetic damage associated with exposure to RF radiation. Most of these studies were of occupational exposure and the others evaluated mobile-phone users. Several common exposures to the general population that are likely to be confounders were generally not considered, including tobacco use and age. In addition, other occupational exposures that might have contributed to the findings were rarely discussed. Most of the occupational studies that suggested a positive association of the effect with exposure to RF radiation involved workers from the same facility, included small numbers of subjects, and provided no indication of the extent to which the same individuals were sampled in multiple studies. Virtually all the large studies did not show an association with exposure to RF radiation, for any type of genetic damage. Finally, there were methodological flaws and weaknesses in reporting in many studies, including the failure to actually measure exposure to RF radiation, the use of small numbers of cells for evaluating genetic damage, the failure to use proper controls while culturing cells, incomplete reporting, and improper interpretation of results.

A few studies in *Drosophila* that addressed mutagenicity after exposure to RF radiation gave negative results.

Approximately half of the laboratory studies of genetic damage in mammalian systems, generally rats and mice, had limitations related to reporting on the exposure system, small sample sizes and exposures that induced thermal effects, or that were so low as to be no challenge to the animals. Of the remaining studies, many were satisfactory and of comparable quality, but showed contradictory results. Some were attempts to repeat original laboratory findings. Also these studies provided mixed and sometimes contradictory results. Some of the discrepancies could be due to differences in species or

exposure conditions, but others were in direct contrast.

Roughly half of the studies of human cells *in vitro* were done in lymphocytes cultured from the blood of donors. Short-term, high-intensity exposures to RF radiation resulted in consistently positive results for DNA damage, but the Working Group felt that thermal effects were the likely cause of these effects. A large number of studies on DNA strand breaks and the studies on sister chromatid exchange generally gave negative results. Exposures to RF radiation in the non-thermal range also generally gave negative results.

The remaining in-vitro studies with human cells and the in-vitro studies with non-human cells also involved short-term, high-intensity exposures that consistently gave positive results for DNA damage. The Working Group considered that these results were likely due to thermal effects. There were acceptable reports showing both positive and negative results in the remaining studies with exposures in the non-thermal range. In addition, studies showing aneuploidy and spindle disturbances in human-hamster hybrid A_L cells, and studies at low exposures showing DNA single-strand breaks were of concern. While RF radiation has insufficient energy to produce these types of direct genetic damage, other changes such as oxidative stress and production of reactive oxygen species may explain these results.

The remaining few studies that gave positive results for genetic damage at lower doses could not be replicated after multiple attempts in different laboratories, raising serious questions regarding the original findings. A single study showing altered microtubule structures at low exposures remains a concern.

Overall, the Working Group concluded that there was weak evidence that RF radiation is genotoxic, and no evidence for the mutagenicity of RF radiation.

5.4.2 Reaction of the immune system after exposure

Several studies assessed the effects of exposure to RF radiation on indicators of immune function in humans. In two studies, increased concentrations of some immunoglobulins (Ig) and changes in numbers of lymphocytes (T8, natural killer [NK] cells) were observed in blood samples from radar operators and workers at television-transmission stations, but the results were variable and the alterations seemed to be within the normal variation. Two studies among workers exposed to very high frequency RF radiation showed a significant increase in IgG and IgM, and a higher number of NK cells, respectively. Patients with atopic eczema dermatitis showed an increase in allergen-provoked production of IgE when they had been exposed to RF radiation from a mobile phone. Many of these studies used small numbers of subjects and generally did not control for possible confounders.

The available evidence from numerous experimental studies *in vivo* that aimed to assess effects of short-term and prolonged low-level exposure to RF radiation on function and status of the immune system, clearly indicates that various shifts in number and/or activity of immunocompetent cells are possible. However, in some cases the same lymphocyte functions are reported to be weakened or enhanced in different single experiments, despite exposures to RF radiation at similar intensities and under similar exposure conditions. Short-term exposure to weak RF fields may temporarily stimulate certain humoral or cellular immune functions, while prolonged irradiation inhibits the same functions. Thus, even though there are indications that changes are occurring, the relevance of these observations in relation to carcinogenicity is unclear.

The effects of RF radiation on various types of human lymphocytes *in vitro* are variable and depend on the mitotic state of the cells during

exposure. A difference was reported between the effects of exposure to continuous-wave and pulsed-wave RF radiation, the latter preferentially stimulating the immunogenic and pro-inflammatory activity of monocytes. Many of these studies had weaknesses in the description of experimental procedures and from lack of detail on dosimetry.

Overall, the Working Group concluded that there was insufficient evidence to determine that alterations in immune function induced by exposure to RF radiation affect carcinogenesis in humans.

5.4.3 Effects on genes, proteins and signalling pathways

No studies assessing gene expression in humans exposed to RF radiation were identified, and only one pilot study assessed protein changes in exposed human subjects.

Nearly 30 studies investigated gene/protein changes in rodents exposed to RF radiation. Many of these studies were unreliable due to deficiencies in the exposure system or methodological shortcomings. The data from the remaining studies are limited and present mixed results with no consistent pattern of response.

A large number of studies have assessed the ability of RF radiation to affect gene/protein expression and protein activation in human-derived cell lines *in vitro*. The majority of studies assessing effects of RF radiation on expression and activity of heat-shock proteins reported no effect. A limited number of studies assessed the ability of RF radiation to influence the activity of signal-transduction pathways in human cells *in vitro*. Three studies found changes in MAPK signalling, while another did not. The role of reactive oxygen species in mediating these responses is unclear.

A total of 16 studies used high-throughput genomics/proteomics approaches to evaluate the effect of exposure to RF radiation on human cell lines *in vitro*. Many of these studies had

serious methodological shortcomings related to poor exposure conditions, inadequate statistical analysis, and lack of validation of alternative approaches. The remaining data were limited with no consistent pattern of response, but some studies demonstrated changes in both gene and protein expression, for some proteins in some cell lines.

On the basis of the above considerations, the Working Group concluded that data from studies of genes, proteins and changes in cellular signalling show weak evidence of effects from RF radiation, but did not provide mechanistic information relevant to carcinogenesis in humans.

5.4.4 Other mechanistic end-points

Several potential changes resulting from exposure to RF radiation are summarized here. With the exception of changes in cerebral blood flow, many of the other studies reviewed by the Working Group provided conflicting, negative or very limited information, which made it difficult to draw conclusions, especially in relation to carcinogenesis. These studies focused on electrical activity in the brain, cognitive function, general sensitivity to RF radiation and alterations in brain biochemistry. Even though the relationship between alterations in cerebral blood flow during exposure to RF radiation cannot be directly related to carcinogenesis, the Working Group concluded that the available data were sufficiently consistent to identify them as important findings.

Some studies were conducted in experimental animals to explore the possibility that exposure to RF radiation *in vivo* may induce the production of reactive oxygen species in multiple organs, most frequently brain, but also kidney, liver and eye. Markers of oxidative stress included increases in the concentration of malondialdehyde (related to lipid peroxidation) and nitric oxide, enhanced activities of antioxidant enzymes (superoxide dismutase, catalase, glutathione peroxidase) and pro-oxidant enzymes, and reductions in

glutathione. Many of these studies are weakened by methodological shortcomings in design, such as absence of sham-exposed or cage-control groups, use of mobile phones as the exposure source, and lack of dosimetry.

A few studies in human cells *in vitro* evaluated the possible role of exposure to RF radiation in altering levels of intracellular oxidants or activities of antioxidant enzymes. One study showed a marginal effect, while other studies demonstrated an increase in activity with increasing exposures. There were not enough studies to make a reasonable assessment of the consistency of these findings. Additional studies addressed this issue in in-vitro systems with non-human cells. While most of these did not find changes, one study evaluated the formation of DNA adducts from reactive oxygen species (8-hydroxy-deoxyguanosine) and was able to demonstrate reversal of this effect by melatonin. While the overall evidence was inconclusive, the results from in-vitro studies with animal models raise some concern.

Overall, the Working Group concluded that there was weak evidence that exposure to RF radiation affects oxidative stress and alters the levels of reactive oxygen species.

Numerous studies have assessed the function of the blood–brain barrier in rodents exposed to RF radiation at various intensities. Consistent results from one laboratory suggest an increase in the permeability of the blood–brain barrier, but the majority of the studies, many of which aimed at replicating published results, failed to observe any effect on this point from exposure to either continuous or pulsed RF radiation. The evidence that exposure to RF radiation alters the blood–brain barrier was considered weak.

A few studies dealt with alterations induced by RF radiation in cell differentiation or induction of apoptosis in the brain or other organs. While most of the studies showed an association, the Working Group was not convinced that these data were of sufficient scientific rigour to assess

apoptotic effects in these organs. An additional 14 studies focused on apoptosis in cultured human cells. Only two studies demonstrated an increase in apoptosis: one compared the results observed in treated cells with controls that were not subject to the same conditions as the exposed cells, while thermal effects may have had an impact in the other study. Finally, other in-vitro studies with non-human cells gave essentially negative results, with the exception of one study that demonstrated mixed results. The evidence that exposure to RF radiation alters apoptosis was considered weak.

Multiple assays *in vitro* were conducted to test proliferation of primary cells or established cell lines by analysis of cell-cycle progression and thymidine uptake, after exposure to various intensities of RF radiation at various time intervals. Many of these studies used small sample sizes and description of experimental details was lacking in several cases. Studies with positive results showed increases and decreases in cellular replication, and no consistent pattern could be discerned. The evidence that RF radiation alters cellular replication was considered weak.

Ornithine decarboxylase is an enzyme involved in the metabolism of polyamines, which are critical components of cellular replication and differentiation processes. The activity of this enzyme was the object of several studies *in vitro* in human and animal cells exposed to GSM900 and GSM1800 signals. Some of these studies showed significantly increased ornithine decarboxylase activity. The result of one study suggested that ornithine decarboxylase activities may be reduced. It was unclear how these changes in activity relate to human cancer. There was weak evidence from in-vitro studies that exposure to RF radiation alters ornithine decarboxylase activity.

The evidence that exposure to RF radiation, at intensities below the level of thermal effects, may produce oxidative stress in brain tissue and may affect neural functions was considered weak.

6. EVALUATION

6.1 Cancer in humans

There is *limited evidence* in humans for the carcinogenicity of radiofrequency radiation. Positive associations have been observed between exposure to radiofrequency radiation from wireless phones and glioma, and acoustic neuroma.

6.2 Cancer in experimental animals

There is *limited evidence* in experimental animals for the carcinogenicity of radiofrequency radiation.

6.3 Overall evaluation

Radiofrequency electromagnetic fields are *possibly carcinogenic to humans (Group 2B)*.

6.4 Rationale for the evaluation of the epidemiological evidence

The human epidemiological evidence was mixed. Several small early case-control studies were considered to be largely uninformative. A large cohort study showed no increase in risk of relevant tumours, but it lacked information on level of mobile-phone use and there were several potential sources of misclassification of exposure. The bulk of evidence came from reports of the INTERPHONE study, a very large international, multicentre case-control study and a separate large case-control study from Sweden on gliomas and meningiomas of the brain and acoustic neuromas. While affected by selection bias and information bias to varying degrees, these studies showed an association between

glioma and acoustic neuroma and mobile-phone use; specifically in people with highest cumulative use of mobile phones, in people who had used mobile phones on the same side of the head as that on which their tumour developed, and in people whose tumour was in the temporal lobe of the brain (the area of the brain that is most exposed to RF radiation when a wireless phone is used at the ear). The Swedish study found similar results for cordless phones. The comparative weakness of the associations in the INTERPHONE study and inconsistencies between its results and those of the Swedish study led to the evaluation of *limited evidence* for glioma and acoustic neuroma, as decided by the majority of the members of the Working Group. A small, recently published Japanese case-control study, which also observed an association of acoustic neuroma with mobile-phone use, contributed to the evaluation of *limited evidence* for acoustic neuroma.

There was, however, a minority opinion that current evidence in humans was *inadequate*, therefore permitting no conclusion about a causal association. This minority saw inconsistency between the two case-control studies and a lack of exposure-response relationship in the INTERPHONE study. The minority also pointed to the fact that no increase in rates of glioma or acoustic neuroma was seen in a nationwide Danish cohort study, and that up to now, reported time trends in incidence rates of glioma have not shown a trend parallel to time trends in mobile-phone use.

GLOSSARY

Antenna: Device that serves as a transducer between a guided wave (e.g. via a coaxial cable) and a free space wave, or *vice versa*. It can be used either to emit or to receive a radio signal.

Base station: Wireless communications station installed at a fixed location and used to transmit and receive radio signals to and from mobile-phone users. Also used for DECT phones at home.

Cell phone: See “Mobile phone”.

Cellular radio network: Fixed infrastructure comprising multiple base stations deployed across a wide geographical area such that mobile-phone users are able to communicate via the base stations, with the radio signals associated with their calls being transmitted from one base station to another as the users move across cell boundaries.

Conductivity: The ratio of the conduction-current density in a medium to the electric field strength. The unit of conductivity is siemens per metre (S/m).

Cordless phone: (DECT, portable phone) A wireless telephone that communicates via radio waves with a base station connected to a fixed telephone line, usually within a limited range of its base station. The base station is on the premises of the owner, and attached to the wired telephone network in the same way as a corded telephone.

DECT phone: See “Cordless phone”

Effective radiated power (ERP) or equivalent radiated power: is a standardized theoretical measurement of radiofrequency (RF) energy using the SI unit watts, and is determined by subtracting system losses and adding system gains. ERP is similar to EIRP (see below), but may use some other reference antenna than an isotropic antenna, e.g. a half dipole.

Electric-field strength (E): Magnitude of a field vector at a point that represents the force (F) on a small test charge (q) divided by the charge:

$$\vec{E} = \frac{\vec{F}}{q}$$

The magnetic field strength is expressed in units of volt per metre (V/m).

Equivalent isotropically radiated power (EIRP) or effective isotropically radiated power: The amount of power that a theoretical isotropic antenna (which evenly distributes power in all directions) would emit to produce the peak power density observed in the direction of maximum antenna gain. EIRP can take into account the losses in transmission line and connectors and includes the gain of antenna. The EIRP is often expressed in terms of decibels over a reference power emitted by an isotropic radiator with an equivalent signal strength. The EIRP allows comparisons between different emitters regardless of type, size or form. From the EIRP, and with knowledge of a real antenna’s gain, it

is possible to calculate real values for power and field strength.

Equivalent plane-wave power density (plane-wave equivalent power density) (S): A commonly used term associated with any electromagnetic wave, equal in magnitude to the power density of a plane wave having the same electric- (E) or magnetic- (H) field strength. Specifically, the normalized value of the square of the electric- or the magnetic-field strength at a point in the near field of a radiating source. The unit of equivalent plane-wave power density (according to the International System of Units, SI) is the watt per square metre (W/m²) and is computed as follows:

$$S = \frac{|E|^2}{\eta} = \eta|H|^2$$

where:

E and *H* are the root-mean-square (rms) values of the electric- and magnetic-field strengths, respectively

η is the wave impedance ($\cong 377$ ohms in free space).

Note that most field-survey equipment uses this relationship, although it does not apply to the near field. In case of exposure assessment, the independent measurement of *E rms* (or $|E|^2$) and *H rms* (or $|H|^2$) is preferred.

Synonym: equivalent plane-wave power flux density.

Far-field region and near-field region: The far-field region is defined when the fields can be well approximated by the radiating fields, i.e. the E-field vector is perpendicular to the H-field vector, and both are orthogonal to the direction of propagation whereby the ratio of the amplitudes of the E- and H-fields is 377 ohm.

The near-field region is when the above conditions are not met, i.e. when the field is dominated by reactive field components.

Frequency and wavelength: The intensity of electric and magnetic fields can vary periodically over time and space, following a sinusoidal function. In the time domain, the number of cycles of oscillation per second is defined as the frequency, *f*, of the field and is expressed in hertz (Hz). In the spatial domain, the distance between two peaks of one oscillation cycle is called the wavelength. In free space, this is equivalent to:

$$\lambda = \frac{c}{f}$$

where:

c is the velocity of light ($\approx 3.10^8$ m/s).

Magnetic-field strength (H): The magnitude of a field vector in a point that results in a force (F) on a charge *q* moving with the velocity *v*:

$$F = q (v \times \mu H)$$

The magnetic-field strength is expressed in units of ampere per metre (A/m).

Magnetic-flux density (B): The magnitude of a field vector that is equal to the magnetic field strength *H* multiplied by the permeability (μ) of the medium:

$$B = \mu H$$

Magnetic-flux density is expressed in units of tesla (T).

Mobile phone: (cell phone, hand-held phone) Electronic device used to make and receive phone calls across a wide geographical area allowing the user to be mobile. A mobile phone is connected to a cellular network provided by a mobile-network operator.

Modulation: The process, or result of the process, whereby some characteristic of one wave is varied in accordance with another wave or signal. There are three canonical modulation types:

- AM (amplitude modulation): information is imparted to an electromagnetic wave by varying its amplitude
- FM (frequency modulation): information is imparted to an electromagnetic wave by varying its frequency
- ϕ M (phase modulation): information is imparted to an electromagnetic wave by varying its phase

FM and ϕ M are actually closely related to each other, e.g. both can be expressed mathematically in terms of a phase modulation.

Multiple access, or channel multiple access:

Multiple-access methods are required to allow multiple devices to operate simultaneously. The following multiple-access methods are available for transmitting a set of individual data streams:

- FDMA: frequency-division multiple access splits the communication spectrum into different frequency domain bands that are assigned to the different data streams.
- TDMA: time-division multiple access splits the communication spectrum into periodically repetitive time slots, each terminal or data stream has a fixed periodic time slot during which data may be transmitted.
- CDMA: code-division multiple access allows multiple transmitters to send data simultaneously, theoretically, in the same frequency and time-domain channels. Communication channels are separated in the code domain by multiplying (spreading) the data streams with mutually orthogonal code vectors. Applying the same code vectors at the receiver allows separation of multiple simultaneous data streams due to the orthogonality of the codes.
- SDMA: space-division multiple access separates different data streams in space.

A prominent example is directional radio systems.

In principle, the same multiple-access methods can be used to divide the forward and return data stream between two terminals. In practice however only time-division duplex (TDD) and frequency-division duplex (FDD) are applied.

Peak spatial SAR (psSAR): Peak spatial SAR values describe the peak SAR of all sSAR (See specific absorption rate [SAR] and spatially averaged SAR [sSAR]).

Peak-to-average power ratio (PAPR): The probability of peak signal power exceeding the average power level by 0.1%. In the case of non-statistical disruptions, PAPR is equivalent to the crest factor, i.e. 2 for a sinusoidal signal, 8.7 for GSM, 3.1–3.3 for UMTS-FDD, 10–20 for WLAN, etc. In the case of pulsed signals, the peak pulse amplitude is PAPR multiplied by the average power.

Penetration depth: For a plane electromagnetic wave incident on the boundary of a medium, the distance from the boundary into the medium along the direction of propagation in the medium, at which the field strengths of the wave have been reduced to $1/e$ (around 37%) of their boundary values. Penetration depth is expressed in metres (m).

Permittivity: The ratio of the electric-flux density in a medium to the electric-field strength at a point. The permittivity of biological tissues is dependent on frequency. Permittivity is expressed in units of farad per metre (F/m).

Polarization: The property of a radiated electromagnetic wave describing the time-varying direction and amplitude of the electric-field vector; specifically, the figure traced as a function of time by the extremity of the E-field vector at a fixed location in space, as observed along the direction of propagation.

Power density (Pd): The radiant power incident perpendicular to a surface, divided by the area of the surface. The power density is expressed in units of watt per square metre (W/m²). Power density can be determined from the field strengths as follows:

$$P_d = E \times H = \frac{E^2}{377\Omega} = 377\Omega H^2$$

Also written as:

$$P_d = E \times H = E^2|377\Omega = 377\Omega H^2$$

Radiation: The emission and propagation of energy in the form of waves or particles through space.

Radiofrequency: Any frequency in the range of 30 MHz to 300 GHz.

Receiver: A device that detects radio signals and extracts useful information that has been encoded onto them through modulation, such as speech, music, data or pictures.

Resonance: The tendency of an object to oscillate with a larger amplitude at certain frequencies.

Root-mean-square (rms): The rms value or effective value is the square root of the mean of the squares of a continuous function:

$$f_{rms} = \sqrt{\frac{1}{T_2 - T_1} \int_{T_1}^{T_2} [f(t)]^2 dt}$$

where:

T is period

t is time

f is frequency

The rms values are important in the context of expressing exposure values averaged over time (see also specific absorption rate, SAR).

Root-sum-square (rss): The rss value is the root of the sum of the squares of the components of a vector.

Sidelobes: Antennae designed to radiate a main beam in particular angular direction also produce weaker beams known as sidelobes in other angular directions.

Spatially averaged SAR (sSAR): Spatially averaged SAR (sSAR) values have been defined to better characterize SAR with respect to potential hazards. Technically, each location of the body is represented with a spatially averaged SAR. Different definitions have been proposed for standard settings and are commonly applied:

- **sSAR-1 g:** spatially averaged SAR values over a mass of 1 g of tissue in the shape of a cube. Special evaluation conditions are applied in case of air interfaces (IEEE C95.3). In practice, each local SAR value in the body is represented by the sSAR-1 g value whereby the cube is grown symmetrically around that location. At higher frequencies, sSAR-1 g is approximately twice the value of sSAR-10 g due to the reduced penetration depth.
- **sSAR-10 g:** spatially averaged SAR values over a mass of 10 g of tissue in the shape of a cube.
- **sSAR-10 g c:** spatially averaged SAR values over a mass of 10 g of contiguous tissue.

Specific absorption rate (SAR): The time derivative of the incremental energy (dW) absorbed by (dissipated in) an incremental mass (dm) contained in a volume element (dV) of given density (ρ):

$$SAR = \frac{d}{dt} \left(\frac{dW}{dm} \right) = \frac{d}{dt} \left(\frac{dW}{\rho dV} \right)$$

The SI unit of SAR is the watt per kilogram (W/kg).

NOTE: SAR can be related to the electric field at a point by:

$$SAR = \frac{\sigma|E|^2}{\rho}$$

where:

σ is conductivity of the tissue (S/m)

ρ is mass density of the tissue (kg/m³)

E is rms electric field strength in tissue (V/m)

NOTE: SAR can be related to the increase in temperature at a point by:

$$SAR = \left. \frac{c\Delta T}{\Delta t} \right|_{t=0}$$

where:

ΔT is the change in temperature (°C)

Δt is the duration of exposure (s)

c is the specific heat capacity (J/kg °C)

This assumes that measurements are made under “ideal” non-thermodynamic circumstances, i.e. no heat loss by thermal diffusion, radiation, or thermoregulation (blood flow, sweating, etc.). Therefore, the third equation is only valid if the exposed body is in thermal equilibrium or a steady thermal state at the beginning of the exposure and either heat exchange processes can be neglected during the measurement interval or the processes are known and corrected such that dT can be correspondingly corrected.

In other words, SAR is proportional to the absorbed energy, square of the induced E-fields or induced current density. However, SAR is not directly proportional to the induced magnetic field.

Specific tissue-averaged SAR (stSAR): The total electromagnetic power absorbed by an organ or specific tissue.

Standing waves: Standing waves are formed where RF fields are contained by reflection back and forth. Energy is stored in the space where reflection occurs, which leads to high field

strengths that are not associated with radiation. Fields associated with standing waves generally deposit much less energy in the body tissues than radiation fields of the same strength.

Time-averaged SAR or temporal-averaged SAR: SAR is usually reported as time-averaged SAR, either over the periodicity of the signal or over any 6 minutes.

Transceiver: A device containing both a transmitter and a receiver, such that it forms one terminal in a duplex communications link.

Transmitter: A device that generates and amplifies a carrier wave, modulates it to carry information, and radiates the resulting signal from an antenna, such that it can be received elsewhere.

UMTS (Universal Mobile Telecommunications System): a third-generation mobile telecommunications technology that uses digitally encoded signals to enable user access.

Whole-body SAR or whole-body averaged SAR (wbSAR): The whole-body SAR is the total electromagnetic power absorbed by a body divided by its mass.

Wi-Fi: a wireless transmission technique for use in local area networks that works in 2.4 GHz and 5 GHz bands. It is a registered trademark of the Wi-Fi Alliance.

WLAN (wireless local area network): a short-range wireless data communications network linking two or more devices.

WPAN (wireless personal area networks): a short-range wireless communications network for personal devices located near to the individual, e.g. Bluetooth.

LIST OF ABBREVIATIONS

AMPS	advanced mobile phone system
CMB	cosmic microwave background
CDMA	code-division multiple access
CW	continuous wave
DAB	digital audio broadcasting
D-AMPS	digital advanced mobile phone system
DECT	digital enhanced cordless telecommunications
DCS	digital cellular system
DMH	dimethylhydrazine
DTX	discontinuous transmission
EIRP	equivalent isotropically radiated power
EMF	electromagnetic field
ENU	<i>N</i> -ethyl- <i>N</i> -nitrosourea
ERP	effective radiated power
FDD	frequency-division duplex
FDMA	frequency-division multiple access
FDTD	finite-difference time-domain
FEM	finite-element method
GPRS	general packet radio service
GSH-Px	glutathione peroxidase
GSM	Global System for Mobile communications
HAN	home area network
HF	high frequency
ICNIRP	International Council on Non-Ionizing Radiation Protection
iDEN	integrated Digital Enhanced Network
IRP	spherically-integrated radiated power
ISM	industrial, scientific and medical
LAN	local area network
LF	low frequency
LPS	lipopolysaccharide
LTE	long-term evolution
MF	medium frequency
MoM	method of moment
MPE	maximum permissible exposures
MRI	magnetic resonance imaging

MX	3-chloro-4-(dichloromethyl)-5-hydroxy-2(5H)-furanone
NAC	<i>N</i> -acetyl cysteine
NO	nitric oxide
ODC	ornithine decarboxylase
OFDM	orthogonal frequency-division multiplexing
PCI	peripheral component interconnect
PDC	personal digital cellular
PHA	phytohaemagglutinin
PMA	phorbol 12-myristate 13-acetate
PMR	private mobile radio
PTT	push-to-talk
pps	pulses per second
PVC	polyvinyl chloride
PW	pulsed wave
MMC	mitomycin C
NMT	Nordic Mobile Telephony
RF	radiofrequency
ROS	reactive oxygen species
RTL	radial transmission line
RT-PCR	reverse-transcriptase polymerase chain reaction
SAM	specific anthropometric mannequin
SAR	specific absorption rate
SD	standard deviation
SMS	short message service
SOD	superoxide dismutase
TAC	total antioxidant capacity
TACS	total-access communication systems
TCSE	total cumulative specific energy
TDMA	time-division multiple access
TEM	transverse electromagnetic
TETRA	Terrestrial Trunked Radio
TNF	tumour necrosis factor
TPA	12- <i>O</i> -tetradecanoylphorbol-13-acetate
UMTS	Universal Mobile Telecommunications System
<i>vs</i>	<i>versus</i>
WCDMA	wideband code-division multiple access
Wi-Fi	standard wireless local area network (WLAN) technology
WiMax	worldwide interoperability for microwave access
WLAN	wireless local area network
XO	xanthine oxidase

CUMULATIVE CROSS INDEX TO IARC MONOGRAPHS

The volume and year of publication are given. References to corrigenda are given in parentheses.

A

A- α -C	40 (1986); Suppl. 7 (1987)
Acenaphthene	92 (2010)
Acenaphthylene	92 (2010)
Acetaldehyde	36 (1985) (corr. 42); Suppl. 7 (1987); 71 (1999)
Acetaldehyde associated with the consumption of alcoholic beverages	100E (2012)
Acetaldehyde formylmethylhydrazone (see Gyromitrin)	
Acetamide	7 (1974); Suppl. 7 (1987); 71 (1999)
Acetaminophen (see Paracetamol)	
Aciclovir	76 (2000)
Acid mists (see Sulfuric acid and other strong inorganic acids, occupational exposures to mists and vapours from)	
Acridine orange	16 (1978); Suppl. 7 (1987)
Acriflavium chloride	13 (1977); Suppl. 7 (1987)
Acrolein	19 (1979); 36 (1985); Suppl. 7 (1987); 63 (1995) (corr. 65)
Acrylamide	39 (1986); Suppl. 7 (1987); 60 (1994)
Acrylic acid	19 (1979); Suppl. 7 (1987); 71 (1999)
Acrylic fibres	19 (1979); Suppl. 7 (1987)
Acrylonitrile	19 (1979); Suppl. 7 (1987); 71 (1999)
Acrylonitrile-butadiene-styrene copolymers	19 (1979); Suppl. 7 (1987)
Actinolite (see Asbestos)	
Actinomycin D (see also Actinomycins)	Suppl. 7 (1987)
Actinomycins	10 (1976) (corr. 42)
Adriamycin	10 (1976); Suppl. 7 (1987)
AF-2	31 (1983); Suppl. 7 (1987)
Aflatoxins	1 (1972) (corr. 42); 10 (1976); Suppl. 7 (1987); 56 (1993); 82 (2002); 100F (2012)
Aflatoxin B ₁ (see Aflatoxins)	
Aflatoxin B ₂ (see Aflatoxins)	

Aflatoxin G ₁ (see Aflatoxins)	
Aflatoxin G ₂ (see Aflatoxins)	
Aflatoxin M ₁ (see Aflatoxins)	
Agaritine.....	31 (1983); Suppl. 7 (1987)
Alcohol consumption	44 (1988); 96 (2010); 100E (2012)
Aldicarb.....	53 (1991)
Aldrin.....	5 (1974); Suppl. 7 (1987)
Allyl chloride.....	36 (1985); Suppl. 7 (1987); 71 (1999)
Allyl isothiocyanate	36 (1985); Suppl. 7 (1987); 73 (1999)
Allyl isovalerate	36 (1985); Suppl. 7 (1987); 71 (1999)
Aluminium production	34 (1984); Suppl. 7 (1987); 92 (2010); 100F (2012)
Amaranth.....	8 (1975); Suppl. 7 (1987)
5-Aminoacenaphthene.....	16 (1978); Suppl. 7 (1987)
2-Aminoanthraquinone	27 (1982); Suppl. 7 (1987)
<i>para</i> -Aminoazobenzene.....	8 (1975); Suppl. 7 (1987)
<i>ortho</i> -Aminoazotoluene.....	8 (1975) (corr. 42); Suppl. 7 (1987)
<i>para</i> -Aminobenzoic acid.....	16 (1978); Suppl. 7 (1987)
4-Aminobiphenyl	1 (1972) (corr. 42); Suppl. 7 (1987); 100F (2012)
1-Amino-2,4-dibromoanthraquinone	101 (2012)
2-Amino-3,4-dimethylimidazo[4,5- <i>f</i>]quinoline (see MeIQ)	
2-Amino-3,8-dimethylimidazo[4,5- <i>f</i>]quinoxaline (see MeIQx)	
3-Amino-1,4-dimethyl-5H-pyrido[4,3- <i>b</i>]indole (see Trp-P-1)	
2-Aminodipyrido[1,2- <i>a</i> :3',2'- <i>d</i>]imidazole (see Glu-P-2)	
1-Amino-2-methylantraquinone.....	27 (1982); Suppl. 7 (1987)
2-Amino-3-methylimidazo[4,5- <i>f</i>]quinoline (see IQ)	
2-Amino-6-methyldipyrido[1,2- <i>a</i> :3',2'- <i>d</i>]imidazole (see Glu-P-1)	
2-Amino-1-methyl-6-phenylimidazo[4,5- <i>b</i>]pyridine (see PhIP)	
2-Amino-3-methyl-9H-pyrido[2,3- <i>b</i>]indole (see MeA- α -C)	
3-Amino-1-methyl-5H-pyrido[4,3- <i>b</i>]indole (see Trp-P-2)	
2-Amino-5-(5-nitro-2-furyl)-1,3,4-thiadiazole	7 (1974); Suppl. 7 (1987)
2-Amino-4-nitrophenol.....	57 (1993)
2-Amino-5-nitrophenol.....	57 (1993)
4-Amino-2-nitrophenol.....	16 (1978); Suppl. 7 (1987)
2-Amino-5-nitrothiazole.....	31 (1983); Suppl. 7 (1987)
2-Amino-9H-pyrido[2,3- <i>b</i>]indole (see A- α -C)	
11-Aminoundecanoic acid.....	39 (1986); Suppl. 7 (1987)
Amitrole	7 (1974); 41 (1986) (corr. 52); Suppl. 7 (1987); 79 (2001)
Ammonium potassium selenide (see Selenium and selenium compounds)	
Amorphous silica (see also Silica)	42 (1987); Suppl. 7 (1987); 68 (1997) (corr. 81)
Amosite (see Asbestos)	
Ampicillin.....	50 (1990)
Amsacrine	76 (2000)
Anabolic steroids (see Androgenic [anabolic] steroids)	
Anaesthetics, volatile	11 (1976); Suppl. 7 (1987)

- Analgesic mixtures containing phenacetin (see also Phenacetin)..... Suppl. 7 (1987); 100A (2012)
- Androgenic (anabolic) steroids Suppl. 7 (1987)
- Angelicin and some synthetic derivatives (see also Angelicins).....40 (1986)
- Angelicin plus ultraviolet radiation Suppl. 7 (1987)
(see also Angelicin and some synthetic derivatives)
- Angelicins..... Suppl. 7 (1987)
- Aniline..... 4 (1974) (corr. 42); 27 (1982); Suppl. 7 (1987)
- ortho*-Anisidine.....27 (1982); Suppl. 7 (1987); 73 (1999)
- para*-Anisidine 27 (1982); Suppl. 7 (1987)
- Anthanthrene 32 (1983); Suppl. 7 (1987); 92 (2010)
- Anthophyllite (see Asbestos)
- Anthracene 32 (1983); Suppl. 7 (1987); 92 (2010)
- Anthranilic acid 16 (1978); Suppl. 7 (1987)
- Anthraquinone.....101 (2012)
- Anthraquinones..... 82 (2002)
- Antimony trioxide 47 (1989)
- Antimony trisulfide.....47 (1989)
- ANTU (see 1-Naphthylthiourea)
- Apholate..... 9 (1975); Suppl. 7 (1987)
- para*-Aramid fibrils68 (1997)
- Aramite® 5 (1974); Suppl. 7 (1987)
- Areca nut (see also Betel quid) 85 (2004); 100E (2012)
- Aristolochia species (see also Traditional herbal medicines) 82 (2002); 100A (2012)
- Aristolochic acids..... 82 (2002); 100A (2012)
- Arsanilic acid (see Arsenic and arsenic compounds)
- Arsenic and arsenic compounds 1 (1972); 2 (1973); 23 (1980); Suppl. 7 (1987); 100C (2012)
- Arsenic in drinking-water.....84 (2004)
- Arsenic pentoxide (see Arsenic and arsenic compounds)
- Arsenic trioxide (see Arsenic in drinking-water)
- Arsenic trisulfide (see Arsenic in drinking-water)
- Arsine (see Arsenic and arsenic compounds)
- Asbestos..... 2 (1973) (corr. 42); 14 (1977) (corr. 42); Suppl. 7 (1987) (corr. 45); 100C (2012)
- Atrazine.....53 (1991); 73 (1999)
- Attapulgit (see Palygorskite)
- Auramine, technical-grade.....1 (1972) (corr. 42); Suppl. 7 (1987); 100F (2012)
- Auramine, manufacture of (see also Auramine, technical-grade)Suppl. 7 (1987); 100F (2012)
- Aurothioglucose 13 (1977); Suppl. 7 (1987)
- Azacitidine.....26 (1981); Suppl. 7 (1987); 50 (1990)
- 5-Azacytidine (see Azacitidine)
- Azaserine 10 (1976) (corr. 42); Suppl. 7 (1987)
- Azathioprine 26 (1981); Suppl. 7 (1987); 100A (2012)
- Aziridine 9 (1975); Suppl. 7 (1987); 71 (1999)
- 2-(1-Aziridinyl)ethanol..... 9 (1975); Suppl. 7 (1987)
- Aziridyl benzoquinone 9 (1975); Suppl. 7 (1987)
- Azobenzene 8 (1975); Suppl. 7 (1987)
- AZT (see Zidovudine)

B

Barium chromate (see Chromium and chromium compounds)	
Basic chromic sulfate (see Chromium and chromium compounds)	
BCNU (see Bischloroethyl nitrosourea)	
11 <i>H</i> -Benz[<i>bc</i>]aceanthrylene	92 (2010)
Benz[<i>j</i>]aceanthrylene	92 (2010)
Benz[<i>l</i>]aceanthrylene	92 (2010)
Benz[<i>a</i>]acridine	32 (1983); Suppl. 7 (1987)
Benz[<i>c</i>]acridine.....	3 (1973); 32 (1983); Suppl. 7 (1987)
Benzal chloride.....	29 (1982); Suppl. 7 (1987); 71 (1999)
(see also α -Chlorinated toluenes and benzoyl chloride)	
Benz[<i>a</i>]anthracene	3 (1973); 32 (1983); Suppl. 7 (1987); 92 (2010)
Benzene	7 (1974) (corr. 42); 29 (1982); Suppl. 7 (1987); 100F (2012)
Benzidine	1 (1972); 29 (1982); Suppl. 7 (1987); 100F (2012)
Benzidine-based dyes	Suppl. 7 (1987); 100F (2012)
Benzo[<i>b</i>]chrysene	92 (2010)
Benzo[<i>g</i>]chrysene	92 (2010)
Benzo[<i>a</i>]fluoranthene	92 (2010)
Benzo[<i>b</i>]fluoranthene	3 (1973); 32 (1983); Suppl. 7 (1987); 92 (2010)
Benzo[<i>j</i>]fluoranthene	3 (1973); 32 (1983); Suppl. 7 (1987); 92 (2010)
Benzo[<i>k</i>]fluoranthene	32 (1983); Suppl. 7 (1987); 92 (2010)
Benzo[<i>ghi</i>]fluoranthene	32 (1983); Suppl. 7 (1987); 92 (2010)
Benzo[<i>a</i>]fluorene.....	32 (1983); Suppl. 7 (1987); 92 (2010)
Benzo[<i>b</i>]fluorene.....	32 (1983); Suppl. 7 (1987); 92 (2010)
Benzo[<i>c</i>]fluorene	32 (1983); Suppl. 7 (1987); 92 (2010)
Benzofuran	63 (1995)
Benzo[<i>ghi</i>]perylene	32 (1983); Suppl. 7 (1987); 92 (2010)
Benzo[<i>c</i>]phenanthrene	32 (1983); Suppl. 7 (1987); 92 (2010)
Benzophenone.....	101 (2012)
Benzo[<i>a</i>]pyrene	3 (1973); 32 (1983); (corr. 68); Suppl. 7 (1987); 92 (2010); 100F (2012)
Benzo[<i>e</i>]pyrene	3 (1973); 32 (1983); Suppl. 7 (1987); 92 (2010)
1,4-Benzoquinone (see <i>para</i> -Quinone)	
1,4-Benzoquinone dioxime	29 (1982); Suppl. 7 (1987); 71 (1999)
Benzotrichloride	29 (1982); Suppl. 7 (1987); 71 (1999)
(see also α -Chlorinated toluenes and benzoyl chloride)	
Benzoyl chloride	29 (1982) (corr. 42); Suppl. 7 (1987); 71 (1999)
(see also α -Chlorinated toluenes and benzoyl chloride)	
Benzoyl peroxide.....	36 (1985); Suppl. 7 (1987); 71 (1999)
Benzyl acetate	40 (1986); Suppl. 7 (1987); 71 (1999)
Benzyl chloride.....	11 (1976) (corr. 42); 29 (1982); Suppl. 7 (1987); 71 (1999)
(see also α -Chlorinated toluenes and benzoyl chloride)	
Benzyl violet 4B	16 (1978); Suppl. 7 (1987)
Bertrandite (see Beryllium and beryllium compounds)	
Beryllium and beryllium compounds.....	1 (1972); 23 (1980) (corr. 42); Suppl. 7 (1987); 58 (1993); 100C (2012)

- Beryllium acetate (see Beryllium and beryllium compounds)
Beryllium acetate, basic (see Beryllium and beryllium compounds)
Beryllium-aluminium alloy (see Beryllium and beryllium compounds)
Beryllium carbonate (see Beryllium and beryllium compounds)
Beryllium chloride (see Beryllium and beryllium compounds)
Beryllium-copper alloy (see Beryllium and beryllium compounds)
Beryllium-copper-cobalt alloy (see Beryllium and beryllium compounds)
Beryllium fluoride (see Beryllium and beryllium compounds)
Beryllium hydroxide (see Beryllium and beryllium compounds)
Beryllium-nickel alloy (see Beryllium and beryllium compounds)
Beryllium oxide (see Beryllium and beryllium compounds)
Beryllium phosphate (see Beryllium and beryllium compounds)
Beryllium silicate (see Beryllium and beryllium compounds)
Beryllium sulfate (see Beryllium and beryllium compounds)
Beryl ore (see Beryllium and beryllium compounds)
Betel quid with added tobacco 37 (1985); Suppl. 7 (1987); 85 (2004); 100E (2012)
Betel quid without added tobacco 37 (1985); Suppl. 7 (1987); 85 (2004); 100E (2012)
BHA (see Butylated hydroxyanisole)
BHT (see Butylated hydroxytoluene)
Biomass fuel (primarily wood), indoor emissions from household combustion of 95 (2010)
Bis(1-aziridinyl)morpholinophosphine sulfide 9 (1975); Suppl. 7 (1987)
2,2-Bis(bromomethyl)propane-1,3-diol 77 (2000)
Bis(2-chloroethyl)ether 9 (1975); Suppl. 7 (1987); 71 (1999)
N,N-Bis(2-chloroethyl)-2-naphthylamine 4 (1974) (corr. 42); Suppl. 7 (1987); 100A (2012)
Bischloroethyl nitrosourea (see also Chloroethyl nitrosoureas) 26 (1981); Suppl. 7 (1987)
1,2-Bis(chloromethoxy)ethane 15 (1977); Suppl. 7 (1987); 71 (1999)
1,4-Bis(chloromethoxymethyl)benzene 15 (1977); Suppl. 7 (1987); 71 (1999)
Bis(chloromethyl)ether 4 (1974) (corr. 42); Suppl. 7 (1987); 100F (2012)
Bis(2-chloro-1-methylethyl)ether 41 (1986); Suppl. 7 (1987); 71 (1999)
Bis(2,3-epoxycyclopentyl)ether 47 (1989); 71 (1999)
Bisphenol A diglycidyl ether (see also Glycidyl ethers) 71 (1999)
Bisulfites (see Sulfur dioxide and some sulfites, bisulfites and metabisulfites)
Bitumens 35 (1985); Suppl. 7 (1987)
Bleomycins (see also Etoposide) 26 (1981); Suppl. 7 (1987)
Blue VRS 16 (1978); Suppl. 7 (1987)
Boot and shoe manufacture and repair 25 (1981); Suppl. 7 (1987)
Bracken fern 40 (1986); Suppl. 7 (1987)
Brilliant Blue FCF, disodium salt 16 (1978) (corr. 42); Suppl. 7 (1987)
Bromochloroacetic acid 101 (2012)
Bromochloroacetonitrile (see also Halogenated acetonitriles) 71 (1999)
Bromodichloromethane 52 (1991); 71 (1999)
Bromoethane 52 (1991); 71 (1999)
Bromoform 52 (1991); 71 (1999)
Busulfan (see 1,4-Butanediol dimethanesulfonate)
1,3-Butadiene 39 (1986) (corr. 42); Suppl. 7 (1987); 54 (1992); 71 (1999); 97 (2008); 100F (2012)
1,4-Butanediol dimethanesulfonate 4 (1974); Suppl. 7 (1987); 100A (2012)

2-Butoxyethanol	88 (2006)
1- <i>tert</i> -Butoxypropan-2-ol	88 (2006)
<i>n</i> -Butyl acrylate	39 (1986); Suppl. 7 (1987); 71 (1999)
Butylated hydroxyanisole	40 (1986); Suppl. 7 (1987)
Butylated hydroxytoluene	40 (1986); Suppl. 7 (1987)
Butyl benzyl phthalate	29 (1982) (corr. 42); Suppl. 7 (1987); 73 (1999)
β -Butyrolactone	11 (1976); Suppl. 7 (1987); 71 (1999)
γ -Butyrolactone	11 (1976); Suppl. 7 (1987); 71 (1999)

C

Cabinet-making (see Furniture and cabinet-making)	
Cadmium acetate (see Cadmium and cadmium compounds)	
Cadmium and cadmium compounds	2 (1973); 11 (1976) (corr. 42); Suppl. 7 (1987); 58 (1993); 100C (2012)
Cadmium chloride (see Cadmium and cadmium compounds)	
Cadmium oxide (see Cadmium and cadmium compounds)	
Cadmium sulfate (see Cadmium and cadmium compounds)	
Cadmium sulfide (see Cadmium and cadmium compounds)	
Caffeic acid	56 (1993)
Caffeine	51 (1991)
Calcium arsenate (see Arsenic in drinking-water)	
Calcium carbide production	92 (2010)
Calcium chromate (see Chromium and chromium compounds)	
Calcium cyclamate (see Cyclamates)	
Calcium saccharin (see Saccharin)	
Cantharidin	10 (1976); Suppl. 7 (1987)
Caprolactam	19 (1979) (corr. 42); 39 (1986) (corr. 42); Suppl. 7 (1987); 71 (1999)
Captafol	53 (1991)
Captan	30 (1983); Suppl. 7 (1987)
Carbaryl	12 (1976); Suppl. 7 (1987)
Carbazole	32 (1983); Suppl. 7 (1987); 71 (1999)
3-Carboxypsoralen	40, 317 (1986); Suppl. 7, 59 (1987)
Carbon black	3 (1973); 33 (1984); Suppl. 7 (1987); 65 (1996); 93, (2010)
Carbon electrode manufacture	92 (2010)
Carbon tetrachloride	1 (1972); 20 (1979); Suppl. 7 (1987); 71 (1999)
Carmoisine	8 (1975); Suppl. 7 (1987)
Carpentry and joinery	25 (1981); Suppl. 7 (1987)
Carrageenan	10 (1976) (corr. 42); 31 (1983); Suppl. 7 (1987)
Cassia occidentalis (see Traditional herbal medicines)	
Catechol	15 (1977); Suppl. 7 (1987); 71 (1999)
CCNU (see 1-(2-Chloroethyl)-3-cyclohexyl-1-nitrosourea)	
Ceramic fibres (see Man-made vitreous fibres)	
Chemotherapy, combined, including alkylating agents (see MOPP and other combined chemotherapy including alkylating agents)	

- Chimney sweeps and other exposures to soot 92 (2010); 100F (2012)
- Chloral (see also Chloral hydrate)63 (1995); 84 (2004)
- Chloral hydrate.....63 (1995); 84 (2004)
- Chlorambucil 9 (1975); 26 (1981); Suppl. 7 (1987); 100A (2012)
- Chloramine84 (2004)
- Chloramphenicol..... 10 (1976); Suppl. 7 (1987); 50 (1990)
- Chlordane (see also Chlordane and Heptachlor)20 (1979) (corr. 42)
- Chlordane and Heptachlor.....Suppl. 7 (1987); 53 (1991); 79 (2001)
- Chlordecone 20 (1979); Suppl. 7 (1987)
- Chlordimeform..... 30 (1983); Suppl. 7 (1987)
- Chlorendic acid48 (1990)
- Chlorinated dibenzodioxins (other than TCDD) 15 (1977); Suppl. 7 (1987)
(see also Polychlorinated dibenzo-para-dioxins)
- Chlorinated drinking-water52 (1991)
- Chlorinated paraffins48 (1990)
- α -Chlorinated toluenes and benzoyl chloride..... Suppl. 7 (1987); 71 (1999)
- Chlormadinone acetate 6 (1974); 21 (1979); Suppl. 7 (1987); 72 (1999)
- Chlornaphazine (see *N,N*-Bis(2-chloroethyl)-2-naphthylamine)
- Chloroacetonitrile (see also Halogenated acetonitriles)71 (1999)
- para*-Chloroaniline57 (1993)
- Chlorobenzilate 5 (1974); 30 (1983); Suppl. 7 (1987)
- Chlorodibromomethane.....52 (1991); 71 (1999)
- 3-Chloro-4-(dichloromethyl)-5-hydroxy-2(5*H*)-furanone84 (2004)
- Chlorodifluoromethane41 (1986) (corr. 51); Suppl. 7 (1987); 71 (1999)
- Chloroethane52 (1991); 71 (1999)
- 1-(2-Chloroethyl)-3-cyclohexyl-1-nitrosourea.....26 (1981) (corr. 42); Suppl. 7 (1987)
(see also Chloroethyl nitrosoureas)
- 1-(2-Chloroethyl)-3-(4-methylcyclohexyl)-1-nitrosourea Suppl. 7 (1987); 100A (2012)
(see also Chloroethyl nitrosoureas)
- Chloroethyl nitrosoureas Suppl. 7 (1987)
- Chlorofluoromethane41 (1986); Suppl. 7 (1987); 71 (1999)
- Chloroform 1 (1972); 20 (1979); Suppl. 7 (1987); 73(1999)
- Chloromethyl methyl ether (technical-grade).....4 (1974); Suppl. 7 (1987); 100F (2012)
(see also Bis(chloromethyl)ether)
- (4-Chloro-2-methylphenoxy)acetic acid (see MCPA)
- 1-Chloro-2-methylpropene63 (1995)
- 3-Chloro-2-methylpropene63 (1995)
- 2-Chloronitrobenzene.....65 (1996)
- 3-Chloronitrobenzene.....65 (1996)
- 4-Chloronitrobenzene.....65 (1996)
- Chlorophenols (see also Polychlorophenols and their sodium salts) Suppl. 7 (1987)
- Chlorophenols (occupational exposures to)41 (1986)
- Chlorophenoxy herbicides..... Suppl. 7 (1987)
- Chlorophenoxy herbicides (occupational exposures to).....41 (1986)
- 4-Chloro-*ortho*-phenylenediamine..... 27 (1982); Suppl. 7 (1987)
- 4-Chloro-*meta*-phenylenediamine 27 (1982); Suppl. 7 (1987)

Chloroprene	19 (1979); Suppl. 7 (1987); 71 (1999)	
Chloropropham	12 (1976); Suppl. 7 (1987)	
Chloroquine	13 (1977); Suppl. 7 (1987)	
Chlorothalonil.....	30 (1983); Suppl. 7 (1987); 73 (1999)	
<i>para</i> -Chloro- <i>ortho</i> -toluidine and its strong acid salts.....	16 (1978); 30 (1983); Suppl. 7 (1987); (see also Chlordimeform)	48 (1990); 77 (2000)
4-Chloro- <i>ortho</i> -toluidine (see <i>para</i> -chloro- <i>ortho</i> -toluidine)		
5-Chloro- <i>ortho</i> -toluidine	77 (2000)	
Chlorotrianisene (see also Nonsteroidal estrogens)	21 (1979); Suppl. 7 (1987)	
2-Chloro-1,1,1-trifluoroethane	41 (1986); Suppl. 7 (1987); 71 (1999)	
Chlorozotocin.....	50 (1990)	
Cholesterol.....	10 (1976); 31 (1983); Suppl. 7 (1987)	
Chromic acetate (see Chromium and chromium compounds)		
Chromic chloride (see Chromium and chromium compounds)		
Chromic oxide (see Chromium and chromium compounds)		
Chromic phosphate (see Chromium and chromium compounds)		
Chromite ore (see Chromium and chromium compounds)		
Chromium and chromium compounds.....	2 (1973); 23 (1980); Suppl. 7 (1987); 49 (1990) (corr. 51); (see also Implants, surgical)	100C (2012)
Chromium carbonyl (see Chromium and chromium compounds)		
Chromium potassium sulfate (see Chromium and chromium compounds)		
Chromium sulfate (see Chromium and chromium compounds)		
Chromium trioxide (see Chromium and chromium compounds)		
Chrysazin (see Dantron)		
Chrysene.....	3 (1973); 32 (1983); Suppl. 7 (1987); 92 (2010)	
Chrysoidine	8 (1975); Suppl. 7 (1987)	
Chrysotile (see Asbestos)		
Ciclosporin.....	50 (1990); 100A (2012)	
CI Acid Orange 3	57 (1993)	
CI Acid Red 114	57 (1993)	
CI Basic Red 9 (see also Magenta)	57 (1993)	
CI Direct Blue 15.....	57 (1993)	
CI Disperse Yellow 3 (see Disperse Yellow 3)		
Cimetidine.....	50 (1990)	
Cinnamyl anthranilate	16 (1978); 31 (1983); Suppl. 7 (1987); 77 (2000)	
CI Pigment Red 3	57 (1993)	
CI Pigment Red 53:1 (see D&C Red No. 9)		
Cisplatin (see also Etoposide)	26 (1981); Suppl. 7 (1987)	
Citrinin.....	40 (1986); Suppl. 7 (1987)	
Citrus Red No. 2	8 (1975) (corr. 42); Suppl. 7 (1987)	
Clinoptilolite (see Zeolites)		
Clofibrate	24 (1980); Suppl. 7 (1987); 66 (1996)	
Clomiphene citrate.....	21 (1979); Suppl. 7 (1987)	
Clonorchis sinensis, infection with	61 (1994); 100B (2012)	
Coal, indoor emissions from household combustion of	95 (2010); 100E (2012)	
Coal dust.....	68 (1997)	

- Coal gasification..... 34 (1984); Suppl. 7 (1987); 92 (2010); 100F (2012)
- Coal-tar distillation 92 (2010); 100F (2012)
- Coal-tar pitches (see also Coal-tars) 35 (1985); Suppl. 7 (1987); 100F (2012)
- Coal-tars 35 (1985); Suppl. 7 (1987); 100F (2012)
- Cobalt[III] acetate (see Cobalt and cobalt compounds)
- Cobalt-aluminium-chromium spinel (see Cobalt and cobalt compounds)
- Cobalt and cobalt compounds (see also Implants, surgical) 52 (1991)
- Cobalt[II] chloride (see Cobalt and cobalt compounds)
- Cobalt-chromium alloy (see Chromium and chromium compounds)
- Cobalt-chromium-molybdenum alloys (see Cobalt and cobalt compounds)
- Cobalt metal powder (see Cobalt and cobalt compounds)
- Cobalt metal with tungsten carbide..... 86 (2006)
- Cobalt metal without tungsten carbide 86 (2006)
- Cobalt naphthenate (see Cobalt and cobalt compounds)
- Cobalt[II] oxide (see Cobalt and cobalt compounds)
- Cobalt[II,III] oxide (see Cobalt and cobalt compounds)
- Cobalt sulfate and other soluble cobalt(II) salts 86 (2006)
- Cobalt[II] sulfide (see Cobalt and cobalt compounds)
- Coconut oil diethanolamine condensate 101 (2012)
- Coffee 51 (1991) (corr. 52)
- Coke production 34 (1984); Suppl. 7 (1987); 92 (2010); 100F (2012)
- Combined estrogen–progestogen contraceptives ... Suppl. 7 (1987); 72 (1999); 91 (2007); 100A (2012)
- Combined estrogen–progestogen menopausal therapy Suppl. 7 (1987); 72 (1999); 91 (2007);
100A (2012)
- Conjugated equine estrogens 72 (1999)
- Conjugated estrogens (see also Steroidal estrogens)..... 21 (1979); Suppl. 7 (1987)
- Continuous glass filament (see Man-made vitreous fibres)
- Copper 8-hydroxyquinoline 15 (1977); Suppl. 7 (1987)
- Coronene 32 (1983); Suppl. 7 (1987); 92 (2010)
- Coumarin 10 (1976); Suppl. 7 (1987); 77 (2000)
- Creosotes (see also Coal-tars) 35 (1985); Suppl. 7 (1987); 92 (2010)
- meta*-Cresidine..... 27 (1982); Suppl. 7 (1987)
- para*-Cresidine 27 (1982); Suppl. 7 (1987)
- Cristobalite (see Crystalline silica)
- Crocidolite (see Asbestos)
- Crotonaldehyde..... 63 (1995) (corr. 65)
- Crude oil 45 (1989)
- Crystalline silica (see also Silica)..... 42 (1987); Suppl. 7 (1987); 68 (1997) (corr. 81); 100C (2012)
- Cumene 101 (2012)
- Cycasin (see also Methylazoxymethanol)..... 1 (1972) (corr. 42); 10 (1976); Suppl. 7 (1987)
- Cyclamates..... 22 (1980); Suppl. 7 (1987); 73 (1999)
- Cyclamic acid (see Cyclamates)
- Cyclochlorotine 10 (1976); Suppl. 7 (1987)
- Cyclohexanone..... 47 (1989); 71 (1999)
- Cyclohexylamine (see Cyclamates)
- 4-Cyclopenta[*def*]chrysene 92 (2010)

Cyclopenta[<i>cd</i>]pyrene	32 (1983); Suppl. 7 (1987); 92 (2010)
5,6-Cyclopenteno-1,2-benzanthracene	92 (2010)
Cyclopropane (see Anaesthetics, volatile)	
Cyclophosphamide	9 (1975); 26 (1981); Suppl. 7 (1987); 100A (2012)
Cyproterone acetate	72 (1999)

D

2,4-D	15 (1977)
(see also Chlorophenoxy herbicides; Chlorophenoxy herbicides, occupational exposures to)	
Dacarbazine	26 (1981); Suppl. 7 (1987)
Dantron	50 (1990) (corr. 59)
D&C Red No. 9	8 (1975); Suppl. 7 (1987); 57 (1993)
Dapsone	24 (1980); Suppl. 7 (1987)
Daunomycin	10 (1976); Suppl. 7 (1987)
DDD (see DDT)	
DDE (see DDT)	
DDT	5 (1974) (corr. 42); Suppl. 7 (1987); 53 (1991)
Decabromodiphenyl oxide	48 (1990); 71 (1999)
Deltamethrin	53 (1991)
Deoxynivalenol (see Toxins derived from <i>Fusarium graminearum</i> , <i>F. culmorum</i> and <i>F. crookwellense</i>)	
Diacetylaminoazotoluene	8 (1975); Suppl. 7 (1987)
<i>N,N'</i> -Diacetylbenzidine	16 (1978); Suppl. 7 (1987)
Diallate	12 (1976); 30 (1983); Suppl. 7 (1987)
2,4-Diaminoanisole and its salts	16 (1978); 27 (1982); Suppl. 7 (1987); 79 (2001)
4,4'-Diaminodiphenyl ether	16 (1978); 29 (1982); Suppl. 7 (1987)
1,2-Diamino-4-nitrobenzene	16 (1978); Suppl. 7 (1987)
1,4-Diamino-2-nitrobenzene	16 (1978); Suppl. 7 (1987); 57 (1993)
2,6-Diamino-3-(phenylazo)pyridine (see Phenazopyridine hydrochloride)	
2,4-Diaminotoluene (see also Toluene diisocyanates)	16 (1978); Suppl. 7 (1987)
2,5-Diaminotoluene (see also Toluene diisocyanates)	16 (1978); Suppl. 7 (1987)
<i>ortho</i> -Dianisidine (see 3,3'-Dimethoxybenzidine)	
Diatomaceous earth, uncalcined (see Amorphous silica)	
Diazepam	13 (1977); Suppl. 7 (1987); 66 (1996)
Diazomethane	7 (1974); Suppl. 7 (1987)
Dibenz[<i>a,h</i>]acridine	3 (1973); 32 (1983); Suppl. 7 (1987)
Dibenz[<i>a,j</i>]acridine	3 (1973); 32 (1983); Suppl. 7 (1987)
Dibenz[<i>a,c</i>]anthracene	32 (1983) (corr. 42); Suppl. 7 (1987); 92 (2010)
Dibenz[<i>a,h</i>]anthracene	3 (1973) (corr. 43); 32 (1983); Suppl. 7 (1987); 92 (2010)
Dibenz[<i>a,j</i>]anthracene	32 (1983); Suppl. 7 (1987); 92 (2010)
7 <i>H</i> -Dibenzo[<i>c,g</i>]carbazole	3 (1973); 32 (1983); Suppl. 7 (1987)
Dibenzodioxins, chlorinated, other than TCDD (see Chlorinated dibenzodioxins, other than TCDD)	
Dibenzo[<i>a,e</i>]fluoranthene	32 (1983); Suppl. 7 (1987); 92 (2010)
13 <i>H</i> -Dibenzo[<i>a,g</i>]fluorene	92 (2010)
Dibenzo[<i>h,rst</i>]pentaphene	3 (1973); Suppl. 7 (1987); 92 (2010)

- Dibenzo[*a,e*]pyrene 3 (1973); 32 (1983); Suppl. 7 (1987); 92 (2010)
- Dibenzo[*a,h*]pyrene 3 (1973); 32 (1983); Suppl. 7 (1987); 92 (2010)
- Dibenzo[*a,i*]pyrene 3 (1973); 32 (1983); Suppl. 7 (1987); 92 (2010)
- Dibenzo[*a,l*]pyrene 3 (1973); 32 (1983); Suppl. 7 (1987); 92 (2010)
- Dibenzo[*e,l*]pyrene 92 (2010)
- Dibenzo-*para*-dioxin 69 (1997)
- Dibromoacetic acid 101 (2012)
- Dibromoacetonitrile (see also Halogenated acetonitriles) 71 (1999); 101 (2012)
- 1,2-Dibromo-3-chloropropane 15 (1977); 20 (1979); Suppl. 7 (1987); 71 (1999)
- 1,2-Dibromoethane (see Ethylene dibromide)
- 2,3-Dibromopropan-1-ol 77 (2000)
- Dichloroacetic acid 63 (1995); 84 (2004)
- Dichloroacetonitrile (see also Halogenated acetonitriles) 71 (1999)
- Dichloroacetylene 39 (1986); Suppl. 7 (1987); 71 (1999)
- ortho*-Dichlorobenzene 7 (1974); 29 (1982); Suppl. 7 (1987); 73 (1999)
- meta*-Dichlorobenzene 73 (1999)
- para*-Dichlorobenzene 7 (1974); 29 (1982); Suppl. 7 (1987); 73 (1999)
- 3,3'-Dichlorobenzidine 4 (1974); 29 (1982); Suppl. 7 (1987)
- trans*-1,4-Dichlorobutene 15 (1977); Suppl. 7 (1987); 71 (1999)
- 3,3'-Dichloro-4,4'-diaminodiphenyl ether 16 (1978); Suppl. 7 (1987)
- 1,2-Dichloroethane 20 (1979); Suppl. 7 (1987); 71 (1999)
- Dichloromethane 20 (1979); 41 (1986); Suppl. 7 (1987); 71 (1999)
- 2,4-Dichlorophenol (see Chlorophenols; Chlorophenols, occupational exposures to; Polychlorophenols and their sodium salts)
- (2,4-Dichlorophenoxy)acetic acid (see 2,4-D)
- 2,6-Dichloro-*para*-phenylenediamine 39 (1986); Suppl. 7 (1987)
- 1,2-Dichloropropane 41 (1986); Suppl. 7 (1987); 71 (1999)
- 1,3-Dichloro-2-propanol 101 (2012)
- 1,3-Dichloropropene, technical-grade 41 (1986); Suppl. 7 (1987); 71 (1999)
- Dichlorvos 20 (1979); Suppl. 7 (1987); 53 (1991)
- Dicofol 30 (1983); Suppl. 7 (1987)
- Dicyclohexylamine (see Cyclamates)
- Didanosine 76 (2000)
- Dieldrin 5 (1974); Suppl. 7 (1987)
- Dienoestrol (see also Nonsteroidal estrogens) 21 (1979); Suppl. 7 (1987)
- Diepoxybutane (see also 1,3-Butadiene) 11 (1976) (corr. 42); Suppl. 7 (1987); 71 (1999)
- Diesel and gasoline engine exhausts 46 (1989)
- Diesel fuels 45 (1989) (corr. 47)
- Diethanolamine 77 (2000); 101 (2012)
- Diethyl ether (see Anaesthetics, volatile)
- Di(2-ethylhexyl) adipate 29 (1982); Suppl. 7 (1987); 77 (2000)
- Di(2-ethylhexyl) phthalate 29 (1982) (corr. 42); Suppl. 7 (1987); 77 (2000); 101 (2012)
- 1,2-Diethylhydrazine 4 (1974); Suppl. 7 (1987); 71 (1999)
- Diethylstilbestrol 6 (1974); 21 (1979) (corr. 42); Suppl. 7 (1987); 100A (2012)
- Diethylstilbestrol dipropionate (see Diethylstilbestrol)
- Diethyl sulfate 4 (1974); Suppl. 7 (1987); 54 (1992); 71 (1999)

<i>N,N'</i> -Diethylthiourea	79 (2001)
Diglycidyl resorcinol ether	11 (1976); 36 (1985); Suppl. 7 (1987); 71 (1999)
Dihydrosafrole	1 (1972); 10 (1976) Suppl. 7 (1987)
1,2-Dihydroaceanthrylene	92 (2010)
1,8-Dihydroxyanthraquinone (see Dantron)	
Dihydroxybenzenes (see Catechol; Hydroquinone; Resorcinol)	
1,3-Dihydroxy-2-hydroxymethylanthraquinone	82 (2002)
Dihydroxymethylfuratrizine	24 (1980); Suppl. 7 (1987)
Diisopropyl sulfate	54 (1992); 71 (1999)
Dimethisterone (see also Progestins; Sequential oral contraceptives)	6 (1974); 21 (1979)
Dimethoxane	15 (1977); Suppl. 7 (1987)
3,3'-Dimethoxybenzidine	4 (1974); Suppl. 7 (1987)
3,3'-Dimethoxybenzidine-4,4'-diisocyanate	39 (1986); Suppl. 7 (1987)
<i>para</i> -Dimethylaminoazobenzene	8 (1975); Suppl. 7 (1987)
<i>para</i> -Dimethylaminoazobenzenediazo sodium sulfonate	8 (1975); Suppl. 7 (1987)
<i>trans</i> -2-[(Dimethylamino)methylimino]-5-[2-(5-nitro-2-furyl)-vinyl]-1,3,4-oxadiazole (corr. 42); Suppl. 7 (1987)	7 (1974)
4,4'-Dimethylangelicin plus ultraviolet radiation (see also Angelicin and some synthetic derivatives)	Suppl. 7 (1987)
4,5'-Dimethylangelicin plus ultraviolet radiation (see also Angelicin and some synthetic derivatives)	Suppl. 7 (1987)
2,6-Dimethylaniline	57 (1993)
<i>N,N</i> -Dimethylaniline	57 (1993)
Dimethylarsinic acid (see Arsenic and arsenic compounds)	
3,3'-Dimethylbenzidine	1 (1972); Suppl. 7 (1987); 100F (2012)
Dimethylcarbamoyl chloride	12 (1976); Suppl. 7 (1987); 71 (1999)
Dimethylformamide	47 (1989); 71 (1999)
1,1-Dimethylhydrazine	4 (1974); Suppl. 7 (1987); 71 (1999)
1,2-Dimethylhydrazine	4 (1974) (corr. 42); Suppl. 7 (1987); 71 (1999)
Dimethyl hydrogen phosphite	48 (1990); 71 (1999)
1,4-Dimethylphenanthrene	32 (1983); Suppl. 7 (1987); 92 (2010)
Dimethyl sulfate	41 (1974); Suppl. 7 (1987); 71 (1999)
3,7-Dinitrofluoranthene	46 (1989); 65 (1996)
3,9-Dinitrofluoranthene	46 (1989); 65 (1996)
1,3-Dinitropyrene	46 (1989)
1,6-Dinitropyrene	46 (1989)
1,8-Dinitropyrene	33 (1984); Suppl. 7 (1987); 46 (1989)
Dinitrosopentamethylenetetramine	11 (1976); Suppl. 7 (1987)
2,4-Dinitrotoluene	65 (1996) (corr. 66)
2,6-Dinitrotoluene	65 (1996) (corr. 66)
3,5-Dinitrotoluene	65 (1996)
1,4-Dioxane	11 (1976); Suppl. 7 (1987); 71 (1999)
2,4'-Diphenyldiamine	16 (1978); Suppl. 7 (1987)
Direct Black 38 (see also Benzidine-based dyes)	29 (1982) (corr. 42)
Direct Blue 6 (see also Benzidine-based dyes)	29 (1982)
Direct Brown 95 (see also Benzidine-based dyes)	29 (1982)

Disperse Blue 1	48 (1990)
Disperse Yellow 3	8 (1975); Suppl. 7 (1987); 48 (1990)
Disulfiram	12 (1976); Suppl. 7 (1987)
Dithranol	13 (1977); Suppl. 7 (1987)
Divinyl ether (see Anaesthetics, volatile)	
Doxefazepam	66 (1996)
Doxylamine succinate	79 (2001)
Droloxifene	66 (1996)
Dry cleaning	63 (1995)
Dulcin	12 (1976); Suppl. 7 (1987)

E

Endrin	5 (1974); Suppl. 7 (1987)
Enflurane (see Anaesthetics, volatile)	
Eosin	15 (1977); Suppl. 7 (1987)
Epichlorohydrin	11 (1976) (corr. 42); Suppl. 7 (1987); 71 (1999)
1,2-Epoxybutane	47 (1989); 71 (1999)
1-Epoxyethyl-3,4-epoxycyclohexane (see 4-Vinylcyclohexene diepoxide)	
3,4-Epoxy-6-methylcyclohexylmethyl-3,4-epoxy-6-methyl-cyclohexane carboxylate	11 (1976); Suppl. 7 (1987); 71 (1999)
<i>cis</i> -9,10-Epoxystearic acid	11 (1976); Suppl. 7 (1987); 71 (1999)
Epstein-Barr virus	70 (1997); 100B (2012)
<i>d</i> -Equilenin	72 (1999)
Equilin	72 (1999)
Erionite	42 (1987); Suppl. 7 (1987); 100C (2012)
Estazolam	66 (1996)
Estradiol	6 (1974); 21 (1979); Suppl. 7 (1987); 72 (1999)
Estradiol-17 β (see Estradiol)	
Estradiol 3-benzoate (see Estradiol)	
Estradiol dipropionate (see Estradiol)	
Estradiol mustard	9 (1975); Suppl. 7 (1987)
Estradiol valerate (see Estradiol)	
Estriol	6 (1974); 21 (1979); Suppl. 7 (1987); 72 (1999)
Estrogen replacement therapy (see Post-menopausal estrogen therapy)	
Estrogens (see Estrogens, progestins and combinations)	
Estrogens, conjugated (see Conjugated estrogens)	
Estrogens, nonsteroidal (see Nonsteroidal estrogens)	
Estrogens, progestins (progestogens) and combinations	6 (1974); 21 (1979); Suppl. 7 (1987); 72 (1999)
Estrogens, steroidal (see Steroidal estrogens)	
Estrone	6 (1974); 21 (1979) (corr. 42); Suppl. 7 (1987); 72 (1999)
Estrone benzoate (see Estrone)	
Ethanol in alcoholic beverages	41 (2010); 100E (2012)
Ethinylloestradiol	6 (1974); 21 (1979); Suppl. 7 (1987); 72 (1999)

Ethionamide	13 (1977); Suppl. 7 (1987)
Ethyl acrylate.....	19 (1979); 39 (1986); Suppl. 7 (1987); 71 (1999)
Ethyl carbamate.....	7 (1974); Suppl. 7 (1987); 96 (2010)
Ethylbenzene	77 (2000)
Ethylene	19 (1979); Suppl. 7 (1987); 60 (1994); 71 (1999)
Ethylene dibromide	15 (1977); Suppl. 7 (1987); 71 (1999)
Ethylene oxide	11 (1976); 36 (1985) (corr. 42); Suppl. 7 (1987); 60 (1994); 97 (2008); 100F (2012)
Ethylene sulfide	11, 257 (1976); Suppl. 7, 63 (1987)
Ethylenethiourea	7 (1974); Suppl. 7 (1987); 79 (2001)
2-Ethylhexyl acrylate	60 (1994)
Ethyl methanesulfonate	7 (1974); Suppl. 7 (1987)
<i>N</i> -Ethyl- <i>N</i> -nitrosourea	1 (1972); 17 (1978); Suppl. 7 (1987)
Ethyl selenac (see also Selenium and selenium compounds)	12 (1976); Suppl. 7 (1987)
Ethyl tellurac	12 (1976); Suppl. 7 (1987)
Ethynodiol diacetate	6 (1974); 21 (1979); Suppl. 7 (1987); 72 (1999)
Etoposide.....	76 (2000); 100A (2012)
Eugenol.....	36 (1985); Suppl. 7 (1987)
Evans blue	8 (1975); Suppl. 7 (1987)
Extremely low-frequency electric fields	80 (2002)
Extremely low-frequency magnetic fields	80 (2002)

F

Fast Green FCF	16 (1978); Suppl. 7 (1987)
Fenvalerate	53 (1991)
Ferbam	12 (1976) (corr. 42); Suppl. 7 (1987)
Ferric oxide	1 (1972); Suppl. 7 (1987)
Ferrocromium (see Chromium and chromium compounds)	
Firefighting	98 (2010)
Fission products, mixtures of	100D (2012)
Fluometuron.....	30 (1983); Suppl. 7 (1987)
Fluoranthene	32 (1983); Suppl. 7 (1987); 92 (2010)
Fluorene	32 (1983); Suppl. 7 (1987); 92 (2010)
Fluorescent lighting, exposure to (see Ultraviolet radiation)	
Fluorides, inorganic, used in drinking-water	27 (1982); Suppl. 7 (1987)
5-Fluorouracil	26 (1981); Suppl. 7 (1987)
Fluorspar (see Fluorides)	
Fluosilicic acid (see Fluorides)	
Fluroxene (see Anaesthetics, volatile)	
Foreign bodies	74 (1999)
Formaldehyde	29 (1982); Suppl. 7 (1987); 62 (1995) (corr. 65; corr. 66); 88 (2006); 100F (2012)
2-(2-Formylhydrazino)-4-(5-nitro-2-furyl)thiazole	7 (1974) (corr. 42); Suppl. 7 (1987)
Frusemide (see Furosemide)	
Frying, emissions from high-temperature	95 (2010)
Fuel oils (heating oils)	45 (1989) (corr. 47)

Fumonisin B1 (see also Toxins derived from <i>Fusarium moniliforme</i>)	82 (2002)
Fumonisin B2 (see Toxins derived from <i>Fusarium moniliforme</i>)	
Furan	63 (1995)
Furazolidone	31 (1983); Suppl. 7 (1987)
Furfural	63 (1995)
Furniture and cabinet-making	25 (1981)
Furosemide	50 (1990)
2-(2-Furyl)-3-(5-nitro-2-furyl)acrylamide (see AF-2)	
Fusarenon-X (see Toxins derived from <i>Fusarium graminearum</i> , <i>F. culmorum</i> and <i>F. crookwellense</i>)	
Fusarenone-X (see Toxins derived from <i>Fusarium graminearum</i> , <i>F. culmorum</i> and <i>F. crookwellense</i>)	
Fusarin C (see Toxins derived from <i>Fusarium moniliforme</i>)	

G

Gallium arsenide	86 (2006)
Gamma (γ)-radiation	75 (2000); 100D (2012)
Gasoline	45 (1989) (corr. 47)
Gasoline engine exhaust (see Diesel and gasoline engine exhausts)	
Gemfibrozil	66 (1996)
Glass fibres (see Man-made mineral fibres)	
Glass manufacturing industry, occupational exposures in	58 (1993)
Glass wool (see Man-made vitreous fibres)	
Glass filaments (see Man-made mineral fibres)	
Glu-P-1	403 (1986); Suppl. 7 (1987)
Glu-P-2	40 (1986); Suppl. 7 (1987)
L-Glutamic acid, 5-[2-(4-hydroxymethyl)phenylhydrazide] (see Agaritine)	
Glycidaldehyde	11 (1976); Suppl. 7 (1987); 71 (1999)
Glycidol	77 (2000)
Glycidyl ethers	47 (1989); 71 (1999)
Glycidyl oleate	11 (1976); Suppl. 7 (1987)
Glycidyl stearate	11 (1976); Suppl. 7 (1987)
Griseofulvin	10 (1976); Suppl. 7 (1987); 79 (2001)
Guinea Green B	16 (1978); Suppl. 7 (1987)
Gyromitrin	31 (1983); Suppl. 7 (1987)

H

Haematite	1 (1972); Suppl. 7 (1987)
Haematite and ferric oxide	Suppl. 7 (1987)
Haematite mining, underground, with exposure to radon	1 (1972); Suppl. 7 (1987); 100D (2012)
Hairdressers and barbers, occupational exposure as	57 (1993)
Hair dyes, epidemiology of	16 (1978); 27 (1982)

Halogenated acetonitriles	52 (1991); 71 (1999)
Halothane (see Anaesthetics, volatile)	
HC Blue No. 1	57 (1993)
HC Blue No. 2	57 (1993)
α -HCH (see Hexachlorocyclohexanes)	
β -HCH (see Hexachlorocyclohexanes)	
γ -HCH (see Hexachlorocyclohexanes)	
HC Red No. 3	57 (1993)
HC Yellow No. 4	57 (1993)
Heating oils (see Fuel oils)	
<i>Helicobacter pylori</i> , infection with	61 (1994); 100B (2012)
Hepatitis B virus	59(1994); 100B (2012)
Hepatitis C virus	59 (1994); 100B5 (2012)
Hepatitis D virus	59 (1994)
Heptachlor (see also Chlordane and Heptachlor)	5 (1974); 20 (1979)
Hexachlorobenzene	20 (1979); Suppl. 7 (1987); 79 (2001)
Hexachlorobutadiene	20 (1979); Suppl. 7 (1987); 73 (1999)
Hexachlorocyclohexanes	5 (1974); 20 (1979) (corr. 42); Suppl. 7 (1987)
Hexachlorocyclohexane, technical-grade (see Hexachlorocyclohexanes)	
Hexachloroethane	20 (1979); Suppl. 7 (1987); 73 (1999)
Hexachlorophene	20 (1979); Suppl. 7 (1987)
Hexamethylphosphoramide	15 (1977); Suppl. 7 (1987); 71 (1999)
2,4-Hexadienal	101 (2012)
Hexestrol (see also Nonsteroidal estrogens)	Suppl. 7 (1987)
Hormonal contraceptives, progestogens only	72 (1999)
Human herpesvirus 8	70 (1997)
Human immunodeficiency viruses	67 (1996); 100B (2012)
Human papillomaviruses	64 (1995) (corr. 66); 90 (2007); 100B (2012)
Human T-cell lymphotropic viruses	67 (1996); 100B (2012)
Hycanthone mesylate	13 (1977); Suppl. 7 (1987)
Hydralazine	24 (1980); Suppl. 7, (1987)
Hydrazine	4 (1974); Suppl. 7 (1987); 71 (1999)
Hydrochloric acid	54 (1992)
Hydrochlorothiazide	50 (1990)
Hydrogen peroxide	36 (1985); Suppl. 7 (1987); 71 (1999)
Hydroquinone	15 (1977); Suppl. 7 (1987); 71 (1999)
1-Hydroxyanthraquinone	82 (2002)
4-Hydroxyazobenzene	8 (1975); Suppl. 7 (1987)
17 α -Hydroxyprogesterone caproate (see also Progestins)	21 (1979) (corr. 42)
8-Hydroxyquinoline	13 (1977); Suppl. 7 (1987)
8-Hydroxysenkirkine	10 (1976); Suppl. 7 (1987)
Hydroxyurea	76 (2000)
Hypochlorite salts	52 (1991)

I

- Implants, surgical 74 (1999)
- Indeno[1,2,3-*cd*]pyrene 3 (1973); 32 (1983); Suppl. 7 (1987); 92 (2010)
- Indium phosphide 86 (2006)
- Inorganic acids (see Sulfuric acid and other strong inorganic acids, occupational exposures to mists and vapours from)
- Inorganic lead compounds Suppl. 7 (1987); 87 (2006)
- Insecticides, occupational exposures in spraying and application of 53 (1991)
- Insulation glass wool (see Man-made vitreous fibres)
- Involuntary smoking (see Tobacco, Second-hand smoke)
- Ionizing radiation (all types) 100D (2012)
- IQ 40 (1986); Suppl. 7 (1987); 56 (1993)
- Iron and steel founding 34 (1984); Suppl. 7 (1987); 100F (2012)
- Iron-dextran complex 2 (1973); Suppl. 7 (1987)
- Iron-dextrin complex 2 (1973) (corr. 42); Suppl. 7 (1987)
- Iron oxide (see Ferric oxide)
- Iron oxide, saccharated (see Saccharated iron oxide)
- Iron sorbitol-citric acid complex 2 (1973); Suppl. 7 (1987)
- Isatidine 10 (1976); Suppl. 7 (1987)
- Isoflurane (see Anaesthetics, volatile)
- Isoniazid (see Isonicotinic acid hydrazide)
- Isonicotinic acid hydrazide 4 (1974); Suppl. 7 (1987)
- Isophosphamide 26 (1981); Suppl. 7 (1987)
- Isoprene 60 (1994); 71 (1999)
- Isopropanol 15 (1977); Suppl. 7 (1987); 71 (1999)
- Isopropanol manufacture (strong-acid process) Suppl. 7 (1987); 100F (2012)
(see also Isopropanol; Sulfuric acid and other strong inorganic acids, occupational exposures to mists and vapours from)
- Isopropyl oils 15 (1977); Suppl. 7 (1987); 71 (1999)
- Isosafrole 1 (1972); 10 (1976); Suppl. 7 (1987)

J

- Jacobine 10 (1976); Suppl. 7 (1987)
- Jet fuel 45 (1989)
- Joinery (see Carpentry and joinery)

K

- Kaempferol 31 (1983); Suppl. 7 (1987)
- Kaposi sarcoma herpesvirus 70 (1997); 100B (2012)
- Kepone (see Chlordecone)
- Kojic acid 79 (2001)

L

- Lasiocarpine 10 (1976); Suppl. 7 (1987)
- Lauroyl peroxide36 (1985); Suppl. 7 (1987); 71 (1999)
- Lead acetate (see Lead and lead compounds)
- Lead and lead compounds (see also Foreign bodies). 1 (1972) (corr. 421); 2 (1973); 12 (1976);
23 (1980); Suppl. 7 (1987); 87 (2006)
- Lead arsenate (see Arsenic and arsenic compounds)
- Lead carbonate (see Lead and lead compounds)
- Lead chloride (see Lead and lead compounds)
- Lead chromate (see Chromium and chromium compounds)
- Lead chromate oxide (see Chromium and chromium compounds)
- Lead compounds, inorganic and organic Suppl. 7 (1987); 87 (2006)
- Lead naphthenate (see Lead and lead compounds)
- Lead nitrate (see Lead and lead compounds)
- Lead oxide (see Lead and lead compounds)
- Lead phosphate (see Lead and lead compounds)
- Lead subacetate (see Lead and lead compounds)
- Lead tetroxide (see Lead and lead compounds)
- Leather goods manufacture 25 (1981); Suppl. 7 (1987); 100C (2012)
- Leather industries 25 (1981); Suppl. 7 (1987); 100C (2012)
- Leather tanning and processing 25 (1981); Suppl. 7 (1987); 100C (2012)
- Ledate (see also Lead and lead compounds).....12 (1976)
- Levonorgestrel72 (1999)
- Light Green SF 16 (1978); Suppl. 7 (1987)
- d*-Limonene56 (1993); 73 (1999)
- Lindane (see Hexachlorocyclohexanes)
- Liver flukes (see *Clonorchis sinensis*; *Opisthorchis felineus*; and *Opisthorchis viverrini*)
- Lucidin (see 1,3-Dihydro-2-hydroxymethylanthraquinone)
- Lumber and sawmill industries (including logging) 25 (1981); Suppl. 7 (1987)
- Luteoskyrin 10 (1976); Suppl. 7 (1987)
- Lynoestrenol21 (1979); Suppl. 7 (1987); 72 (1999)

M

- Madder root (see also *Rubia tinctorum*).....82 (2002)
- Magenta 4 (1974) (corr. 42); Suppl. 7 (1987); 57 (1993); 100F (2012)
- Magenta, manufacture of (see also Magenta)..... Suppl. 7 (1987); 57 (1993); 100F (2012)
- Malathion..... 30 (1983); Suppl. 7 (1987)
- Maleic hydrazide 4 (1974) (corr. 42); Suppl. 7 (1987)
- Malonaldehyde36 (1985); Suppl. 7 (1987); 71 (1999)
- Malondialdehyde (see Malonaldehyde)
- Maneb 12 (1976); Suppl. 7 (1987)
- Man-made mineral fibres (see Man-made vitreous fibres)

- Man-made vitreous fibres43 (1988); 81 (2002)
- Mannomustine..... 9 (1975); Suppl. 7 (1987)
- Mate51 (1991)
- MCPA30 (1983)
(see also Chlorophenoxy herbicides; Chlorophenoxy herbicides, occupational exposures to)
- MeA- α -C 40,(1986); Suppl. 7 (1987)
- Medphalan 9 (1975); Suppl. 7 (1987)
- Medroxyprogesterone acetate.....6 (1974); 21 (1979) (corr. 42); Suppl. 7 (1987); 72 (1999)
- Megestrol acetate Suppl. 7 (1987); 72 (1999)
- MelQ40 (1986); Suppl. 7 (1987); 56 (1993)
- MelQx 40 (1986); Suppl. 7 (1987) 56 (1993)
- Melamine 39(1986); Suppl. 7 (1987); 73 (1999)
- Melphalan 9 (1975); Suppl. 7 (1987); 100A (2012)
- 6-Mercaptopurine.....26 (1981); Suppl. 7(1987)
- Mercuric chloride (see Mercury and mercury compounds)
- Mercury and mercury compounds58 (1993)
- Merphalan 9 (1975); Suppl. 7 (1987)
- Mestranol.....6 (1974); 21 (1979) (corr. 42); Suppl. 7 (1987); 72 (1999)
- Metabisulfites (see Sulfur dioxide and some sulfites, bisulfites and metabisulfites)
- Metallic mercury (see Mercury and mercury compounds)
- Methanearsonic acid, disodium salt (see Arsenic and arsenic compounds)
- Methanearsonic acid, monosodium salt (see Arsenic and arsenic compounds)
- Methimazole.....79 (2001)
- Methotrexate267 (1981); Suppl. 7 (1987)
- Methoxsalen (see 8-Methoxypsoralen)
- Methoxychlor 5 (1974); 20 (1979); Suppl. 7 (1987)
- Methoxyflurane (see Anaesthetics, volatile)
- 5-Methoxypsoralen407 (1986); Suppl. 7 (1987)
- 8-Methoxypsoralen (see also 8-Methoxypsoralen plus ultraviolet radiation)24 (1980)
- 8-Methoxypsoralen plus ultraviolet radiation..... Suppl. 73 (1987); 100A (2012)
- Methyl acrylate.....19 (1979); 39 (1986); Suppl. 7 (1987); 71 (1999)
- 5-Methylangelicin plus ultraviolet radiation Suppl. 7 (1987)
(see also Angelicin and some synthetic derivatives)
- 2-Methylaziridine 9 (1975); Suppl. 7 (1987); 71 (1999)
- Methylazoxymethanol acetate (see also Cycasin) 1 (1972); 10 (1976); Suppl. 7 (1987)
- Methyl bromide.....41 (1986) (corr. 45); Suppl. 7 (1987); 71 (1999)
- Methyl tert-butyl ether73 (1999)
- Methyl carbamate..... 12 (1976); Suppl. 7 (1987)
- Methyl-CCNU (see 1-(2-Chloroethyl)-3-(4-methylcyclohexyl)-1-nitrosourea)
- Methyl chloride41 (1986); Suppl. 7 (1987); 71 (1999)
- 1-, 2-, 3-, 4-, 5- and 6-Methylchrysenes32 (1983); Suppl. 7 (1987); 92 (2010)
- N-Methyl-N,4-dinitrosoaniline 1 (1972); Suppl. 7 (1987)
- 4,4'-Methylene bis(2-chloroaniline) 4 (1974) (corr. 42); Suppl. 7 (1987); 57 (1993); 100F (2012)
- 4,4'-Methylene bis(N,N-dimethyl)benzenamine..... 27 (1982); Suppl. 7 (1987)
- 4,4'-Methylene bis(2-methylaniline)..... 4 (1974); Suppl. 7 (1987)
- 4,4'-Methylenedianiline 4 (1974) (corr. 42); 39 (1986); Suppl. 7 (1987)

4,4'-Methylenediphenyl diisocyanate	19 (1979); Suppl. 7 (1987); 71 (1999)
Methyleugenol	101 (2012)
2-Methylfluoranthene	32 (1983); Suppl. 7 (1987); 92 (2010)
3-Methylfluoranthene	32 (1983); Suppl. 7 (1987); 92 (2010)
Methylglyoxal	51 (1991)
2-Methylimidazole	101 (2012)
4-Methylimidazole	101 (2012)
Methyl iodide	15 (1977); 41 (1986); Suppl. 7 (1987); 71 (1999)
Methyl isobutyl ketone	101 (2012)
Methylmercury chloride (see Mercury and mercury compounds)	
Methylmercury compounds (see Mercury and mercury compounds)	
Methyl methacrylate	19 (1979); Suppl. 7 (1987); 60 (1994)
Methyl methanesulfonate	7 (1974); Suppl. 7 (1987); 71 (1999)
2-Methyl-1-nitroanthraquinone	27 (1982); Suppl. 7 (1987)
<i>N</i> -Methyl- <i>N'</i> -nitro- <i>N</i> -nitrosoguanidine	4 (1974); Suppl. 7 (1987)
3-Methylnitrosaminopropionaldehyde [see 3-(<i>N</i> -Nitrosomethylamino)-propionaldehyde]	
3-Methylnitrosaminopropionitrile [see 3-(<i>N</i> -Nitrosomethylamino)-propionitrile]	
4-(Methylnitrosamino)-4-(3-pyridyl)-1-butanal [see 4-(<i>N</i> -Nitrosomethyl-amino)-4-(3-pyridyl)-1-butanal]	
4-(Methylnitrosamino)-1-(3-pyridyl)-1-butanone [see 4-(<i>N</i> -Nitrosomethyl-amino)-1-(3-pyridyl)-1-butanone]	
<i>N</i> -Methyl- <i>N</i> -nitrosourea	1 (1972); 17 (1978); Suppl. 7 (1987)
<i>N</i> -Methyl- <i>N</i> -nitrosourethane	4 (1974); Suppl. 7 (1987)
<i>N</i> -Methylolacrylamide	60 (1994)
Methyl parathion	30 (1983); Suppl. 7 (1987)
1-Methylphenanthrene	32 (1983); Suppl. 7 (1987); 92 (2010)
7-Methylpyrido[3,4- <i>c</i>]psoralen	40 (1986); Suppl. 7 (1987)
Methyl red	8 (1975); Suppl. 7 (1987)
Methyl selenac (see also Selenium and selenium compounds)	12 (1976); Suppl. 7 (1987)
α -Methylstyrene	101 (2012)
Methylthiouracil	7 (1974); Suppl. 7 (1987); 79 (2001)
Metronidazole	13 (1977); Suppl. 7 (1987)
Microcystin-LR	94 (2010)
Microcystis extracts	94 (2010)
Mineral oils	3 (1973); 33 (1984) (corr. 42); Suppl. 7 (1987); 100F (2012)
Mirex	5 (1974); 20 (1979) (corr. 42); Suppl. 7 (1987)
Mists and vapours from sulfuric acid and other strong inorganic acids	54 (1992); 100F (2012)
Mitomycin C	10 (1976); Suppl. 7 (1987)
Mitoxantrone	76 (2000)
MNNG (see <i>N</i> -Methyl- <i>N'</i> -nitro- <i>N</i> -nitrosoguanidine)	
MOCA (see 4,4'-Methylene bis(2-chloroaniline))	
Modacrylic fibres	19 (1979); Suppl. 7 (1987)
Monochloramine (see Chloramine)	
3-Monochloro-1,2-propanediol	101 (2012)
Monocrotaline	10 (1976); Suppl. 7 (1987)
Monuron	12 (1976); Suppl. 7 (1987); 53 (1991)
MOPP and other combined chemotherapy including alkylating agents	Suppl. 7 (1987); 100A (2012)
Mordanite (see Zeolites)	

Morinda officinalis (see also Traditional herbal medicines)	82 (2002)
Morpholine	47 (1989); 71 (1999)
5-(Morpholinomethyl)-3-[(5-nitrofurfurylidene)amino]-2-oxazolidinone.....	7 (1974); Suppl. 7 (1987)
Musk ambrette.....	65 (1996)
Musk xylene	65 (1996)
Mustard gas.....	9 (1975) (corr. 42); Suppl. 7 (1987); 100F (2012)
Myleran (see 1,4-Butanediol dimethanesulfonate)	

N

Nafenopin	24 (1980); Suppl. 7 (1987)
Naphthalene.....	82 (2002)
1,5-Naphthalenediamine	27 (1982); Suppl. 7 (1987)
1,5-Naphthalene diisocyanate	19 (1979); Suppl. 7 (1987); 71 (1999)
Naphtho[1,2- <i>b</i>]fluoranthene.....	92 (2010)
Naphtho[2,1- <i>a</i>]fluoranthene.....	92 (2010)
Naphtho[2,3- <i>e</i>]pyrene.....	92, (2010)
1-Naphthylamine	4 (1974) (corr. 42); Suppl. 7 (1987)
2-Naphthylamine	4 (1974); Suppl. 7 (1987); 100F (2012)
1-Naphthylthiourea	30 (1983); Suppl. 7 (1987)
Neutron radiation	75 (2000); 100D (2012)
Nickel acetate (see Nickel and nickel compounds)	
Nickel ammonium sulfate (see Nickel and nickel compounds)	
Nickel and nickel compounds (see also Implants, surgical)	2 (1973) (corr. 42); 11 (1976); Suppl. 7 (1987) (corr. 45); 49 (1990) (corr. 67); 100C (2012)
Nickel carbonate (see Nickel and nickel compounds)	
Nickel carbonyl (see Nickel and nickel compounds)	
Nickel chloride (see Nickel and nickel compounds)	
Nickel-gallium alloy (see Nickel and nickel compounds)	
Nickel hydroxide (see Nickel and nickel compounds)	
Nickelocene (see Nickel and nickel compounds)	
Nickel oxide (see Nickel and nickel compounds)	
Nickel subsulfide (see Nickel and nickel compounds)	
Nickel sulfate (see Nickel and nickel compounds)	
Niridazole.....	13 (1977); Suppl. 7 (1987)
Nithiazide.....	31 (1983); Suppl. 7 (1987)
Nitrate or nitrite, ingested, under conditions that result in endogenous nitrosation	94 (2010)
Nitrilotriacetic acid and its salts	48 (1990); 73 (1999)
Nitrite (see Nitrate or nitrite)	
5-Nitroacenaphthene	16 (1978); Suppl. 7 (1987)
5-Nitro- <i>ortho</i> -anisidine	27 (1982); Suppl. 7 (1987)
2-Nitroanisole	65 (1996)
9-Nitroanthracene.....	33 (1984); Suppl. 7 (1987)
7-Nitrobenz[<i>a</i>]anthracene	46 (1989)
Nitrobenzene	65 (1996)

6-Nitrobenzo[<i>a</i>]pyrene	33 (1984); Suppl. 7 (1987); 46 (1989)
4-Nitrobiphenyl	4 (1974); Suppl. 7 (1987)
6-Nitrochrysene	33 (1984); Suppl. 7 (1987); 46 (1989)
Nitrofen, technical-grade	30 (1983); Suppl. 7 (1987)
3-Nitrofluoranthene	33 (1984); Suppl. 7 (1987)
2-Nitrofluorene	46 (1989)
Nitrofural	7 (1974); Suppl. 7 (1987); 50 (1990)
5-Nitro-2-furaldehyde semicarbazone (see Nitrofural)	
Nitrofurantoin	50 (1990)
Nitrofurazone (see Nitrofural)	
1-[(5-Nitrofurfurylidene)amino]-2-imidazolidinone	7 (1974); Suppl. 7 (1987)
N-[4-(5-Nitro-2-furyl)-2-thiazolyl]acetamide	1 (1972); 7 (1974); Suppl. 7 (1987)
Nitrogen mustard	9 (1975); Suppl. 7 (1987)
Nitrogen mustard <i>N</i> -oxide	9 (1975); Suppl. 7 (1987)
Nitromethane	77 (2000)
1-Nitronaphthalene	46 (1989)
2-Nitronaphthalene	46 (1989)
3-Nitroperylene	46 (1989)
2-Nitro- <i>para</i> -phenylenediamine (see 1,4-Diamino-2-nitrobenzene)	
2-Nitropropane	29 (1982); Suppl. 7 (1987); 71 (1999)
1-Nitropyrene	33 (1984); Suppl. 7 (1987); 46 (1989)
2-Nitropyrene	46 (1989)
4-Nitropyrene	46 (1989)
<i>N</i> -Nitrosatable drugs	24 (1980) (corr. 42)
<i>N</i> -Nitrosatable pesticides	30 (1983)
<i>N'</i> -Nitrosoanabasine (NAB)	37 (1985); Suppl. 7 (1987); 89 (2007)
<i>N'</i> -Nitrosoanatabine (NAT)	37 (1985); Suppl. 7 (1987); 89 (2007)
<i>N</i> -Nitrosodi- <i>n</i> -butylamine	4 (1974); 17 (1978); Suppl. 7 (1987)
<i>N</i> -Nitrosodiethanolamine	17 (1978); Suppl. 7 (1987); 77 (2000)
<i>N</i> -Nitrosodiethylamine	1 (1972) (corr. 42); 17 (1978) (corr. 42); Suppl. 7 (1987)
<i>N</i> -Nitrosodimethylamine	1 (1972); 17 (1978) (corr. 42); Suppl. 7 (1987)
<i>N</i> -Nitrosodiphenylamine	27 (1982); Suppl. 7 (1987)
<i>para</i> -Nitrosodiphenylamine	27 (1982) (corr. 42); Suppl. 7 (1987)
<i>N</i> -Nitrosodi- <i>n</i> -propylamine	17 (1978); Suppl. 7 (1987)
<i>N</i> -Nitroso- <i>N</i> -ethylurea (see <i>N</i> -Ethyl- <i>N</i> -nitroso-urea)	
<i>N</i> -Nitrosofolic acid	17 (1978); Suppl. 7 (1987)
<i>N</i> -Nitrosoguvacine	37 (1985); Suppl. 7 (1987); 85 (2004)
<i>N</i> -Nitrosoguvacolone	37 (1985); Suppl. 7 (1987); 85 (2004)
<i>N</i> -Nitrosohydroxyproline	17 (1978); Suppl. 7 (1987)
3-(<i>N</i> -Nitrosomethylamino)propionaldehyde	37 (1985); Suppl. 7 (1987); 85 (2004)
3-(<i>N</i> -Nitrosomethylamino)propionitrile	37 (1985); Suppl. 7 (1987); 85 (2004)
4-(<i>N</i> -Nitrosomethylamino)-4-(3-pyridyl)-1-butanol	37 (1985); Suppl. 7 (1987)
4-(<i>N</i> -Nitrosomethylamino)-1-(3-pyridyl)-1-butanone (NNK)	37 (1985); Suppl. 7 (1987); 89 (2007); 100E (2012)
<i>N</i> -Nitrosomethylethylamine	17 (1978); Suppl. 7 (1987)
<i>N</i> -Nitroso- <i>N</i> -methylurea (see <i>N</i> -Methyl- <i>N</i> -nitroso-urea)	

- N*-Nitroso-*N*-methylurethane (see *N*-Methyl-*N*-nitrosourethane)
- N*-Nitrosomethylvinylamine 17 (1978); Suppl. 7 (1987)
- N*-Nitrosomorpholine..... 17 (1978); Suppl. 7 (1987)
- N*'-Nitrosornicotine (NNN)..... 17 (1978); 37 (1985); Suppl. 7 (1987); 89 (2007); 100E (2012)
- N*-Nitrosopiperidine 17 (1978); Suppl. 7 (1987)
- N*-Nitrosoproline 17 (1978); Suppl. 7 (1987)
- N*-Nitrosopyrrolidine 17 (1978); Suppl. 7 (1987)
- N*-Nitrososarcosine 17 (1978); Suppl. 7 (1987)
- Nitrosoureas, chloroethyl (see Chloroethyl nitrosoureas)
- 5-Nitro-*ortho*-toluidine 48 (1990)
- 2-Nitrotoluene 65 (1996); 101 (2012)
- 3-Nitrotoluene 65 (1996)
- 4-Nitrotoluene 65 (1996)
- Nitrous oxide (see Anaesthetics, volatile)
- Nitrovin..... 31 (1983); Suppl. 7 (1987)
- Nivalenol (see Toxins derived from *Fusarium graminearum*, *F. culmorum* and *F. crookwellense*)
- NNK (see 4-(*N*-Nitrosomethylamino)-1-(3-pyridyl)-1-butanone)
- NNN (see *N*'-Nitrosornicotine)
- Nodularins 94 (2010)
- Nonsteroidal estrogens..... Suppl. 7 (1987)
- Norethisterone..... 6 (1974); 21 (1979); Suppl. 7 (1987); 72 (1999)
- Norethisterone acetate 72 (1999)
- Norethynodrel 6 (1974); 21 (1979) (corr. 42); Suppl. 7 (1987); 72 (1999)
- Norgestrel 6 (1974); 21 (1979); Suppl. 7 (1987); 72 (1999)
- Nylon 6 19 (1979); Suppl. 7 (1987)

O

- Ochratoxin A..... 10 (1976); 31 (1983) (corr. 42); Suppl. 7 (1987); 56 (1993)
- Oil Orange SS 8 (1975); Suppl. 7 (1987)
- Oestrogen and Oestrogen-type compounds (see Estrogen)
- Opisthorchis felineus*, infection with 61 (1994)
- Opisthorchis viverrini*, infection with 61 (1994); 100B (2012)
- Oral contraceptives, sequential (see Sequential oral contraceptives)
- Orange I 8 (1975); Suppl. 7 (1987)
- Orange G 8 (1975); Suppl. 7 (1987)
- Organic lead compounds..... Suppl. 7 (1987); 87 (2006)
- Organolead compounds (see Organic lead compounds)
- Oxazepam 13 (1977); Suppl. 7 (1987); 66 (1996)
- Oxymetholone (see also Androgenic (anabolic) steroids) 13 (1977)
- Oxyphenbutazone 13 (1977); Suppl. 7 (1987)

P

Paint manufacture and painting, occupational exposures in	47 (1989); 98 (2010); 100F (2012)
Palygorskite	42 (1987); Suppl. 7 (1987); 68 (1997)
Panfuran S (see also Dihydroxymethylfuratrizine)	24 (1980); Suppl. 7 (1987)
Paper manufacture (see Pulp and paper manufacture)	
Paracetamol	50 (1990); 73 (1999)
Parasorbic acid	10 (1976) (corr. 42); Suppl. 7 (1987)
Parathion	30 (1983); Suppl. 7 (1987)
Patulin	10 (1976); 40 (1986); Suppl. 7 (1987)
Paving and roofing with coal-tar pitch	92 (2010)
Penicillic acid	10 (1976); Suppl. 7 (1987)
Pentachloroethane	41 (1986); Suppl. 7 (1987); 71 (1999)
Pentachloronitrobenzene (see Quintozene)	
Pentachlorophenol	20 (1979); 53 (1991)
(see also Chlorophenols; Chlorophenols, occupational exposures to; Polychlorophenols and their sodium salts)	
Permethrin	53 (1991)
Perylene	32 (1983); Suppl. 7 (1987); 92 (2010)
Petasitenine	31 (1983); Suppl. 7 (1987)
Petasites japonicus (see also Pyrrolizidine alkaloids)	10 (1976)
Petroleum refining, occupational exposures in	45 (1989)
Petroleum solvents	47 (1989)
Phenacetin	13 (1977); 24 (1980); Suppl. 7 (1987); 100A (2012)
Phenanthrene	32 (1983); Suppl. 7 (1987); 92 (2010)
Phenazopyridine hydrochloride	8 (1975); 24 (1980) (corr. 42); Suppl. 7 (1987)
Phenelzine sulfate	24 (1980); Suppl. 7 (1987)
Phenicarbazide	12 (1976); Suppl. 7 (1987)
Phenobarbital and its sodium salt	13 (1977); Suppl. 7 (1987); 79 (2001)
Phenol	47 (1989) (corr. 50); 71 (1999)
Phenolphthalein	76 (2000)
Phenoxyacetic acid herbicides (see Chlorophenoxy herbicides)	
Phenoxybenzamine hydrochloride	9 (1975); 24 (1980); Suppl. 7 (1987)
Phenylbutazone	13 (1977); Suppl. 7 (1987)
meta-Phenylenediamine	16 (1978); Suppl. 7 (1987)
para-Phenylenediamine	16 (1978); Suppl. 7 (1987)
Phenyl glycidyl ether (see also Glycidyl ethers)	71 (1999)
N-Phenyl-2-naphthylamine	16 (1978) (corr. 42); Suppl. 7 (1987)
ortho-Phenylphenol	30 (1983); Suppl. 7 (1987); 73 (1999)
Phenytoin	13 (1977); Suppl. 7 (1987); 66 (1996)
Phillipsite (see Zeolites)	
PhIP	56 (1993)
Phosphorus-32 as phosphate	100D (2012)
Picene	92 (2010)
Pickled vegetables	56 (1993)
Picloram	53 (1991)

- Piperazine oestrone sulfate (see Conjugated estrogens)
- Piperonyl butoxide 30 (1983); Suppl. 7 (1987)
- Pitches, coal-tar (see Coal-tar pitches)
- Plutonium-239 100D (2012)
- Polyacrylic acid 19 (1979); Suppl. 7 (1987)
- Polybrominated biphenyls 18 (1978); 41 (1986); Suppl. 7 (1987)
- Polychlorinated biphenyls 7 (1974); 18 (1978) (corr. 42); Suppl. 7 (1987)
- Polychlorinated camphenes (see Toxaphene)
- Polychlorinated dibenzo-*para*-dioxins
(other than 2,3,7,8-tetrachlorodibenzodioxin) 69 (1997)
- Polychlorinated dibenzofurans 69 (1997)
- Polychlorophenols and their sodium salts 71 (1999)
- Polychloroprene 19 (1979); Suppl. 7 (1987)
- Polyestradiol phosphate (see Estradiol-17 β)
- Polyethylene (see also Implants, surgical) 19 (1979); Suppl. 7 (1987)
- Poly(glycolic acid) (see Implants, surgical)
- Polymethylene polyphenyl isocyanate 19 (1979); Suppl. 7 (1987)
(see also 4,4'-Methylenediphenyl diisocyanate)
- Polymethyl methacrylate (see also Implants, surgical) 19 (1979); Suppl. 7 (1987)
- Polypropylene (see also Implants, surgical) 19 (1979); Suppl. 7 (1987)
- Polystyrene (see also Implants, surgical) 19 (1979); Suppl. 7 (1987)
- Polytetrafluoroethylene (see also Implants, surgical) 19 (1979); Suppl. 7 (1987)
- Polyurethane foams (see also Implants, surgical) 19 (1979); Suppl. 7 (1987)
- Polyvinyl acetate (see also Implants, surgical) 19 (1979); Suppl. 7 (1987)
- Polyvinyl alcohol (see also Implants, surgical) 19 (1979); Suppl. 7 (1987)
- Polyvinyl chloride (see also Implants, surgical) 7 (1974); 19 (1979); Suppl. 7 (1987)
- Polyvinyl pyrrolidone 19 (1979); Suppl. 7 (1987); 71 (1999)
- Ponceau MX 8 (1975); Suppl. 7 (1987)
- Ponceau 3R 8 (1975); Suppl. 7 (1987)
- Ponceau SX 8 (1975); Suppl. 7 (1987)
- Post-menopausal estrogen therapy Suppl. 7 (1987); 72 (1999); 100A (2012)
- Potassium arsenate (see Arsenic and arsenic compounds)
- Potassium arsenite (see Arsenic and arsenic compounds)
- Potassium bis(2-hydroxyethyl)dithiocarbamate 12 (1976); Suppl. 7 (1987)
- Potassium bromate 40 (1986); Suppl. 7 (1987); 73 (1999)
- Potassium chromate (see Chromium and chromium compounds)
- Potassium dichromate (see Chromium and chromium compounds)
- Prazepam 66 (1996)
- Prednimustine 50 (1990)
- Prednisone 26 (1981); Suppl. 7 (1987)
- Printing processes and printing inks 65 (1996)
- Procarbazine hydrochloride 26 (1981); Suppl. 7 (1987)
- Proflavine salts 24 (1980); Suppl. 7 (1987)
- Progesterone (see also Progestins; Combined oral contraceptives) 6 (1974); 21 (1979) (corr. 42)
- Progestins (see Progestogens)
- Progestogens Suppl. 7 (1987); 72 (1999)

Pronetalol hydrochloride	13 (1977) (corr. 42); Suppl. 7 (1987)
1,3-Propane sultone	4 (1974) (corr. 42); Suppl. 7 (1987); 71 (1999)
Propham	12 (1976); Suppl. 7 (1987)
β -Propiolactone	4 (1974) (corr. 42); Suppl. 7 (1987); 71 (1999)
<i>n</i> -Propyl carbamate	12 (1976); Suppl. 7 (1987)
Propylene	19 (1979); Suppl. 7 (1987); 60 (1994)
Propyleneimine (see 2-Methylaziridine)	
Propylene oxide	11 (1976); 36 (1985) (corr. 42); Suppl. 7 (1987); 60 (1994)
Propylthiouracil	7 (1974); Suppl. 7 (1987); 79 (2001)
Ptaquiloside (see also Bracken fern)	40 (1986); Suppl. 7 (1987)
Pulp and paper manufacture	25 (1981); Suppl. 7 (1987)
Pyrene	32 (1983); Suppl. 7 (1987); 92 (2010)
Pyridine	77 (2000)
Pyrido[3,4- <i>c</i>]psoralen	40 (1986); Suppl. 7 (1987)
Pyrimethamine	13 (1977); Suppl. 7 (1987)
Pyrrolizidine alkaloids (see Hydroxysenkirkine; Isatidine; Jacobine; Lasiocarpine; Monocrotaline; Retrorsine; Riddelliine; Seneciphylline; Senkirkine)	

Q

Quartz (see Crystalline silica)	
Quercetin (see also Bracken fern)	31 (1983); Suppl. 7 (1987); 73 (1999)
<i>para</i> -Quinone	15 (1977); Suppl. 7 (1987); 71 (1999)
Quintozene	5 (1974); Suppl. 7 (1987)

R

Radiation (see gamma-radiation, neutrons, ultraviolet radiation, X-radiation)	
Radiofrequency electromagnetic fields	102 (2013)
Radionuclides, internalized, that emit α -particles	78 (2001); 100D (2012)
Radionuclides, internalized, that emit β -particles	78 (2001); 100D (2012)
Radioisotopes of iodine, short-lived, including Iodine-131	100D (2012)
Radium-224, radium-226, radium-228	100D (2012)
Radon-222 with its decay products	43 (1988) (corr. 45); 100D (2012)
Refractory ceramic fibres (see Man-made vitreous fibres)	
Reserpine	10 (1976); 24 (1980) (corr. 42); Suppl. 7 (1987)
Resorcinol	15 (1977); Suppl. 7 (1987); 71 (1990)
Retrorsine	10 (1976); Suppl. 7 (1987)
Rhodamine B	16 (1978); Suppl. 7 (1987)
Rhodamine 6G	16 (1978); Suppl. 7 (1987)
Riddelliine	10 (1976); Suppl. 7 (1987); 82 (2002)
Rifampicin	24 (1980); Suppl. 7 (1987)
Ripazepam	66 (1996)

Rock (stone) wool (see Man-made vitreous fibres)
 Rubber industry 28 (1982) (corr. 42); Suppl. 7 (1987) ; 100F (2012)
Rubia tinctorum (see also Madder root; Traditional herbal medicines) 82 (2002)
 Rugulosin 40 (1986); Suppl. 7 (1987)

S

Saccharated iron oxide 2 (1973); Suppl. 7 (1987)
 Saccharin and its salts 22 (1980) (corr. 42); Suppl. 7 (1987); 73 (1999)
 Safrole 1 (1972); 10 (1976); Suppl. 7 (1987)
 Salted fish, Chinese-style 56 (1993); 100E (2012)
 Sawmill industry, including logging
 (see Lumber and sawmill industry, including logging)
 Scarlet Red 8 (1975); Suppl. 7 (1987)
Schistosoma haematobium, infection with 61 (1994); 100B (2012)
Schistosoma japonicum, infection with 61 (1994)
Schistosoma mansoni, infection with 61 (1994)
 Selenium and selenium compounds 9 (1975) (corr. 42); Suppl. 7 (1987)
 Selenium dioxide (see Selenium and selenium compounds)
 Selenium oxide (see Selenium and selenium compounds)
 Semicarbazide hydrochloride 12 (1976) (corr. 42); Suppl. 7 (1987)
Senecio jacobaea L. (see also Pyrrolizidine alkaloids) 10 (1976)
Senecio longilobus 10 (1976); 82 (2002)
 (see also Pyrrolizidine alkaloids; Traditional herbal medicines)
Senecio riddellii (see also Traditional herbal medicines) 82 (1982)
 Seneciphylline 10 (1976); Suppl. 7 (1987)
 Senkirkine 10 (1976); 31 (1983); Suppl. 7 (1987)
 Sepiolite 42 (1987); Suppl. 7 (1987); 68 (1997)
 Sequential oral contraceptives Suppl. 7 (1987)
 (see also Estrogens, progestins and combinations)
 Shale-oils 35 (1985); Suppl. 7 (1987); 100F (2012)
 Shiftwork 98 (2010)
 Shikimic acid (see also Bracken fern) 40 (1986); Suppl. 7 (1987)
 Shoe manufacture and repair (see Boot and shoe manufacture and repair)
 Silica (see also Amorphous silica; Crystalline silica) 42 (1987); 100C (2012)
 Silicone (see Implants, surgical)
 Simazine 53 (1991); 73 (1999)
 Slag wool (see Man-made vitreous fibres)
 Sodium arsenate (see Arsenic and arsenic compounds)
 Sodium arsenite (see Arsenic and arsenic compounds)
 Sodium cacodylate (see Arsenic and arsenic compounds)
 Sodium chlorite 52 (1991)
 Sodium chromate (see Chromium and chromium compounds)
 Sodium cyclamate (see Cyclamates)
 Sodium dichromate (see Chromium and chromium compounds)

Sodium diethyldithiocarbamate	12 (1976); Suppl. 7 (1987)
Sodium equilin sulfate (see Conjugated estrogens)	
Sodium estrone sulfate (see Conjugated estrogens)	
Sodium fluoride (see Fluorides)	
Sodium monofluorophosphate (see Fluorides)	
Sodium <i>ortho</i> -phenylphenate	30 (1983); Suppl. 7 (1987); 73 (1999)
(see also <i>ortho</i> -Phenylphenol)	
Sodium saccharin (see Saccharin)	
Sodium selenate (see Selenium and selenium compounds)	
Sodium selenite (see Selenium and selenium compounds)	
Sodium silicofluoride (see Fluorides)	
Solar radiation	55 (1992); 100D (2012)
Soots	3 (1973); 35 (1985); Suppl. 7 (1987); 100F (2012)
Special-purpose glass fibres such as E-glass and '475' glass fibres (see Man-made vitreous fibres)	
Spironolactone.....	24 (1980); Suppl. 7 (1987); 79 (2001)
Stannous fluoride (see Fluorides)	
Static electric fields.....	80 (2002)
Static magnetic fields.....	80 (2002)
Steel founding (see Iron and steel founding)	
Steel, stainless (see Implants, surgical)	
Sterigmatocystin	1 (1972); 10(1976); Suppl. 7 (1987)
Steroidal estrogens	Suppl. 7 (1987)
Streptozotocin	4 (1974); 17 (1978); Suppl. 7 (1987)
Strobane® (see Terpene polychlorinates)	
Strong-inorganic-acid mists containing sulfuric acid (see Mists and vapours from sulfuric acid and other strong inorganic acids)	
Strontium chromate (see Chromium and chromium compounds)	
Styrene	19 (1979) (corr. 42); Suppl. 7 (1987); 60 (1994) (corr. 65); 82 (2002)
Styrene-acrylonitrile copolymers	19 (1979); Suppl. 7 (1987)
Styrene-butadiene copolymers	19 (1979); Suppl. 7 (1987)
Styrene-7,8-oxide	11 (1976); 19 (1979); 36 (1985); Suppl. 7 (1987); 60 (1994)
Succinic anhydride	15 (1977); Suppl. 7 (1987)
Sudan I	8 (1975); Suppl. 7 (1987)
Sudan II	8 (1975); Suppl. 7 (1987)
Sudan III	8 (1975); Suppl. 7 (1987)
Sudan Brown RR.....	8 (1975); Suppl. 7 (1987)
Sudan Red 7B	8 (1975); Suppl. 7 (1987)
Sulfadimidine (see Sulfamethazine)	
Sulfafurazole	24 (1980); Suppl. 7 (1987)
Sulfallate.....	30 (1983); Suppl. 7 (1987)
Sulfamethazine and its sodium salt	79 (2001)
Sulfamethoxazole	24 (1980); Suppl. 7 (1987); 79 (2001)
Sulfites (see Sulfur dioxide and some sulfites, bisulfites and metabisulfites)	
Sulfur dioxide and some sulfites, bisulfites and metabisulfites.....	54 (1992)
Sulfur mustard (see Mustard gas)	
Sulfuric acid and other strong inorganic acids, occupational exposures to mists and vapours from.....	54 (1992)

Sulfur trioxide	54 (1992)
Sulphisoxazole (see Sulfafurazole)	
Sunset Yellow FCF	8 (1975); Suppl. 7 (1987)
Symphytine	31 (1983); Suppl. 7 (1987)

T

2,4,5-T	15 (1977)
(see also Chlorophenoxy herbicides; Chlorophenoxy herbicides, occupational exposures to)	
Talc	42 (1987); Suppl. 7 (1987)
Talc, inhaled, not containing asbestos or asbestiform fibres	93 (2010)
Talc-based body powder, perineal use of	93 (2010)
Tamoxifen	66 (1996); 100A (2012)
Tannic acid	10 (1976) (corr. 42); Suppl. 7 (1987)
Tannins (see also Tannic acid)	10 (1976); Suppl. 7 (1987)
TCDD (see 2,3,7,8-Tetrachlorodibenzo- <i>para</i> -dioxin)	
TDE (see DDT)	
Tea	51 (1991)
Temazepam	66 (1996)
Teniposide	76 (2000)
Terpene polychlorinates	5 (1974); Suppl. 7 (1987)
Testosterone (see also Androgenic (anabolic) steroids)	6, (1974); 21 (1979)
Testosterone oenanthate (see Testosterone)	
Testosterone propionate (see Testosterone)	
2,2',5,5'-Tetrachlorobenzidine	27 (1982); Suppl. 7 (1987)
2,3,7,8-Tetrachlorodibenzo- <i>para</i> -dioxin	15 (1977); Suppl. 7 (1987); 69 (1997); 100F (2012)
1,1,1,2-Tetrachloroethane	41 (1986); Suppl. 7 (1987); 71 (1999)
1,1,2,2-Tetrachloroethane	20 (1979); Suppl. 7 (1987); 71 (1999)
Tetrachloroethylene	20 (1979); Suppl. 7 (1987); 63 (1995) (corr. 65)
2,3,4,6-Tetrachlorophenol (see Chlorophenols; Chlorophenols, occupational exposures to; Polychlorophenols and their sodium salts)	
Tetrachlorvinphos	30 (1983); Suppl. 7 (1987)
Tetraethyllead (see Lead and lead compounds)	
Tetrafluoroethylene	19 (1979); Suppl. 7 (1987); 71 (1999)
Tetrakis(hydroxymethyl)phosphonium salts	48 (1990); 71 (1999)
Tetramethyllead (see Lead and lead compounds)	
Tetranitromethane	65 (1996)
Textile manufacturing industry, exposures in	48 (1990) (corr. 51)
Theobromine	51 (1991)
Theophylline	51 (1991)
Thioacetamide	7 (1974); Suppl. 7 (1987)
4,4'-Thiodianiline	16 (1978); 27 (1982); Suppl. 7 (1987)
Thiotepa	9 (1975); Suppl. 7 (1987); 50 (1990); 100A (2012)
Thiouracil	7 (1974); Suppl. 7 (1987); 79 (2001)
Thiourea	7 (1974); Suppl. 7 (1987); 79 (2001)

Thiram	12 (1976); Suppl. 7 (1987); 53 (1991)
Thorium-232 (as Thorotrast)	100D (2012)
Titanium (see Implants, surgical)	
Titanium dioxide	47 (1989); 93 (2010)
Tobacco	
– Second-hand tobacco smoke	83 (2004); 100E (2012)
– Smokeless tobacco	37 (1985) (corr. 42; 52); Suppl. 7 (1987); 89 (2007); 100E (2012)
– Tobacco smoking	38 (1986) (corr. 42); Suppl. 7 (1987); 83 (2004); 100E (2012)
<i>ortho</i> -Tolidine (see 3,3'-Dimethylbenzidine)	
2,4-Toluene diisocyanate (see also Toluene diisocyanates)	19 (1979); 39 (1986)
2,6-Toluene diisocyanate (see also Toluene diisocyanates)	19 (1979); 39 (1986)
Toluene	47 (1989); 71 (1999)
Toluene diisocyanates	39 (1986) (corr. 42); Suppl. 7 (1987); 71 (1999)
Toluenes, α -chlorinated (see α -Chlorinated toluenes and benzoyl chloride)	
<i>ortho</i> -Toluenesulfonamide (see Saccharin)	
<i>ortho</i> -Toluidine	16 (1978); 27 (1982) (corr. 68); Suppl. 7 (1987); 77 (2000)
Toremifene	66 (1996)
Toxaphene	20 (1979); Suppl. 7 (1987); 79 (2001)
T-2 Toxin (see Toxins derived from <i>Fusarium sporotrichioides</i>)	
Toxins derived from <i>Fusarium graminearum</i> , <i>F. culmorum</i> and <i>F. crookwellense</i>	11 (1976); 31, 279 (1983); Suppl. 7 (1987); 56 (1993)
Toxins derived from <i>Fusarium moniliforme</i>	56 (1993)
Toxins derived from <i>Fusarium sporotrichioides</i>	31 (1983); Suppl. 7 (1987); 56 (1993)
Traditional herbal medicines	82 (2002); 100A (2012)
Tremolite (see Asbestos)	
Treosulfan	26 (1981); Suppl. 7 (1987); 100A (2012)
Triaziquone (see Tris(aziridinyl)- <i>para</i> -benzoquinone)	
Trichlorfon	30 (1983); Suppl. 7 (1987)
Trichlormethine	9 (1975); Suppl. 7 (1987); 50 (1990)
Trichloroacetic acid	63 (1995) (corr. 65); 84 (2004)
Trichloroacetonitrile (see also Halogenated acetonitriles)	71 (1999)
1,1,1-Trichloroethane	20 (1979); Suppl. 7 (1987); 71 (1999)
1,1,2-Trichloroethane	20 (1979); Suppl. 7 (1987); 52 (1991); 71 (1999)
Trichloroethylene	11 (1976); 20 (1979); Suppl. 7 (1987); 63 (1995) (corr. 65)
2,4,5-Trichlorophenol	20 (1979)
(see also Chlorophenols; Chlorophenols, occupational exposures to; Polychlorophenols and their sodium salts)	
2,4,6-Trichlorophenol	20 (1979)
(see also Chlorophenols; Chlorophenols, occupational exposures to; Polychlorophenols and their sodium salts)	
(2,4,5-Trichlorophenoxy)acetic acid (see 2,4,5-T)	
1,2,3-Trichloropropane	63 (1995)
Trichlorotriethylamine-hydrochloride (see Trichlormethine)	
T2-Trichothecene (see Toxins derived from <i>Fusarium sporotrichioides</i>)	
Tridymite (see Crystalline silica)	
Triethanolamine	77 (2000)

Triethylene glycol diglycidyl ether	11 (1976); Suppl. 7 (1987); 71 (1999)
Trifluralin	53 (1991)
4,4',6'-Trimethylangelicin plus ultraviolet radiation	Suppl. 7 (1987)
(see also Angelicin and some synthetic derivatives)	
2,4,5-Trimethylaniline	27 (1982); Suppl. 7 (1987)
2,4,6-Trimethylaniline	27 (1982); Suppl. 7 (1987)
4,5,8-Trimethylpsoralen	40 (1986); Suppl. 7 (1987)
Trimustine hydrochloride (see Trichlormethine)	
2,4,6-Trinitrotoluene.....	65 (1996)
Triphenylene.....	32 (1983); Suppl. 7 (1987); 92 (2010)
Tris(aziridiny)- <i>para</i> -benzoquinone.....	9 (1975); Suppl. 7 (1987)
Tris(1-aziridinyl)phosphine-oxide	9 (1975); Suppl. 7 (1987)
Tris(1-aziridinyl)phosphine-sulphide (see Thiotepea)	
2,4,6-Tris(1-aziridinyl)- <i>s</i> -triazine	9 (1975); Suppl. 7 (1987)
Tris(2-chloroethyl) phosphate.....	48 (1990); 71 (1999)
1,2,3-Tris(chloromethoxy)propane	15 (1977); Suppl. 7 (1987); 71 (1999)
Tris(2,3-dibromopropyl) phosphate	20 (1979); Suppl. 7 (1987); 71 (1999)
Tris(2-methyl-1-aziridinyl)phosphine-oxide.....	9 (1975); Suppl. 7 (1987)
Trp-P-1.....	31 (1983); Suppl. 7 (1987)
Trp-P-2.....	31 (1983); Suppl. 7 (1987)
Trypan blue	8 (1975); Suppl. 7 (1987)
<i>Tussilago farfara</i> L. (see also Pyrrolizidine alkaloids)	10 (1976)

U

Ultraviolet radiation	40 (1986); 55 (1992); 100D (2012)
Underground haematite mining with exposure to radon (see Haematite mining, underground)	
Uracil mustard	9 (1975); Suppl. 7 (1987)
Uranium, depleted (see Implants, surgical)	
Urethane (see Ethyl carbamate)	
UV-emitting tanning devices, use of	100D (2012)

V

Vanadium pentoxide	86 (2006)
Vat Yellow 4	48 (1990)
Vinblastine sulfate.....	26 (1981) (corr. 42); Suppl. 7 (1987)
Vincristine sulfate	26 (1981); Suppl. 7 (1987)
Vinyl acetate	19 (1979); 39 (1986); Suppl. 7, 73 (1987); 63, 443 (1995)
Vinyl bromide	19 (1979); 39 (1986); Suppl. 7 (1987); 71 (1999); 97 (2008)
Vinyl chloride	7 (1974); 19 (1979) (corr. 42); Suppl. 7 (1987); 97 (2008); 100F (2012)
Vinyl chloride-vinyl acetate copolymers.....	7 (1976); 19 (1979) (corr. 42); Suppl. 7 (1987)
4-Vinylcyclohexene.....	11 (1976); 39 (1986) Suppl. 7 (1987); 60 (1994)

4-Vinylcyclohexene diepoxide	11 (1976); Suppl. 7 (1987); 60 (1994)
Vinyl fluoride	39 (1986); Suppl. 7 (1987); 63 (1995); 97 (2008)
Vinylidene chloride	19 (1979); 39 (1986); Suppl. 7 (1987); 71 (1999)
Vinylidene chloride-vinyl chloride copolymers	19 (1979) (corr. 42); Suppl. 7 (1987)
Vinylidene fluoride	39 (1986); Suppl. 7 (1987); 71 (1999)
N-Vinyl-2-pyrrolidone	19 (1979); Suppl. 7 (1987); 71 (1999)
Vinyl toluene	60 (1994)
Vitamin K substances	76 (2000)

W

Welding	49 (1990) (corr. 52)
Wollastonite	42 (1987); Suppl. 7 (1987); 68 (1997)
Wood dust	62 (1995); 100C (2012)
Wood industries	25 (1981); Suppl. 7 (1987)

X

X-radiation	75 (2000); 100D (2012)
Xylenes	47 (1989); 71 (1999)
2,4-Xylidine	16 (1978); Suppl. 7 (1987)
2,5-Xylidine	16 (1978); Suppl. 7 (1987)
2,6-Xylidine (see 2,6-Dimethylaniline)	

Y

Yellow AB	8 (1975); Suppl. 7 (1987)
Yellow OB	8 (1975); Suppl. 7 (1987)

Z

Zalcitabine	76 (2000)
Zearalenone (see Toxins derived from <i>Fusarium graminearum</i> , <i>F. culmorum</i> and <i>F. crookwellense</i>)	
Zectran	12 (1976); Suppl. 7 (1987)
Zeolites other than erionite	68 (1997)
Zidovudine	76 (2000)
Zinc beryllium silicate (see Beryllium and beryllium compounds)	
Zinc chromate (see Chromium and chromium compounds)	
Zinc chromate hydroxide (see Chromium and chromium compounds)	
Zinc potassium chromate (see Chromium and chromium compounds)	
Zinc yellow (see Chromium and chromium compounds)	
Zineb	12 (1976); Suppl. 7 (1987)
Ziram	12 (1976); Suppl. 7 (1987); 53 (1991)

LIST OF IARC MONOGRAPHS

Volume 1

Some Inorganic Substances, Chlorinated Hydrocarbons, Aromatic Amines, N-Nitroso Compounds, and Natural Products

1972; 184 pages (out-of-print)

Volume 2

Some Inorganic and Organometallic Compounds

1973; 181 pages (out-of-print)

Volume 3

Certain Polycyclic Aromatic Hydrocarbons and Heterocyclic Compounds

1973; 271 pages (out-of-print)

Volume 4

Some Aromatic Amines, Hydrazine and Related Substances, N-Nitroso Compounds and Miscellaneous Alkylating Agents

1974; 286 pages (out-of-print)

Volume 5

Some Organochlorine Pesticides

1974; 241 pages (out-of-print)

Volume 6

Sex Hormones

1974; 243 pages (out-of-print)

Volume 7

Some Anti-Thyroid and Related Substances, Nitrofurans and Industrial Chemicals

1974; 326 pages (out-of-print)

Volume 8

Some Aromatic Azo Compounds

1975; 357 pages (out-of-print)

Volume 9

Some Aziridines, N-, S- and O-Mustards and Selenium

1975; 268 pages (out-of-print)

Volume 10

Some Naturally Occurring Substances

1976; 353 pages (out-of-print)

Volume 11

*Cadmium, Nickel, Some Epoxides,
Miscellaneous Industrial Chemicals
and General Considerations on Volatile
Anaesthetics*

1976; 306 pages (out-of-print)

Volume 12

*Some Carbamates, Thio- carbamates and
Carbazides*

1976; 282 pages (out-of-print)

Volume 13

*Some Miscellaneous Pharmaceutical
Substances*

1977; 255 pages

Volume 14

Asbestos

1977; 106 pages (out-of-print)

Volume 15

*Some Fumigants, the Herbicides 2,4-D and
2,4,5-T, Chlorinated Dibenzodioxins and
Miscellaneous Industrial Chemicals*

1977; 354 pages (out-of-print)

Volume 16

*Some Aromatic Amines and Related Nitro
Compounds—Hair Dyes, Colouring
Agents and Miscellaneous Industrial
Chemicals*

1978; 400 pages

Volume 17

Some N-Nitroso Compounds

1978; 365 pages

Volume 18

*Polychlorinated Biphenyls and
Polybrominated Biphenyls*

1978; 140 pages (out-of-print)

Volume 19

*Some Monomers, Plastics and Synthetic
Elastomers, and Acrolein*

1979; 513 pages (out-of-print)

Volume 20

Some Halogenated Hydrocarbons

1979; 609 pages (out-of-print)

Volume 21

Sex Hormones (II)

1979; 583 pages

Volume 22

Some Non-Nutritive Sweetening Agents

1980; 208 pages

Volume 23

Some Metals and Metallic Compounds

1980; 438 pages (out-of-print)

Volume 24

Some Pharmaceutical Drugs

1980; 337 pages

Volume 25

Wood, Leather and Some Associated Industries

1981; 412 pages

Volume 26

Some Antineoplastic and Immunosuppressive Agents

1981; 411 pages (out-of-print)

Volume 27

Some Aromatic Amines, Anthraquinones and Nitroso Compounds, and Inorganic Fluorides Used in Drinking-water and Dental Preparations

1982; 341 pages (out-of-print)

Volume 28

The Rubber Industry

1982; 486 pages (out-of-print)

Volume 29

Some Industrial Chemicals and Dyestuffs

1982; 416 pages (out-of-print)

Volume 30

Miscellaneous Pesticides

1983; 424 pages (out-of-print)

Volume 31

Some Food Additives, Feed Additives and Naturally Occurring Substances

1983; 314 pages (out-of-print)

Volume 32

Polynuclear Aromatic Compounds, Part 1: Chemical, Environmental and Experimental Data

1983; 477 pages (out-of-print)

Volume 33

Polynuclear Aromatic Compounds, Part 2: Carbon Blacks, Mineral Oils and Some Nitroarenes

1984; 245 pages (out-of-print)

Volume 34

Polynuclear Aromatic Compounds, Part 3: Industrial Exposures in Aluminium Production, Coal Gasification, Coke Production, and Iron and Steel Founding

1984; 219 pages (out-of-print)

Volume 35

Polynuclear Aromatic Compounds, Part 4: Bitumens, Coal-tars and Derived Products, Shale-oils and Soots

1985; 271 pages

Volume 36

Allyl Compounds, Aldehydes, Epoxides and Peroxides

1985; 369 pages

Volume 37

*Tobacco Habits Other than Smoking; Betel-
Quid and Areca-Nut Chewing; and Some
Related Nitrosamines*

1985; 291 pages (out-of-print)

Volume 38

Tobacco Smoking

1986; 421 pages

Volume 39

*Some Chemicals Used in Plastics and
Elastomers*

1986; 403 pages (out-of-print)

Volume 40

*Some Naturally Occurring and Synthetic
Food Components, Furocoumarins and
Ultraviolet Radiation*

1986; 444 pages (out-of-print)

Volume 41

*Some Halogenated Hydrocarbons and
Pesticide Exposures*

1986; 434 pages (out-of-print)

Volume 42

Silica and Some Silicates

1987; 289 pages

Volume 43

Man-Made Mineral Fibres and Radon

1988; 300 pages (out-of-print)

Volume 44

Alcohol Drinking

1988; 416 pages

Volume 45

*Occupational Exposures in Petroleum
Refining; Crude Oil and Major Petroleum
Fuels*

1989; 322 pages

Volume 46

*Diesel and Gasoline Engine Exhausts and
Some Nitroarenes*

1989; 458 pages

Volume 47

*Some Organic Solvents, Resin Monomers
and Related Compounds, Pigments
and Occupational Exposures in Paint
Manufacture and Painting*

1989; 535 pages (out-of-print)

Volume 48

*Some Flame Retardants and Textile
Chemicals, and Exposures in the Textile
Manufacturing Industry*

1990; 345 pages

Volume 49

Chromium, Nickel and Welding

1990; 677 pages

Volume 50

Pharmaceutical Drugs

1990; 415 pages

Volume 51

Coffee, Tea, Mate, Methylxanthines and Methylglyoxal

1991; 513 pages

Volume 52

Chlorinated Drinking-water; Chlorination By-products; Some Other Halogenated Compounds; Cobalt and Cobalt Compounds

1991; 544 pages

Volume 53

Occupational Exposures in Insecticide Application, and Some Pesticides

1991; 612 pages

Volume 54

Occupational Exposures to Mists and Vapours from Strong Inorganic Acids; and Other Industrial Chemicals

1992; 336 pages

Volume 55

Solar and Ultraviolet Radiation

1992; 316 pages

Volume 56

Some Naturally Occurring Substances: Food Items and Constituents, Heterocyclic Aromatic Amines and Mycotoxins

1993; 599 pages

Volume 57

Occupational Exposures of Hairdressers and Barbers and Personal Use of Hair Colourants; Some Hair Dyes, Cosmetic Colourants, Industrial Dyestuffs and Aromatic Amines

1993; 428 pages

Volume 58

Beryllium, Cadmium, Mercury, and Exposures in the Glass Manufacturing Industry

1993; 444 pages

Volume 59

Hepatitis Viruses

1994; 286 pages

Volume 60

Some Industrial Chemicals

1994; 560 pages

Volume 61

Schistosomes, Liver Flukes and Helicobacter pylori

1994; 270 pages

Volume 62

Wood Dust and Formaldehyde
1995; 405 pages

Volume 63

*Dry Cleaning, Some Chlorinated Solvents
and Other Industrial Chemicals*
1995; 551 pages

Volume 64

Human Papillomaviruses
1995; 409 pages

Volume 65

*Printing Processes and Printing Inks, Carbon
Black and Some Nitro Compounds*
1996; 578 pages

Volume 66

Some Pharmaceutical Drugs
1996; 514 pages

Volume 67

*Human Immunodeficiency Viruses and
Human T-Cell Lymphotropic Viruses*
1996; 424 pages

Volume 68

*Silica, Some Silicates, Coal Dust and para-
Aramid Fibrils*
1997; 506 pages

Volume 69

*Polychlorinated Dibenzo-para-Dioxins and
Polychlorinated Dibenzofurans*
1997; 666 pages

Volume 70

*Epstein-Barr Virus and Kaposi's Sarcoma
Herpesvirus/Human Herpesvirus 8*
1997; 524 pages

Volume 71

*Re-evaluation of Some Organic Chemicals,
Hydrazine and Hydrogen Peroxide*
1999; 1586 pages

Volume 72

*Hormonal Contraception and Post-
menopausal Hormonal Therapy*
1999; 660 pages

Volume 73

*Some Chemicals that Cause Tumours of the
Kidney or Urinary Bladder in Rodents and
Some Other Substances*
1999; 674 pages

Volume 74

Surgical Implants and Other Foreign Bodies
1999; 409 pages

Volume 75

*Ionizing Radiation, Part 1, X-Radiation and
γ-Radiation, and Neutrons*

2000; 492 pages

Volume 76

*Some Antiviral and Antineoplastic Drugs,
and Other Pharmaceutical Agents*

2000; 522 pages

Volume 77

Some Industrial Chemicals

2000; 563 pages

Volume 78

*Ionizing Radiation, Part 2, Some Internally
Deposited Radionuclides*

2001; 595 pages

Volume 79

Some Thyrotropic Agents

2001; 763 pages

Volume 80

*Non-ionizing Radiation, Part 1: Static and
Extremely Low-frequency (ELF) Electric
and Magnetic Fields*

2002; 429 pages

Volume 81

Man-made Vitreous Fibres

2002; 418 pages

Volume 82

*Some Traditional Herbal Medicines, Some
Mycotoxins, Naphthalene and Styrene*

2002; 590 pages

Volume 83

Tobacco Smoke and Involuntary Smoking

2004; 1452 pages

Volume 84

*Some Drinking-Water Disinfectants and
Contaminants, including Arsenic*

2004; 512 pages

Volume 85

*Betel-quid and Areca-nut Chewing and
Some Areca-nut-derived Nitrosamines*

2004; 334 pages

Volume 86

*Cobalt in Hard Metals and Cobalt Sulfate,
Gallium Arsenide, Indium Phosphide and
Vanadium Pentoxide*

2006; 330 pages

Volume 87

Inorganic and Organic Lead Compounds

2006; 506 pages

Volume 88

*Formaldehyde, 2-Butoxyethanol and 1-tert-
Butoxypropan-2-ol*

2006; 478 pages

Volume 89

Smokeless Tobacco and Some Tobacco-specific N- Nitrosamines
2007; 626 pages

Volume 90

Human Papillomaviruses
2007; 670 pages

Volume 91

Combined Estrogen- Progestogen Contraceptives and Combined Estrogen-Progestogen Menopausal Therapy
2007; 528 pages

Volume 92

Some Non-heterocyclic Polycyclic Aromatic Hydrocarbons and Some Related Exposures
2010; 853 pages

Volume 93

Carbon Black, Titanium Dioxide, and Talc
2010; 452 pages

Volume 94

Ingested Nitrate and Nitrite, and Cyanobacterial Peptide Toxins
2010; 450 pages

Volume 95

Household Use of Solid Fuels and High-temperature Frying
2010; 430 pages

Volume 96

Alcohol Consumption
2010; 1431 pages

Volume 97

1,3-Butadiene, Ethylene Oxide and Vinyl Halides (Vinyl Fluoride, Vinyl Chloride and Vinyl Bromide)
2008; 510 pages

Volume 98

Painting, Firefighting, and Shiftwork
2010; 806 pages

Volume 99

Some Aromatic Amines, Organic Dyes, and Related Exposures
2010; 692 pages

Volume 100A

Pharmaceuticals
2012; 435 pages

Volume 100B

Biological Agents
2012; 475 pages

Volume 100C

Arsenic, Metals, Fibres, and Dusts
2012; 501 pages

Volume 100D

Radiation

2012; 341 pages

Volume 100E

Personal Habits and Indoor Combustions

2012; 575 pages

Volume 100F

Chemical Agents and Related Occupations

2012; 599 pages

Volume 101

Some Chemicals Present in Industrial and consumer products, food and drinking-water

2013 (published online: 2012); 586 pages

Volume 102

*Non-ionizing Radiation, Part 2:
Radiofrequency Electromagnetic Fields*

2013; 460 pages

Supplement No. 1

*Chemicals and Industrial Processes
Associated with Cancer in Humans (IARC
Monographs, Volumes 1 to 20)*

1979; 71 pages (out-of-print)

Supplement No. 2

*Long-term and Short-term Screening Assays
for Carcinogens: A Critical Appraisal*

1980; 426 pages (out-of-print)

(updated as IARC Scientific Publications No. 83, 1986)

Supplement No. 3

*Cross Index of Synonyms and Trade
Names in Volumes 1 to 26 of the IARC
Monographs*

1982; 199 pages (out-of-print)

Supplement No. 4

*Chemicals, Industrial Processes and
Industries Associated with Cancer in
Humans (IARC Monographs, Volumes 1
to 29)*

1982; 292 pages (out-of-print)

Supplement No. 5

*Cross Index of Synonyms and Trade
Names in Volumes 1 to 36 of the IARC
Monographs*

1985; 259 pages (out-of-print)

Supplement No. 6

*Genetic and Related Effects: An Updating of
Selected IARC Monographs from Volumes
1 to 42*

1987; 729 pages (out-of-print)

Supplement No. 7

*Overall Evaluations of Carcinogenicity: An
Updating of IARC Monographs Volumes
1–42*

1987; 440 pages (out-of-print)

Supplement No. 8

*Cross Index of Synonyms and Trade
Names in Volumes 1 to 46 of the IARC
Monographs*

1990; 346 pages (out-of-print)



This Volume of the *IARC Monographs* provides an evaluation of the carcinogenic hazards associated with exposure to electromagnetic radiation in the radiofrequency range (30 kHz to 300 GHz).

Human exposures to radiofrequency electromagnetic fields can occur from use of personal devices (e.g. mobile telephones, cordless phones, Bluetooth, and amateur radios), from occupational sources (e.g. high-frequency dielectric and induction heaters, high-powered pulsed radars), and from environmental sources (e.g. mobile-phone base stations, broadcast antennae, and medical applications). The general population receives the highest exposure from transmitters close to the body, including hand-held devices such as mobile telephones. Typical exposures to the brain from mobile-phone base stations and from television and radio stations are several orders of magnitude lower than those from second-generation GSM handsets, while 3G phones emit, on average, about 100 times less radiofrequency energy than GSM phones. Similarly, the average output power of Bluetooth wireless hands-free kits is estimated to be around 100 times less than that of mobile phones.

An *IARC Monographs Working Group* reviewed epidemiological evidence, cancer bioassays, and mechanistic and other relevant data to reach conclusions as to the carcinogenic hazard to humans from exposure to these electromagnetic fields. With "*limited evidence*" for carcinogenicity in humans based on an increased risk of glioma – a malignant brain tumour – among heavy users of mobile telephones, radiofrequency electromagnetic fields were classified as "*possibly carcinogenic to humans*" (Group 2B).

